



Australian Government

Rural Industries Research and
Development Corporation



RURAL INDUSTRIES
Research & Development Corporation

Methane Recovery and use at Grantham Piggery



DECEMBER 2012

RIRDC Publication No. 12/O64



Australian Government

**Rural Industries Research and
Development Corporation**

Methane Recovery and use at Grantham Piggery

by Alan Skerman and Gary Collman

December 2012

RIRDC Publication No. 12/064
RIRDC Project No. PRJ-005672

© 2012 Rural Industries Research and Development Corporation.
All rights reserved.

ISBN 978-1-74254-407-6
ISSN 1440-6845

Methane Recovery and use at Grantham Piggery
Publication No. 12/064
Project No. PRJ-005672

The information contained in this publication is intended for general use to assist public knowledge and discussion and to help improve the development of sustainable regions. You must not rely on any information contained in this publication without taking specialist advice relevant to your particular circumstances.

While reasonable care has been taken in preparing this publication to ensure that information is true and correct, the Commonwealth of Australia gives no assurance as to the accuracy of any information in this publication.

The Commonwealth of Australia, the Rural Industries Research and Development Corporation (RIRDC), the authors or contributors expressly disclaim, to the maximum extent permitted by law, all responsibility and liability to any person, arising directly or indirectly from any act or omission, or for any consequences of any such act or omission, made in reliance on the contents of this publication, whether or not caused by any negligence on the part of the Commonwealth of Australia, RIRDC, the authors or contributors.

The Commonwealth of Australia does not necessarily endorse the views in this publication.

This publication is copyright. Apart from any use as permitted under the *Copyright Act 1968*, all other rights are reserved. However, wide dissemination is encouraged. Requests and inquiries concerning reproduction and rights should be addressed to the RIRDC Publications Manager on phone 02 6271 4165.

Researcher Contact Details

Alan Skerman
Department of Agriculture, Fisheries and Forestry
PO Box 102
203 Tor Street
TOOWOOMBA QLD 4350

Email: Alan.Skerman@daff.qld.gov.au

In submitting this report, the researcher has agreed to RIRDC publishing this material in its edited form.

RIRDC Contact Details

Rural Industries Research and Development Corporation
Level 2, 15 National Circuit
BARTON ACT 2600

PO Box 4776
KINGSTON ACT 2604

Phone: 02 6271 4100
Fax: 02 6271 4199
Email: rirdc@rirdc.gov.au.
Web: <http://www.rirdc.gov.au>

Electronically published by RIRDC in December 2012
Print-on-demand by Union Offset Printing, Canberra at www.rirdc.gov.au
or phone 1300 634 313

Foreword

Methane is the dominant greenhouse gas emission from Australian agriculture, and has been identified as a priority area for emission reductions within the livestock sector. The potential for capture and use of methane is greatest in the intensive livestock industries, where manure management is estimated to contribute three percent of the emissions from Australian agriculture.

This project was part of the Australian Methane to Markets in Agriculture (AM2MA) program, which was managed by the Rural Industries Research and Development Corporation. The project was supported by funding from the Australian Government's Climate Change Research Program along with funding and support from industry partners: the Rural Industries Research and Development Corporation, Dairy Australia, Australian Pork Limited, Meat and Livestock Australia, the Australian Lot Feeders' Association, and the Australian Chicken Meat Federation.

This project involved upgrading the biogas extraction system installed in conjunction with a partial floating cover previously retro-fitted to the primary anaerobic pond at the Queensland Natural Pork Holdings (QNPH) Grantham piggery under an earlier AM2MA project (Project No. PRJ-003003). Following the system upgrade, the project also included the installation of a biogas reticulation pipeline to supply a water heating system, used to heat the farrowing sheds at the piggery. The biogas water heating system is expected to significantly reduce Liquid Petroleum Gas (LPG) consumption, resulting in significant energy savings.

The outcomes of this project will benefit intensive livestock producers by reducing the risk involved in establishing biogas collection and use systems. This will encourage producers to implement similar systems for the purpose of reducing their energy consumption and greenhouse gas (GHG) emissions. The technologies developed in this project will also assist pig producers with the adoption of the recently launched Carbon Farming Initiative (CFI) methodology.

The objectives of the AM2MA program are:

- development and adaptation of methane capture and use technology for application in the Australian intensive livestock industries
- reduction of the uncertainty, risk and cost of installing methane capture and use systems
- effective communication of project outcomes
- facilitation of commercialisation of on-farm systems for methane capture and use technology.

This report is an addition to the Rural Industries Research and Development Corporation's (RIRDC's) diverse range of over 2000 research publications and it forms part of our AM2MA R&D program, which aims to develop/adapt methane capture and use technology for application in Australian intensive animal industries.

Most of RIRDC's publications are available for viewing, free downloading or purchasing online at www.rirdc.gov.au. Purchases can also be made by phoning 1300 634 313.

Craig Burns
Managing Director
Rural Industries Research and Development Corporation

Acknowledgments

QNPH Grantham piggery owners, Messrs Jeremy Whitby and Graham Bourke

Piggery manager, Mr Darren Keep and piggery employees

Australian Methane to Markets in Agriculture (AM2MA) program manager, Mr Griff Rose

The Australian Government's Climate Change Research Program

Abbreviations

AGA	Australian Gas Association
AM2MA	Australian Methane to Markets in Agriculture program
APL	Australian Pork Limited
ASQ	Agri-Science Queensland
CFI	Carbon Farming Initiative
CHP	Combined heat and power (biogas use system)
CH ₄	Methane
CO ₂	Carbon dioxide
CO ₂ -e	Equivalent carbon dioxide global warming impact
CPP	Closed position proving
DAFF	Australian Department of Agriculture, Fisheries and Forestry
DAFF (Qld)	Department of Agriculture, Fisheries and Forestry (Queensland)
DCCEE	Department of Climate Change and Energy Efficiency
FCI	Fluid Components International
GHG	Greenhouse gas
GWP	Global warming potential
H ₂ S	Hydrogen sulphide
HDPE	High density polyethylene
HRT	Hydraulic retention time
HWS	Hot water system
LPG	Liquid petroleum gas
PE	Polyethylene
PSH	High gas pressure switch
PSL	Low gas pressure switch

QNPB	Queensland Natural Pork Holdings
RDA	Rural Development Agency of Korea
RIRDC	Rural Industries Research and Development Corporation
SPU	Standard pig unit
T1	Timer
TS	Total solids
VS	Volatile solids
EC	Electrical conductivity
pH	Measure of the hydrogen ion concentration used to describe acidity / alkalinity of a substance

Contents

- Foreword..... iii**
- Acknowledgments..... iv**
- Abbreviations..... iv**
- Executive Summary x**
- Introduction 1**
 - Background..... 1
 - Piggery details..... 1
 - Biogas collection system details 3
- Objectives..... 5**
- Methodology 6**
 - Biogas extraction system upgrade 6
 - Stage 1 – Upgrade of biogas extraction system 7
 - Stage 2 – Installation of biogas reticulation pipeline and water heating system 8
 - Water heating control system operation..... 14
 - Operational data collection..... 14
 - Sampling 16
 - Pond influent sampling..... 16
 - Pond effluent sampling..... 17
 - Pond sludge sampling..... 19
 - Sample Analysis..... 20
 - Biogas quality monitoring..... 20
- Results 21**
 - Temperature data 21
 - Pond influent, effluent and sludge analysis results..... 23
 - Biogas composition monitoring..... 25
 - Extension of biogas technology 26
 - Formal presentations / conference papers..... 26
 - Site visits / field days 26
 - Media interviews..... 27
 - Television / video productions 27
- Implications..... 28**
 - GHG emission abatement 28

Piggery energy audit	28
Cogeneration unit feasibility assessment.....	31
Business case	33
System cost.....	33
Expected returns.....	33
Conclusions	36
Recommendations	38
References	39
Appendices	40
Appendix A – Biogas Field Day Fact Sheet.....	40
Appendix B – Safety Management Plan.....	3

Tables

Table 1.	Details of biogas extraction and use system components.	7
Table 2.	Manufacturer’s technical gas performance details for Rheem Model 631 265NO heavy duty gas hot water system which was converted to operate on biogas.....	8
Table 3.	Parameters monitored during the course of the project.....	15
Table 4.	Averages and ranges of ambient air, pond effluent and biogas temperatures.	21
Table 5.	Summaries of the total solids (TS), volatile solids (VS), pH and electrical conductivity (EC) analysis results determined at the Agri-Science Queensland (ASQ) laboratories for 6 sampling dates.....	23
Table 6.	Biogas analysis results obtained using the Geotech Biogas Check portable gas analyser.	25
Table 7.	Monthly estimates of piggery energy requirements and biogas generation based on average monthly temperature data for the Grantham site.	32

Figures

Figure 1.	QNPH ‘Palahra’ piggery location, near the town of Grantham, south-east Queensland.	2
Figure 2.	Aerial photograph of the piggery showing the locations of the partially covered primary effluent pond, biogas pipeline, water heating unit and biogas scrubber.	3
Figure 3.	Schematic drawing of the Stage 1 upgraded biogas extraction system and the Stage 2 biogas delivery pipeline and water heating system.	6
Figure 4.	Biogas extraction system installed adjacent to the north-western corner of the primary effluent pond.	8
Figure 5.	Biogas piping system used to convey biogas from the biogas extraction system to the water heating system.	10
Figure 6.	Schematic drawing of the electrical control system used to control the operation of the water heater.	11
Figure 7.	Water heating system and iron sponge scrubber installed between piggery sheds 2 and 3.	11
Figure 8.	Schematic drawing of hot water recirculation system used to heat farrowing sheds.....	12
Figure 9.	Typical copper pipe ‘S’ shaped section prior to pouring one of the concrete heating pads in the piggery farrowing sheds.....	13
Figure 10.	Farrowing pen at the Grantham piggery showing one of the concrete pads heated by circulating hot water through copper pipes cast into the pad.....	13
Figure 11.	Landis+Gyr model 750 gas meter fitted with Elster IN-Z61 low frequency pulse transmitter installed on biogas reticulation pipeline to measure water heater biogas usage.....	16

Figure 12. Davey D120GA submersible grinder pump installed in sump for collection of shed effluent samples.....	18
Figure 13. Tipping drum in position beside sump.....	18
Figure 14. Agitating tipping drum contents in preparation for sub-sampling.....	18
Figure 15. Tipping drum contents into sump after sub-sample collection.....	18
Figure 16. Sludge sampling near the northern end of the floating pond cover.....	19
Figure 17. Geotech Biogas Check portable gas analyser used to monitor biogas quality.....	20
Figure 18. Ambient air, pond effluent and biogas temperatures logged at 30 minute and 1 hour intervals from June 2011 to May 2012.....	22
Figure 19. Average monthly ambient air, pond effluent and biogas temperatures.....	22
Figure 20. Volatile solids / total solids ratios for pond inflow, pond outflow and sludge samples.....	24
Figure 21. Results of an energy audit carried out for the Grantham piggery for the 12-month period from April 2009 to March 2010.....	29
Figure 22. Draft DAFF Queensland Piggery biogas energy calculator printout for the Grantham piggery, based on April 2009 to March 2010 occupancy.....	30
Figure 23. Monthly estimates of piggery energy requirements and biogas generation based on average monthly temperature data for the Grantham site.....	32
Figure 24. Draft DAFF Queensland Piggery biogas energy calculator printout for the Grantham piggery, based on near full occupancy (1370 SPU) and the estimated average biogas production used in the cogeneration unit feasibility assessment.....	35

Executive Summary

What the report is about

This report describes the outcomes from the Australian Methane to Markets in Agriculture (AM2MA) research project PRJ-005672 ‘Methane recovery and use at a piggery – Grantham’. This project involved upgrading the biogas extraction system originally installed in conjunction with a partial floating cover, retro-fitted to the primary anaerobic pond at the QNPH Grantham piggery under an earlier AM2MA project (Project No. PRJ-003003), as described by Skerman *et al* (2011). Following the system upgrade, this project also included installing a biogas reticulation pipeline to supply biogas from the extraction system, to a water heating system used to heat water circulated through underfloor heating pads in the piggery farrowing sheds. This biogas fired water heating system has the potential to significantly reduce on-farm energy costs by replacing a significant proportion of the Liquid Petroleum Gas (LPG) previously used for farrowing shed heating. Further monitoring of the biogas system performance has also been carried out. This report describes the work undertaken and outlines the monitoring results, implications, conclusions and recommendations arising from this work.

Who is the report targeted at?

The information provided in this report will assist producers, industry bodies, researchers, industry service providers, contractors, government policy makers and regulators who have an interest in the planning, design, installation and operation of biogas capture and reuse systems at Australian intensive livestock production facilities.

Where are the relevant industries located in Australia?

The outcomes of this research are directly applicable to the Australian pork industry and could be adapted to other intensive livestock industries, particularly the dairy industry. The pork and dairy industries operate in all Australian states. There has been considerable interest in adopting biogas collection and use systems within the Australian pork industry during recent years. At the present time, several major Australian pig producers are in the process of investigating, planning or constructing on-farm biogas systems. The recent introduction of the Carbon Farming Initiative (CFI) ‘Methodology for the destruction of methane generated from manure in piggeries’ (DCCEE, 2011) has resulted in increased producer and industry interest in adopting on-farm biogas technology.

Background

This project followed on from two previous AM2MA projects carried out at the Queensland Natural Pork Holdings (QNPH) Grantham piggery, viz. Project No. PRJ-003003: ‘Biogas production by covered lagoons – QNPH piggery, Grantham Qld’; and PRJ-004547: ‘Options for biogas cleaning and use on-farm’. The final reports for these projects (Skerman *et al*, 2011 and 2012, respectively) provide detailed background information regarding the piggery operation, design and installation of the partial floating pond cover, operational monitoring data and details of the design and installation of the biogas scrubber.

During the course of Rural Industries Research and Development Corporation (RIRDC) Project No PRJ-003003, a review of the original biogas extraction system installed at the Grantham piggery site identified that certain components did not comply with the Queensland gas safety legislation. This most recent project included funding to upgrade the original biogas system to ensure compliance with the relevant legislation, in addition to installing a biogas reticulation pipeline and water heating system to enable the biogas energy to be utilised productively on-farm.

Aims/objectives

The objectives of this project, as outlined in the Research Agreement, were:

- to drive the uptake of waste water methane recovery and beneficial use technologies in Australian agriculture by demonstrating such technologies at a piggery
- to communicate the benefits of methane recovery and use as a clean energy source through reports and field days at the demonstration site
- to adapt technologies, quantify risks and collect data to facilitate improvement of economic assessment and emissions estimation through activities at the demonstration site
- to increase understanding of the benefits of recovering waste methane as a resource
- to reduce the uncertainty, risk and cost of installing methane recovery and use systems.

Methods used

This project was implemented as follows:

- The original biogas extraction system installed at the QNPH Grantham piggery was upgraded to ensure compliance with the relevant Queensland gas safety legislation and standards. This required preparation of a revised system design, schematic drawings and tender documents.
- Ongoing monitoring of biogas quality, pond influent and effluent characteristics, and pond effluent, biogas and air temperatures continued on from Project No. PRJ-003003. This monitoring data has been collated and analysed.
- A biogas reticulation pipeline was designed and installed to convey biogas from the extraction system beside the covered pond, to a biogas-fired water heating unit, situated between piggery sheds. A commercial water heater was converted to run on biogas and an electrical control system was designed and installed to automatically operate the biogas heating unit in conjunction with an existing LPG unit previously used as the sole source of farrowing shed heating.
- The feasibility of installing a cogeneration unit, producing both electrical power and heat, was examined, based on the available performance data and estimates of biogas production and heating / cooling energy requirements during a year experiencing average climatic conditions.
- A range of activities were carried out to communicate the benefits of methane recovery and use as a clean energy source. These activities included hosting site visits by various groups, organising an on-farm field day, preparing and presenting formal papers at a conference and symposium, giving informal talks to a range of visiting groups, doing media interviews, and participating in television / video productions.

Results/key findings

The temperature data collected during this project was consistent with data collected during PRJ-003003 (Skerman *et al*, 2011). The relatively high thermal mass of the effluent stored in the pond resulted in more stable pond effluent temperatures in comparison to the ambient air temperatures recorded at the site. This buffering effect appeared to increase with depth in the pond.

Analyses of the effluent discharged from the partially covered primary pond showed a 94% reduction in the average volatile solids (VS) concentration, in comparison to the pond influent. This result is consistent with data collected during PRJ-003003 (Skerman *et al*, 2011).

Biogas composition analyses suggested average methane, carbon dioxide and hydrogen sulphide concentrations of 69%, 30% and 2000 ppm, respectively. This average methane concentration is consistent with the value reported by Skerman *et al* (2011).

A preliminary assessment of the potential for installing a CHP system suggested that the installation of a CHP system may provide the producer with greater flexibility for utilising the available biogas energy. However, any economic benefit is likely to be marginal in comparison to using all of the available biogas for underfloor farrowing shed heating. A more definitive assessment will be possible when the additional operational monitoring data becomes available.

Implications for relevant stakeholders

Federal Government estimates at the time of the recent Carbon Farming Initiative (CFI) methodology launch indicated that there are approximately 690 piggeries in Australia which could potentially implement biogas collection and flaring/use systems. Without the implementation of abatement measures, annual piggery emissions are expected to be 1.3 Mt CO₂-e by 2020. It is estimated that an emission abatement of around 50% of this figure could be achieved through the installation of biogas collection and flaring/use systems, in accordance with the CFI methodology.

In systems where the biogas is used as an energy source for shed heating and/or electrical power generation, further reductions in greenhouse gas (GHG) emissions will result, along with savings in energy costs.

This level of uptake by industry will not be achieved unless producers have confidence in the available technology and likely economic returns. The outcomes of this project will contribute to a reduction in risk associated with the adoption of the CFI methodology, particularly for smaller scale producers who may not be able to afford to employ specialist consultants and contractors to carry out the required design and installation.

In addition to GHG abatement, if Australian intensive livestock producers are going to benefit from the significant energy resources and resulting cost savings available from the collection of biogas, they will need practical guidance on the selection and use of technologies to enable effective use of the biogas. These technologies must be robust, cost effective, and relatively simple to operate with minimal labour. The technologies developed and evaluated in this project were selected to meet these criteria.

It is anticipated that the costs incurred in establishing the biogas system at the Grantham piggery could be recouped over an 8 year payback period, based on estimated reductions in LPG heating costs and revenue from carbon credits. This simple analysis has not considered ongoing operation and maintenance costs, depreciation and interest repayments. The payback period may have been reduced to approximately 6 years if the original biogas extraction system had been designed and installed to the required standards, negating the need for the system upgrade.

It is anticipated that pig producers will be able to establish new biogas collection and use systems at lower costs than those incurred at the Grantham piggery, for a range of reasons outlined in the report.

Recommendations

An addendum to this Final Report (or a revised Final Report) should be prepared following the conclusion of the extended monitoring period. This will be available from the RIRDC web site.

Because it was not feasible to install a CHP cogeneration system at the Grantham piggery, it is recommended that further case studies be carried out at piggeries where CHP systems have been either recently installed, or are about to be installed in the near future. Operational data and experience gained from these piggeries will assist other producers interested in installing similar

systems. These case studies should be carried out at piggeries of various sizes, at different climatic locations which are representative of conditions experienced at a large proportion of the Australian pig industry.

Introduction

Background

Methane is the dominant greenhouse gas emission from Australian agriculture and has been identified as a priority area for emission reductions within the livestock sector. The potential for capture and use of methane is greatest in the intensive livestock industries, where manure management is estimated to contribute three percent of the emissions from Australian agriculture.

Recent life cycle assessment studies (Wiedemann *et al*, 2010) suggest that the main sources of global warming potential (GWP) in producing pork result from the production of feed upstream of the piggery and the management of piggery effluent. In conventional housing piggeries, this was particularly noticeable, with 66% of the overall GWP coming from the piggery ponds. However, this emission source can be controlled through various technologies such as pond covering and flaring to burn methane, which may reduce overall emissions by up to 50% across the supply chain.

The recent launch of the Carbon Farming Initiative (CFI) *Methodology for the destruction of methane generated from manure in piggeries* (DCCEE, 2011) could provide pig producers with a new source of revenue for undertaking projects that capture and burn methane emitted from anaerobic ponds. Under this methodology, the methane can be either flared or utilised for productive heating or power generation purposes, effectively converting the methane to carbon dioxide which has a significantly lower GWP. This will enable producers to generate carbon credits which can be sold in emerging carbon markets.

This project, which was funded by the Australian Methane to Markets in Agriculture (AM2MA) program, was carried out at the Queensland Natural Pork Holdings (QNPH) Grantham piggery. A partial floating cover was retrofitted to an existing anaerobic effluent pond at this piggery under an earlier AM2MA project (Project No. PRJ-003003 Biogas production by covered lagoons – QNPH piggery, Grantham Queensland). Details of the piggery operation, cover design, installation and performance data are provided in the Final Report prepared for this project by Skerman *et al* (2011).

During the previous project, a review of the original biogas extraction system installed at the Grantham piggery identified that certain components did not comply with the Queensland gas safety legislation. This project included funding to upgrade the original biogas extraction system to ensure compliance with the relevant legislation, in addition to installing a biogas reticulation pipeline and water heating system to enable the biogas energy to be utilised productively on-farm. The piggery farrowing sheds are now heated by circulating hot water through underfloor heating pads installed in the farrowing pens. The water is heated by a commercial hot water system which was converted to run on biogas. The biogas fired water heater was integrated into an existing Liquid Petroleum Gas (LPG) fired water heating system installed previously at the piggery. The new system has the potential to significantly reduce on-farm energy costs by using the biogas to supplement/replace LPG consumption.

Piggery details

The Queensland Natural Pork Holdings (QNPH) ‘Palahra’ piggery is situated approximately 1.2 km south-west of the town of Grantham in the Lockyer Valley, south-east Queensland, as shown in Figure 1. The town of Grantham is approximately 100 km west of Brisbane.

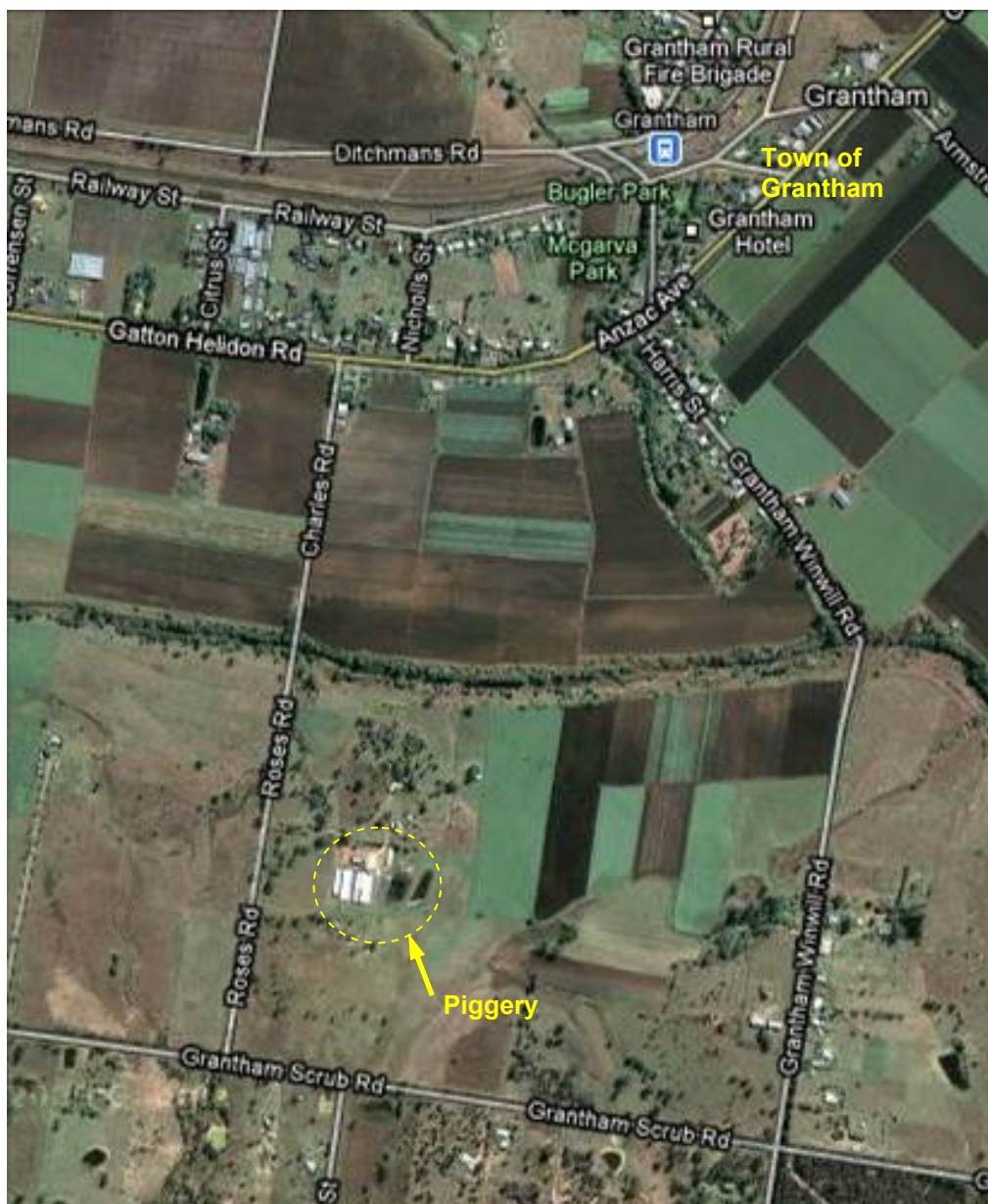

Figure 1. QNPH 'Palahra' piggery location, near the town of Grantham, south-east Queensland.

The piggery operates as a specialised breeder unit, housing 700 sows. Weaned piglets are transported off-site, to contract grower units, at three to four weeks of age. The resulting 1600 pigs (1400 standard pig units - SPU) at the site are housed in two dry (gestating) sow sheds and two farrowing sheds with partially slatted floors. The pig manure and hosing water is collected in static pits, located under the shed floors. Effluent is released weekly from the static pits and is conveyed into a primary anaerobic treatment pond, via a 300 mm diameter gravity pipeline. The primary pond overflows by a gravity pipeline into a secondary pond.

The primary and secondary ponds have capacities of 1.7 and 1.5 ML, respectively, resulting in a primary pond volatile solids (VS) loading rate of approximately $0.2 \text{ kg VS} \cdot \text{m}^{-3} \cdot \text{day}^{-1}$, with a hydraulic retention time (HRT) of approximately 130 days. An aerial photograph of the piggery is provided in Figure 2.

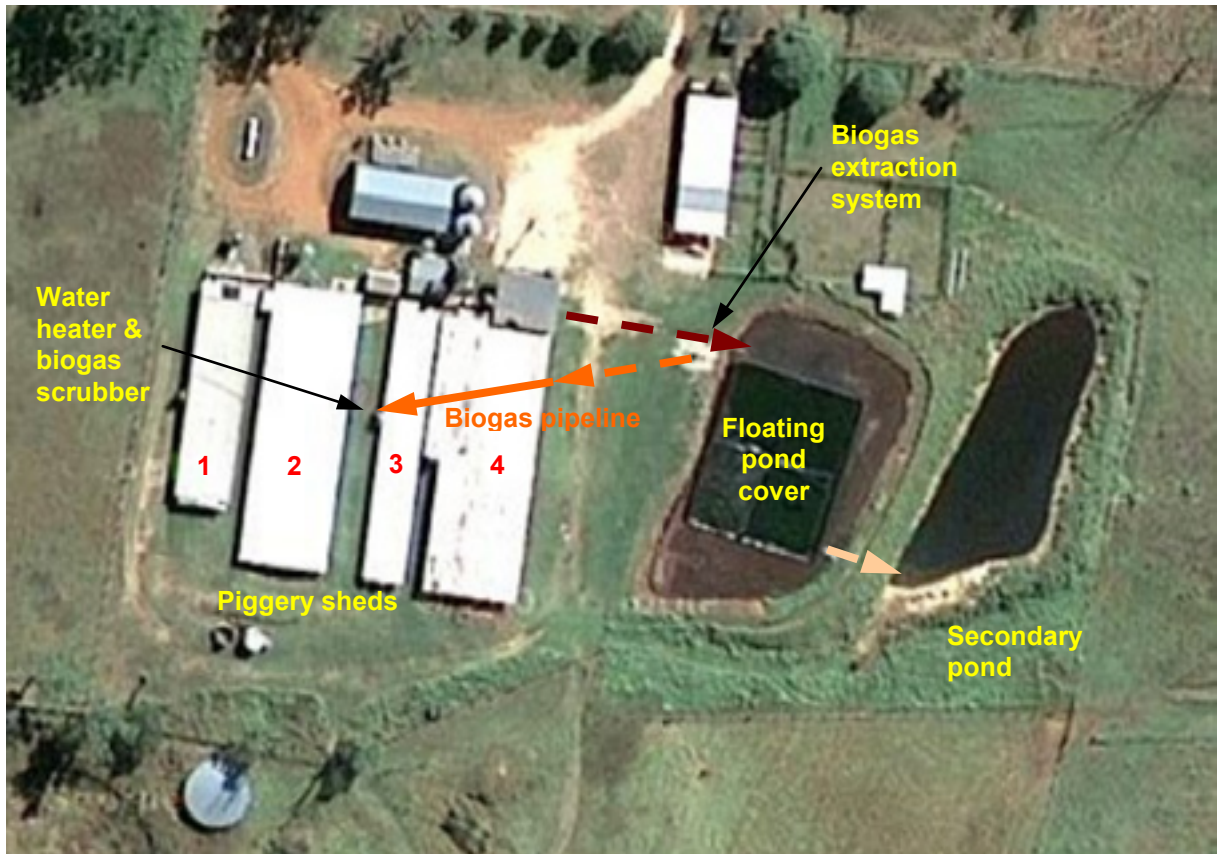

Figure 2. Aerial photograph of the piggery showing the locations of the partially covered primary effluent pond, biogas pipeline, water heating unit and biogas scrubber.

Biogas collection system details

For RIRDC Project PRJ-0003003, the AM2MA Steering Committee decided to trial the use of a partial floating cover at the Grantham site as they felt that it may provide a convenient retro-fit option for installation on existing effluent ponds at intensive livestock production facilities. Furthermore, other sites included in the AM2MA program (e.g. Bear's Lagoon piggery) were already employing a full pond cover secured by trenching into the embankment. Deployment of a partial floating cover at the Grantham piggery enabled the evaluation of a potentially viable alternate option.

The AM2MA Steering Committee selected a Dunedin (New Zealand) based company, Waste Solutions, to design and install the partial floating cover and associated biogas extraction system at the QNPH Grantham piggery. Waste Solutions employed a subsidiary company, Total Constructions Limited (TCL) to carry out the on-site fabrication and installation of the floating cover. The floating pond cover was fabricated on-site over a period of approximately one week, prior to launching on 20 February 2009. Installation of the original biogas extraction and monitoring equipment was completed on 25 February 2009.

As shown in the aerial photograph (Figure 2), the floating cover is rectangular in shape, having dimensions of approximately 30 m x 25 m, covering approximately half of the pond surface area. The cover was fabricated on the relatively flat, grassy area between the primary effluent pond and the piggery sheds.

Skerman *et al* (2011) reported an average biogas yield from the covered pond of 65 m³/day (corrected to 15°C and 101.3 kPa), with an average methane concentration of 73%, resulting in an average methane yield of 47.5 m³/day (32.2 kg CH₄/day). This is equivalent to an average daily methane yield per mass of VS entering the pond of 0.15 m³ CH₄/kg VS or 0.10 kg CH₄/kg VS.

Skerman *et al* (2011) estimated that the average biogas yield could produce 1606 MJ/day of primary (heat) energy. This energy could be used to offset the LPG currently used to heat water circulated through concrete heating pads in the farrowing pens, resulting in a potential saving of \$23,000 per year.

Objectives

The following objectives were specified in the Research Agreement:

- drive the uptake of waste water methane recovery and beneficial use technologies in Australian agriculture by demonstrating such technologies at a piggery
- communicate the benefits of methane recovery and use as a clean energy source through reports and field days at the demonstration site
- adapt technologies, quantify risks and collect data to facilitate improvement of economic assessment and emissions estimation through activities at the demonstration site
- increase understanding of the benefits of recovering waste methane as a resource
- reduce the uncertainty, risk and cost of installing methane recovery and use systems.

Methodology

Biogas extraction system upgrade

During the course of RIRDC Project No PRJ-003003, it was identified that certain components of the original biogas extraction system (between the pond cover and the flare) installed at the Grantham piggery site by Waste Solutions Ltd, did not comply with the Queensland gas safety legislation, viz. the *Petroleum and Gas (Production and Safety) Act and Regulation, 2004*. Furthermore, it appeared that the installation was not carried out in accordance with the legislation and no certificates of compliance or approval were issued.

A review of the installed system was carried out by a type B gas approval authority (Hyde Combustion Pty Ltd) in December 2009. This review identified areas of non-compliance requiring rectification. One of the main areas of non-compliance in the original system involved the use of polyethylene (PE) and poly vinyl chloride (PVC) pipe work and valves. The report by Hyde Combustion Pty Ltd indicated that the use of plastic piping is prohibited above ground, in accordance with *AS 5601 Table 3.1 - Consumer Piping Materials and Duty Limits*; and that while high density polyethylene (HDPE) is acceptable for the pond membrane (cover), gas collection system and semi-flexible connection to the edge of the pond, all other above ground pipe work, fittings and valves must be installed in stainless steel. The main concern was fire damage, from a grass fire or flame front inside the pipe, back to the face of the flash back (flame) arrestor.

In consultation with Hyde Combustion, a new design was produced to upgrade the existing biogas extraction system (Stage 1), and to install a biogas reticulation pipeline and water heating system (Stage 2), in accordance with the relevant State legislation. A schematic drawing of the Stage 1 and 2 system design is provided in Figure 3. The various system components are described in Table 1.

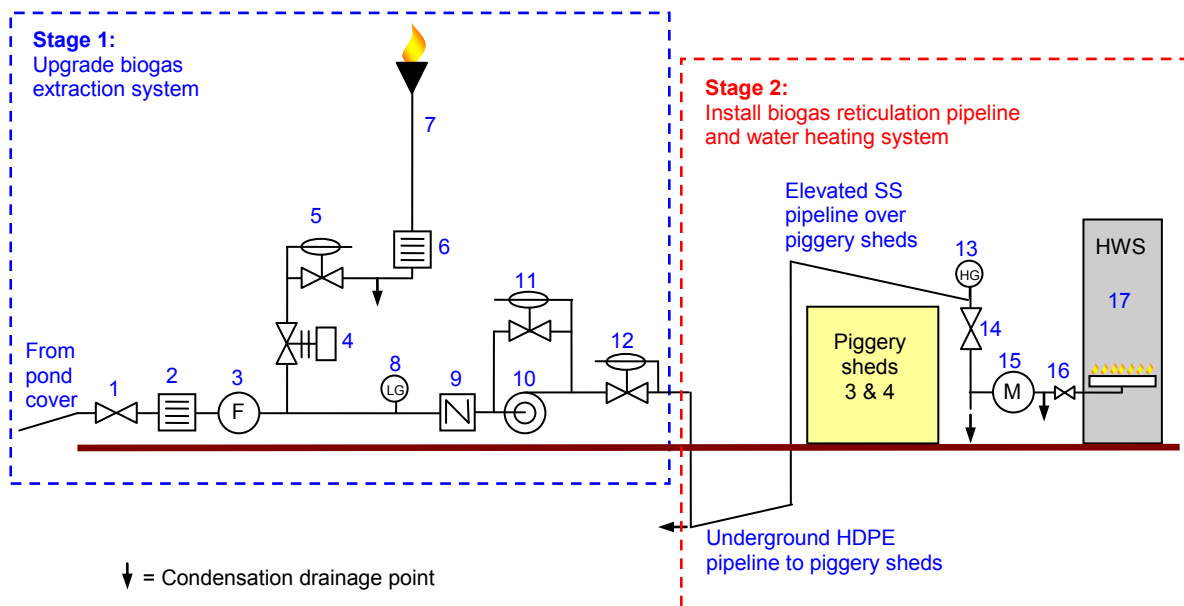

Figure 3. Schematic drawing of the Stage 1 upgraded biogas extraction system and the Stage 2 biogas delivery pipeline and water heating system.

Table 1. Details of biogas extraction and use system components.

Item No	Item description	Manufacturer	Type
1	Isolating valve		
2	Flame arrester	Groth Corporation	Model No: 7628-02-55-F00
3	Filter		
4	N/O (normally open) pneumatically actuated valve	Norbro	40R
5	Forward feed relief regulator		
6	Flame arrester	Landfill Service Corporation	Inline stainless steel wire-gauze - built into flare
7	Flare	Landfill Service Corporation	Solar Spark Vent Flare CF-5
8	Low gas pressure switch	Beta	Vacuum pressure switch W8-V304-S1N-P5-N1
9	Non return valve		
10	Gas pressure booster	Secomak	Model 576
11	Forward feed relief regulator		
12	Forward feed relief regulator		
13	High gas pressure switch		
14	Isolating valve		
15	Gas flow meter	Landis+Gyr	Model 750 with elster IN-Z61 pulse output
16	Isolating valve		
17	Hot water system	Rheem	Model 631265NO

Stage 1 – Upgrade of biogas extraction system

In May 2010, a quotation was provided by an authorised type B gas installer (Williamson Brothers, Toowoomba) for the Stage 1 upgrade (\$58,056 incl. GST). Funding for both Stages 1 and 2 were included in the budget for this project (No PRJ-005672) based on the original quotation received from Williamson Brothers for the Stage 1 work and estimates for the cost of the Stage 2 work and related electrical work. The project agreement with RIRDC was signed on 20 August 2010.

‘Request for Offer’ documentation was prepared to facilitate a competitive tender process to proceed. (The author can supply a copy of this document on request). Tenders for the Stage 1 upgrade closed in October 2010. The only offer received for the upgrade was submitted by a Brisbane based company. This offer was three times more than the original quotation and project budget. Due to authorisation issues resulting from a change in business ownership, Williamson Brothers (who submitted the original quotation) did not submit an offer for this tender. Following resolution of the authorisation issues, Williamson Brothers submitted a revised offer (\$56,650 incl. GST) in February 2011 which was formally accepted in March 2011. (The original quotation included the supply and installation of a new gas meter whereas the tender did not include this item.)

Following significant delays in the delivery of several system components from overseas suppliers, the upgraded biogas extraction system (Stage 1) was eventually re-installed during November 2011. Figure 4 is a photograph showing the upgraded system installed near the north-western corner of the partially covered effluent pond.



Figure 4. Biogas extraction system installed adjacent to the north-western corner of the primary effluent pond.

Stage 2 – Installation of biogas reticulation pipeline and water heating system

Stage 2 involved installing underground HDPE pipeline from the biogas extraction system to the eastern side of shed four, and elevated stainless steel pipeline over the rooves of sheds three and four to reticulate biogas from the extraction system to a water heating unit, installed between sheds two and three. Figure 5 is a schematic drawing showing the biogas reticulation pipeline. Quotations for this work were requested from several South-East Queensland gas installation companies. Only one quotation was received from Williamson Brothers (Toowoomba) for a sum of \$45,364 (incl. GST). Following delays in the supply of stainless steel pipe and fittings, the Stage 2 biogas pipeline installation was completed in March 2012.

A new Rheem Model 631265NO heavy duty gas hot water system (HWS) designed to run on natural gas, was installed between piggery sheds two and three, beside a similar, existing LPG fired unit, during April 2012. The manufacturer’s performance details for this HWS are provided in Table 2.

Table 2. Manufacturer’s technical gas performance details for Rheem Model 631 265NO heavy duty gas hot water system which was converted to operate on biogas.

Gas Type:	Units	Nat/SNG	Propane	Butane
Thermal Input	MJ/h	110	100	95
Output	kW	23.8	21.7	20.6
Min. Gas Supply Pressure	kPa	1.13	2.75	2.75
Test Point Pressure	kPa	0.85	2.50	2.50
Max. Gas Supply Pressure	kPa	3.5	3.5	3.5

During April 2012, an electrical control system, as outlined in Figure 6, was installed by a licensed electrician to control the water heating system operation. The cost associated with the supply and installation of the electrical control system was approximately \$5000 (incl. GST).

Following the pipeline connection and electrical control system installation, the HWS was converted to run on biogas by Williamson Brothers gas fitters. This involved adjusting the burner pressure at the inlet regulator, drilling out the main jet from 4.8 mm to 6.0 mm and making minor adjustments to the mixture (interrupter) screw on the burner throat. An exhaust gas analyser was used to assess the combustion efficiency of the converted HWS burner. Following the installation of the electrical control system, the heating system was commissioned in April 2012.

In Queensland, the offer for sale, installation or use of Type A (domestic) and Type B (industrial) gas devices can only occur if the device has been approved by the Chief Inspector or by a person or body approved by the Chief Inspector under s733(2) of the *Petroleum and Gas (Production and Safety) Act 2004*. The converted biogas HWS received Australian Gas Association (AGA) certification and a certificate of conformity was issued on the 22nd of October 2012 as required under the legislation.

Figure 7 is a photograph showing the water heating system and iron sponge scrubber developed to remove hydrogen sulphide from the biogas. The development of the scrubber is described in detail in the Final Report for PRJ-004547 (Skerman *et al*, 2012).

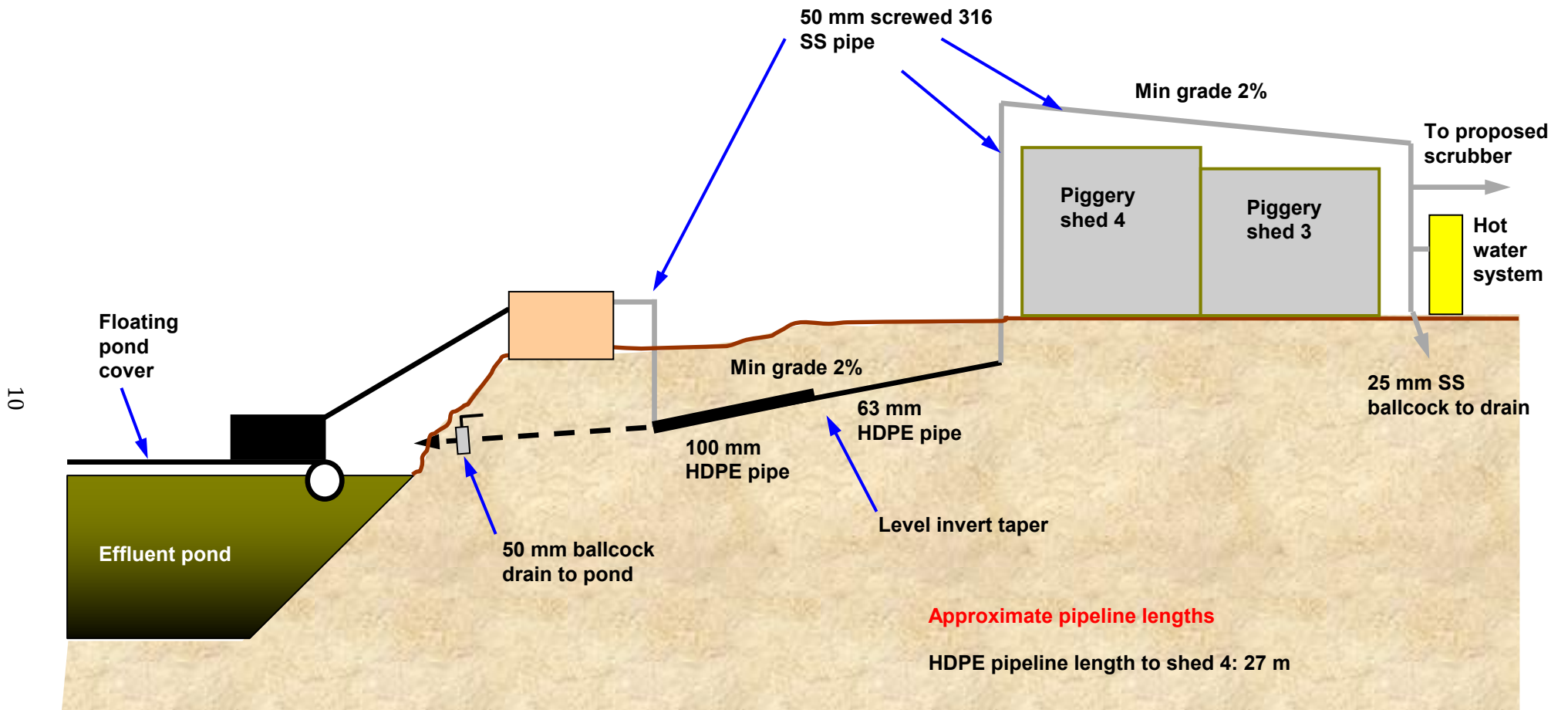

Figure 5. Biogas piping system used to convey biogas from the biogas extraction system to the water heating system.

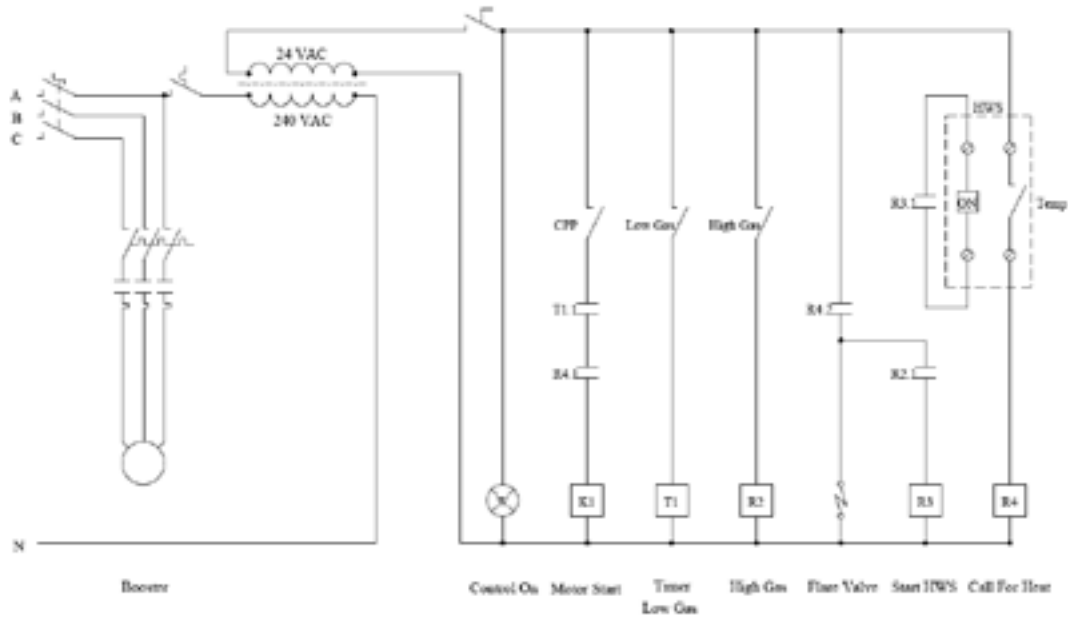

Figure 6. Schematic drawing of the electrical control system used to control the operation of the water heater.

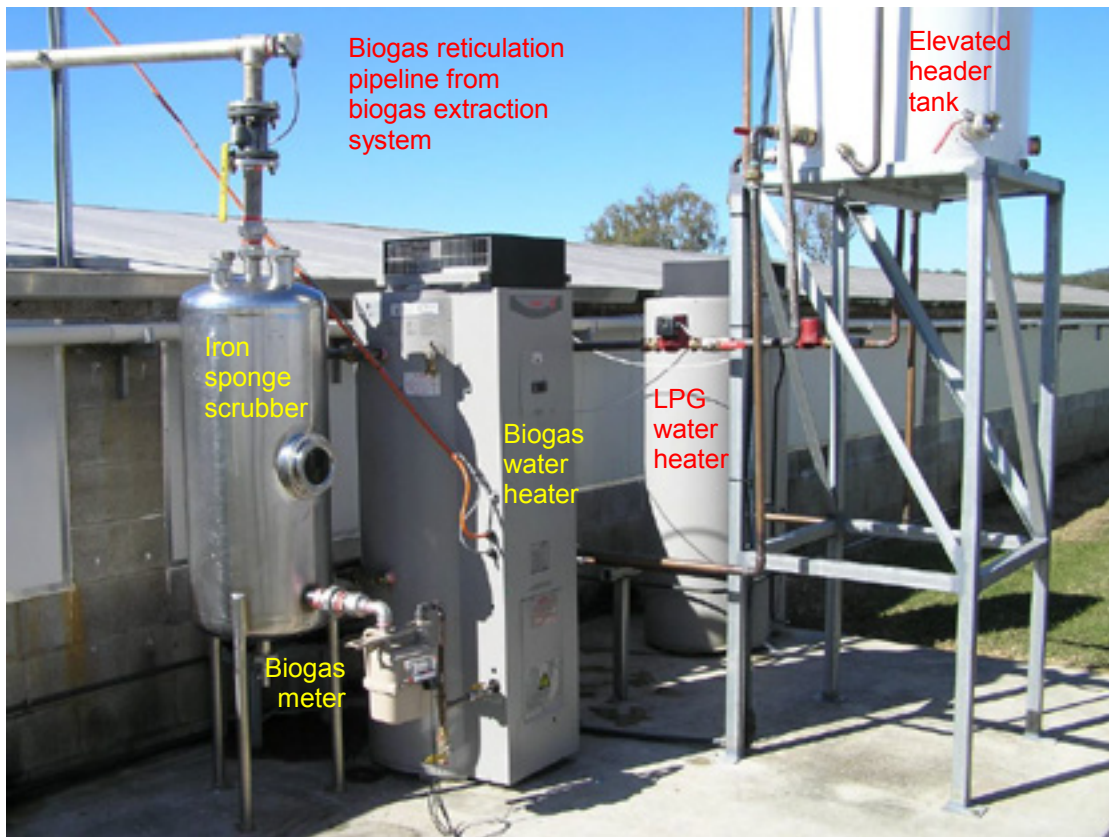

Figure 7. Water heating system and iron sponge scrubber installed between piggery sheds 2 and 3.

As described in the Final Report for PRJ-004547 (Skerman *et al*, 2012), hot water from the biogas HWS and the adjacent HWS supplied by LPG is circulated through an elevated, insulated header tank as shown in the schematic drawing provided in Figure 8. An additional circulation pump circulates hot water from the header tank through concrete heating pads cast into the floors of the farrowing pens in piggery sheds one and three. This form of underfloor heating provides comfort and optimal growing conditions for the piglets housed in these sheds.

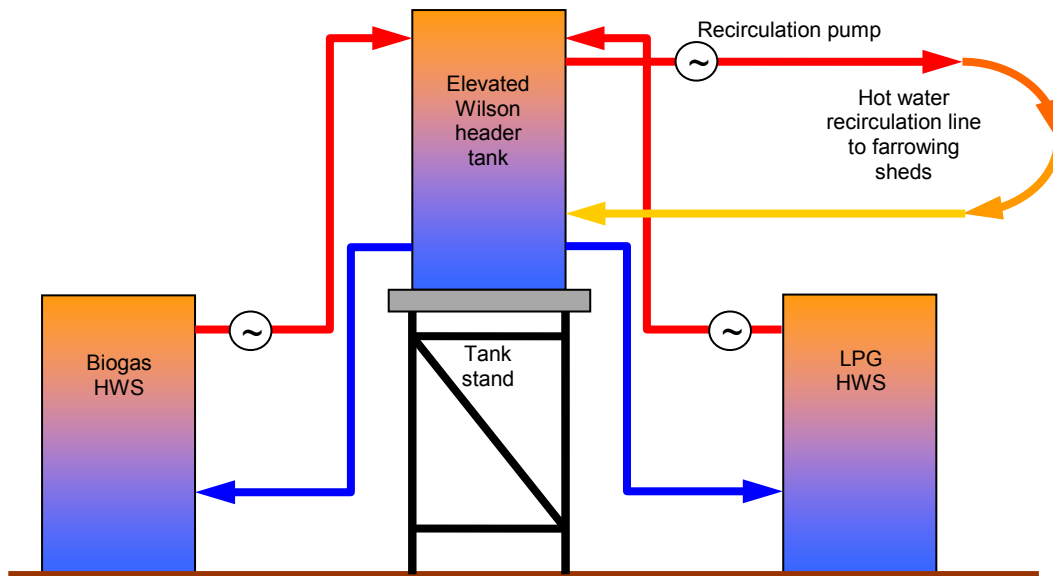

Figure 8. Schematic drawing of hot water recirculation system used to heat farrowing sheds.

The underfloor heating system in the farrowing sheds was installed by the piggery owners during 2010. Diameter 15 mm copper pipe was bent into an ‘S’ shape ready for installation in concrete heating pads cast into the floors of each farrowing pen, as shown in Figure 9.

The concrete pads were formed by removing some of the plastic tiles and installing a plywood base. The copper pipe ‘S’ sections are joined (in series) using flexible polybutylene hot water pipe and fittings (Hepworth Hep₂O). Hot water is circulated from the elevated hot water header tank through approximately 30 under-floor heating pads per circulation line.

The heating pad temperature was regulated to achieve a target pad temperature of 32 - 34°C by adjusting a valve on each recirculation line. The thermostats on the hot water systems are set at 60 - 65°C. During the system commissioning stage, the pad temperatures were monitored using an infrared thermometer.

A photograph of an operating heating pad in a farrowing pen is provided in Figure 10.



Figure 9. Typical copper pipe 'S' shaped section prior to pouring one of the concrete heating pads in the piggery farrowing sheds.



Figure 10. Farrowing pen at the Grantham piggery showing one of the concrete pads heated by circulating hot water through copper pipes cast into the pad.

Water heating control system operation

The water heating control system is designed to operate as follows (refer to Figure 3 and Table 1 for system component identification):

- Hot water system (HWS - 17) calls for heat. (Signal out to master control.)
- The normally open (N/O) spring return air actuated valve (4) closes, isolating the flare (7) and the closed position proving (CPP) limit switch (refer to electrical schematic – Fig 2) makes.
- Provided the CPP and the low gas pressure switch (PSL - 8) are both made, the booster (10) will start.
- The booster (10) outlet pressure is controlled by the forward feed relief regulator (11).
- The reticulation pipeline pressure is controlled by the supply regulator (12).
- Provided the high gas pressure switch (PSH - 13) proves there is adequate gas pressure in the supply to the HWS (17), the HWS (17) will be enabled and will fire up.
- When the water heater (17) reaches the temperature set on the thermostat and no longer calls for heat, the signal will be lost and the master control (CPP) will shut down the system, and the flare isolation valve (4) will open.
- As pressure builds in the system the flare forward feed relief regulator (5) will allow gas to pass to the flare maintaining some pressure in the system.
- When the booster (10) is running, if the inlet gas pressure drops to less than 0.1 mbar (0.010 kPa) as measured at the PSL (8), the switch will open and the booster (10) will stop, preventing air being sucked into the system.
- As pressure in the outlet system drops, the PSH (13) will turn off the HWS (17) before all gas pressure in the reticulation line is lost. The gas reticulation pipe work will act as a buffer, providing some line pack¹.

The purpose of timer (T1) is to provide a delay for the booster operation. If the supply pressure drops below the pressure switch set point the booster will stop, protecting the supply. The inlet pressure will in all probability immediately bounce back up and restart the booster. In effect the booster will hunt (stop and start) and possibly burn out the motor. The timer will provide a delayed booster start to allow the pond to regenerate gas and the system to run for some time. The timer final setting will depend upon the load applied to the system relative to the gas generated and will need to be field adjusted to suit. It is expected that the timer setting may be in a range from 10 to 60 minutes.

Operational data collection

The Grantham piggery received record rainfall during December 2010 and January 2011, totalling approximately 800 mm and the Grantham township was devastated by flash flooding on 10 January 2010. While the piggery was not directly affected by the flooding, road access and electricity supply

¹ line pack (In pak) (engineering) The actual amount of gas in a pipeline or distribution system.

were cut for several days. This extreme weather event in conjunction with delays in the installation of the upgraded biogas system hampered normal data collection. Several of the data loggers required replacement due to water damage. Most data collection resumed by June 2011.

Table 3 describes the parameters monitored, locations, monitoring methods and data collection periods, for the operational data collected during the course of the project. This monitoring followed on from the data collection carried out under PRJ-003003, as reported by Skerman *et al* (2011).

Table 3. Parameters monitored during the course of the project.

Parameter	Location	Monitoring method	Data collection period
Pond effluent temperature	Edge of the floating cover at depths of 0.3, 1.0 and 1.8 m	HOBO Pendant temperature data loggers suspended from the floating cover using a stainless steel cable	June 2011 – May 2012
Ambient air temperature	Beside covered pond	Tinytalk temperature data logger and HOBO Pendant temperature data logger installed in solar radiation shield	June 2011 – May 2012
Biogas temperature	Biogas collection box on NW corner of floating pond cover	Tinytalk temperature data logger	June 2011 – May 2012
Biogas volume consumed in water heater	Adjacent to the water heater, between piggery sheds 2 and 3.	Landis+Gyr Model 750 gas meter fitted with an Elster IN-Z61 low frequency pulse transmitter and a HOBO Pendant event logger	May 2012 -

The Mace AgriFlo flow meter installed on the pond influent pipeline during PRJ-003003 was found to be unsuitable for recording shed effluent inflows. Consequently, no effluent inflow data was collected during this project.

A Roots Model G40 rotary displacement gas flow meter was installed by Waste Solutions during PRJ-003003, as part of the original biogas extraction system. This meter ceased functioning reliably in December 2009 and was sent away to the Australian service agent in March 2010 for servicing. Following reinstallation, it became apparent that this meter was not suitable for providing accurate and reliable gas production data at the relatively low passive pressures (unassisted by a mechanical gas pressure booster) which existed between the pond cover and flare. The original gas extraction system (including the Roots meter) was removed from the site during May 2011.

The updated system (Stage 1) which was installed in November 2011, did not include a meter to record gas flow through the flare. Subsequent enquiries suggested that a Fluid Components International (FCI) Thermal Dispersion Flowmeter (Model ST75V-2F1GN10JT0) may be suitable in this application. A quotation for this meter suggested a cost in excess of \$6000. There were insufficient funds available in the project budget to purchase and install a meter of this type.

The biogas water heating system (Stage 2) included the installation of a Landis+Gyr Model 750 domestic-style gas meter as shown in Figure 11. This meter is fitted with an Elster IN-Z61 low frequency pulse transmitter to enable logging of the hot water heater operation. This meter appears to operate reliably at the 3.5 kPa pressure provided in the biogas reticulation pipeline by the Secomak blower. A HOBO Pendant event logger was fitted to the pulse transmitter to record biogas usage. It is planned to install a similar logger on the LPG water heating unit to assist in monitoring and comparing both biogas and LPG usage for farrowing shed heating.

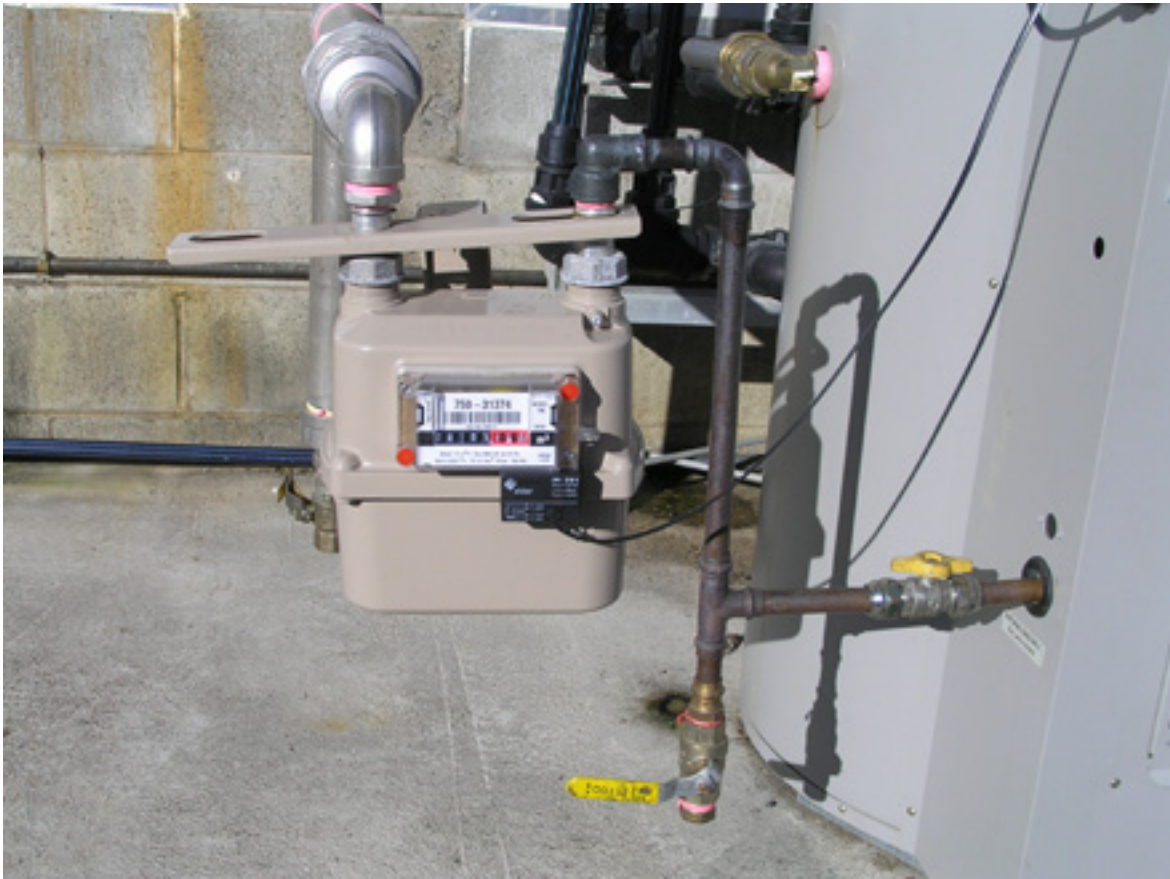

Figure 11. Landis+Gyr model 750 gas meter fitted with Elster IN-Z61 low frequency pulse transmitter installed on biogas reticulation pipeline to measure water heater biogas usage.

The delays experienced in upgrading the biogas extraction system (stage 1) and installing the biogas pipeline and water heater (stage 2) prevented the collection of any significant amount of heating system performance data prior to the June 2012 reporting deadline.

It is anticipated that RIRDC will approve an extension of this project for a further 12 month period to enable the collection of scrubber and water heating performance data. It is anticipated that an addendum to this report will be completed following the conclusion of the extended monitoring period, in June 2013. This will be available from the RIRDC website.

Sampling

Similar sampling practices were employed during this project as those described by Skerman *et al* (2011) for PRJ-003003. Descriptions of these methodologies have been reproduced in this report.

Pond influent sampling

Piggery shed effluent is released from the static pits underlying the four piggery sheds at approximately weekly intervals. The raw effluent from the sheds is conveyed to the partially covered anaerobic pond via a 300 mm diameter gravity pipeline. Samples of the shed effluent were collected on six occasions over the duration of the project. To ensure that the samples were representative of the entire effluent release from the four sheds, the following sampling procedure was used:

A Davey D120GA submersible grinder pump was installed in a sump located at the northern end of shed 4, on the upstream end of the gravity pipeline delivering effluent to the pond (Figure 12). As effluent was released from each of the sheds, the pump was run continuously, pumping effluent into a specially designed tipping drum, having a capacity of 200 L (Figure 13). As soon as the tipping drum filled with effluent, the contents were manually agitated using a plastic bladed canoe paddle (Figure 14). While the drum contents were being agitated, a sub-sample, generally having a volume of approximately 2 L, was collected from a 38 mm tap fitted approximately half way up the side of the 200 L tipping drum. The 2 L subsamples were poured into a 25 L drum.

The 200 L plastic drum was mounted in a steel tipping frame specially manufactured in the Agri-Science Queensland Toowoomba workshop, to enable the drum contents to be emptied quickly, with minimal physical effort. Following collection of each 2 L sub-sample, the contents of the 200 L tipping drum were tipped into the effluent sump, as shown in Figure 15. After the tipping drum was locked into the upright position, pumping into the tipping drum was recommenced as soon as possible. This procedure minimised disruption of the almost continuous sampling process which was designed to produce a representative composite effluent sample, with a manageable volume suitable for further sub-sampling and transport to the laboratory for analysis.

Pumping into the 200 L tipping drum was discontinued when there was insufficient effluent flow from the sheds to prevent the submersible pump from sucking air. By this time, the 25 L plastic drum was generally approximately 75% full. The contents of this drum were then agitated manually while a sub-sample was collected from a tap in the side of the drum, into a 1 L capacity wide-mouthed plastic sampling bottle. This sample was then placed on ice in a cooler for transport by car to the the Agri-Science Queensland laboratory in Toowoomba.

Pond effluent sampling

Following the release of the shed effluent and collection of the pond influent samples, samples of the effluent overflowing from the partially covered anaerobic pond were collected. These samples were collected from a length of lay-flat pipe attached to the end of the primary anaerobic pond overflow pipeline, at the point where it normally discharges into the secondary pond.

Similarly to the pond influent samples, the pond effluent sample was collected in a 1 L wide-mouthed plastic sampling bottle, before being placed on ice for transport to the Agri-Science Queensland laboratory in Toowoomba.



Figure 12. Davey D120GA submersible grinder pump installed in sump for collection of shed effluent samples.



Figure 13. Tipping drum in position beside sump.



Figure 14. Agitating tipping drum contents in preparation for sub-sampling.



Figure 15. Tipping drum contents into sump after sub-sample collection.

Pond sludge sampling

Samples of the sludge accumulating on the base of the partially covered anaerobic pond were collected near the northern end of the pond cover, on six occasions over the duration of the project. The sampling procedure involved positioning an aluminium boat at the sampling site, near the northern end of the pond cover, before collecting the samples from the base of the pond, using a sludge sampling pole. The pond is approximately 2 m deep at this point.

The pole was fabricated by Agri-Science Queensland from 2 lengths of PVC pipe having different diameters, so that the inner pipe fitted neatly inside the outer pipe. 200 mm long x 32 mm wide slots were cut in the lower ends of both pipes and caps were fitted on both ends. On the upper end of the pole, handles were fitted to both the inner and outer pipes so that they could rotate.

The samples were collected by rotating the handles to close the slot on the lower end of the sampler before inserting the sampling pole into the sludge on the base of the pond, as shown in Figure 16. The handles were then rotated to open the slot, allowing the sludge to flow into the inner pipe. The handles were then rotated once again to close the slot before withdrawing the pole from the pond and emptying the contents into a sampling bucket. This process was generally repeated a few times to collect the required sample volume. The contents of the bucket were then agitated manually and sub-sampled to provide a 1 L sub-sample.

Similarly to the pond influent and effluent samples, the sludge sample was placed on ice for transport to the Agri-Science Queensland laboratory in Toowoomba.



Figure 16. Sludge sampling near the northern end of the floating pond cover.

Sample Analysis

The following analyses were performed on the samples transported to the Agri-Science Queensland laboratory in Toowoomba:

- Pond influent, effluent and sludge samples:
Total solids (TS), Volatile solids (VS), pH and electrical conductivity (EC).

Biogas quality monitoring

A Geotech Biogas Check portable gas analyser, as shown in Figure 17, was purchased in June 2011, to enable convenient, regular monitoring of the biogas quality. The portable analyser measures methane and carbon dioxide by infra-red absorption, oxygen by an electrochemical cell and hydrogen sulphide by an electrochemical cell installed in an external gas pod. This instrument can be used to measure gaseous concentrations at any of the several tapping points installed along the biogas train.

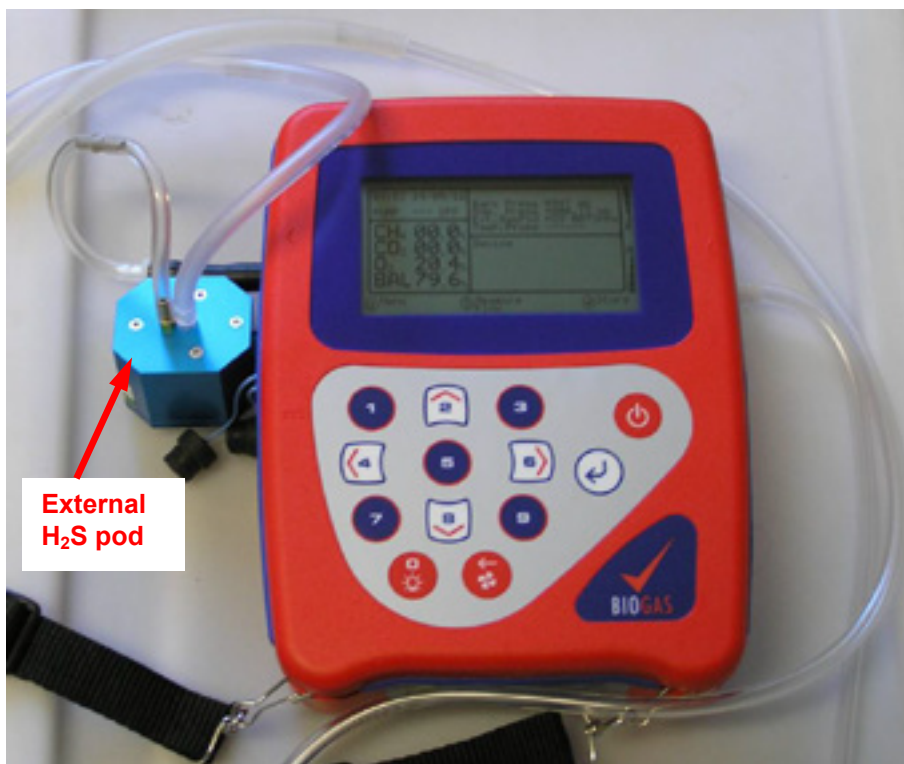

Figure 17. Geotech Biogas Check portable gas analyser used to monitor biogas quality.

Results

Temperature data

Table 4 provides a summary of the averages and ranges of the ambient air, pond effluent and biogas temperatures recorded at the site.

Table 4. Averages and ranges of ambient air, pond effluent and biogas temperatures.

Parameter	Ambient air	Pond effluent depth			Biogas
		0.3 m	1.0 m	1.8 m	
Monitoring period start	Jun 11	Jun 11	Jun 11	Jun 11	Jul 11
Monitoring period end	May 12	May 12	Mar 12	May 12	Mar 12
Logging interval (min)	30 / 60	30	30	30	30
Average temperature (°C)	18.5	22.1	22.3	22.2	26.6
Maximum temperature (°C)	38.8	32.0	28.8	28.8	66.2
Minimum temperature (°C)	-0.7	13.1	14.5	14.4	3.2
Temperature range (°C)	41.4	18.9	14.2	14.3	63.0

Figure 18 shows the variation in the pond effluent temperatures at depths of 0.3, 1.0 and 1.8 m (logged at 30 minute intervals) plotted along with the ambient air temperatures (logged at 30 minute and hourly intervals) and biogas temperatures (under the pond cover), for the period from June 2011 to May 2012. Similarly to the findings reported for PRJ-003003 (Skerman et al, 2011), this figure clearly shows less variation in pond effluent temperature than in the ambient air temperature. Furthermore, the pond effluent temperatures at depths of 1.0 and 1.8 m showed substantially less diurnal variation than the temperature at a depth of 0.3 m. This demonstrates that the effluent stored in the pond has a relatively high thermal mass which buffers fluctuations in the ambient air temperature. This buffering effect appears to increase with depth in the pond.

The average monthly temperature data is presented in Figure 19. This figure shows that the average monthly pond effluent temperature (at a depth of 1.8 m) varied from 16°C in July 2011 to 27°C in February 2012. The average monthly pond effluent temperature also closely followed the ambient air temperature, but was on average, approximately 3.7°C warmer. The average biogas temperature measured by the logger installed in the biogas collection box, near the cover outlet, was on average, approximately 7.6°C warmer than the ambient air temperature.

The average and logged biogas temperatures appeared to be increasing during March 2012. This may indicate a logger malfunction, or alternatively, the increase may have resulted from the removal of ponded stormwater from the pond cover surface. The stormwater which is intermittently temporarily stored on the surface of the pond cover may buffer biogas temperatures under the cover.

Unfortunately, the biogas temperature logger failed to provide credible results during some stages of the monitoring period. While the original logger was replaced in November 2011, the new logger once again gave spurious records over the period commencing in April 2012. The most likely reason for the logger failure appears to have been water ingress. This logger is now being replaced with a waterproof logger.

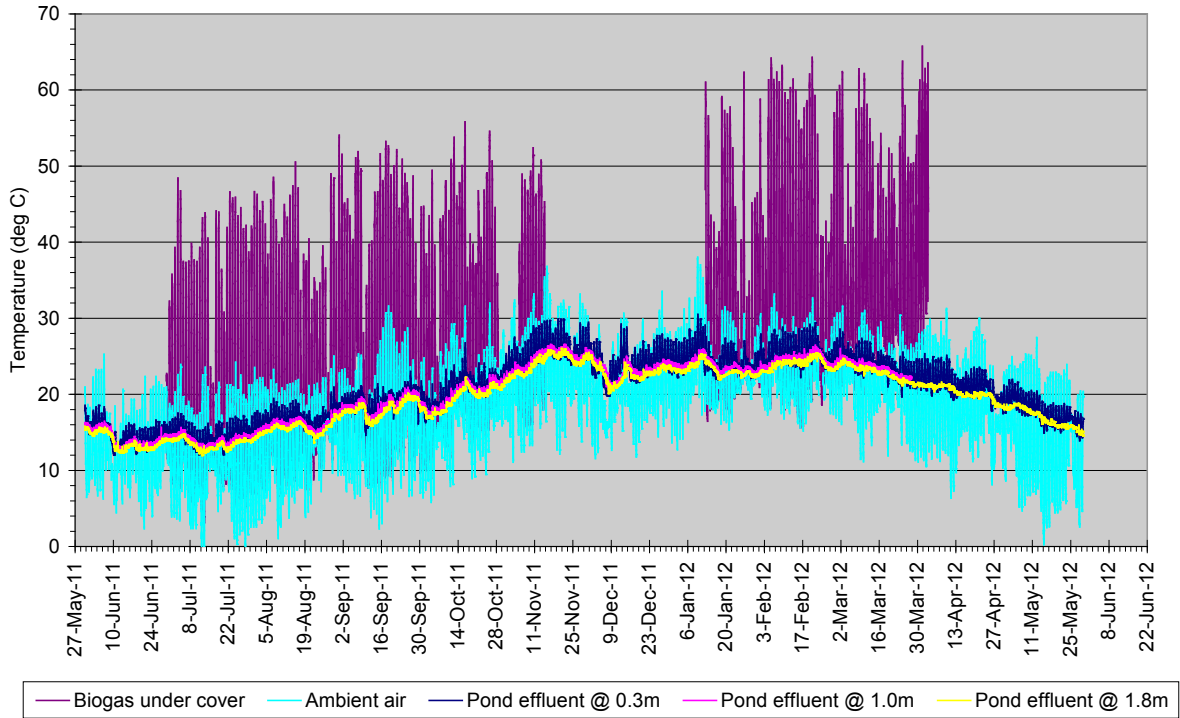

Figure 18. Ambient air, pond effluent and biogas temperatures logged at 30 minute and 1 hour intervals from June 2011 to May 2012.

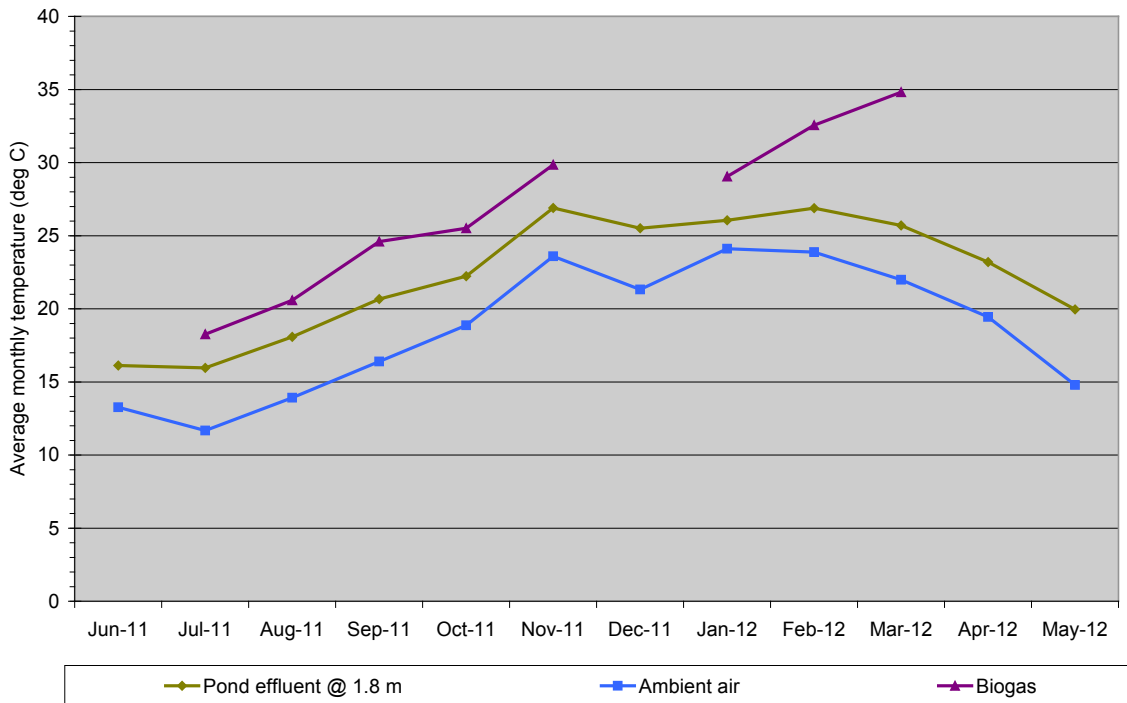

Figure 19. Average monthly ambient air, pond effluent and biogas temperatures.

Pond influent, effluent and sludge analysis results

Summaries of the total solids (TS), volatile solids (VS), pH and electrical conductivity (EC) analysis results determined at the Agri-Science Queensland (ASQ) laboratories for the 6 sampling dates are provided in Table 5.

Table 5. Summaries of the total solids (TS), volatile solids (VS), pH and electrical conductivity (EC) analysis results determined at the Agri-Science Queensland (ASQ) laboratories for 6 sampling dates.

Parameter	Sampling date						Average
	23-Aug-10	27-Sep-10	01-Nov-10	22-Nov-10	30-May-11	17-Nov-11	
Total solids (TS)							
Inflow TS	3.73%	3.41%	4.22%	2.30%		2.41%	3.22%
Outflow TS	0.43%	0.49%	0.43%	0.39%	0.38%	0.40%	0.42%
Sludge TS	10.17%	8.51%	23.47%	22.12%	11.01%	12.26%	14.59%
Volatile solids (VS)							
Inflow VS	2.84%	2.50%	2.98%	1.61%		1.74%	2.34%
Outflow VS	0.16%	0.18%	0.16%	0.14%	0.12%	0.15%	0.15%
Sludge VS	5.47%	4.90%	10.36%	10.24%	6.05%	6.79%	7.30%
pH							
Inflow pH	7.22	7.11	7.12	7.36		7.05	7.17
Outflow pH	7.52	7.36	7.41	7.63	7.32	7.35	7.43
Sludge pH	7.31	7.24	7.13	7.33	7.08	7.13	7.20
Electrical conductivity (EC)							
Inflow EC	7.95	8.40	11.05	7.83		9.14	8.87
Outflow EC	8.25	8.70	10.83	8.02	9.31	9.80	9.15
Sludge EC	5.46	6.20	6.33	4.52	6.8	6.98	6.05
Volatile solids / Total solids ratio (VS/TS)							
Inflow VS/TS	76%	73%	71%	70%		72%	72%
Outflow VS/TS	38%	36%	36%	36%	32%	37%	36%
Sludge VS/TS	54%	58%	44%	46%	55%	55%	52%

Based on the above analysis results, an average of 94% of the VS in the pond influent was removed in the partially covered primary pond. Some of the VS in the pond influent would have been converted to gaseous methane and carbon dioxide by the anaerobic digestion process, while the remaining VS would have been deposited as sludge on the base of the pond, or discharged with the pond effluent. The above results are consistent with the earlier monitoring results reported by Skerman *et al* (2011). The VS removal rate exceeds the average 64% VS removal rate reported by Birchall (2010) for the covered pond at the Bears Lagoon piggery, and the widely accepted 'standard' anaerobic pond VS reduction rate of 75%, as suggested by Kruger *et al* (1995).

Possible explanations for the higher VS removal rate include the lower loading rate ($0.20 \text{ kg VS} \cdot \text{m}^{-3} \cdot \text{day}^{-1}$) and longer hydraulic retention time (140 days) at the Grantham piggery in comparison to Bears Lagoon ($0.24 \text{ kg VS} \cdot \text{m}^{-3} \cdot \text{day}^{-1}$ screened; $0.41 \text{ kg VS} \cdot \text{m}^{-3} \cdot \text{day}^{-1}$ unscreened; 36 days). Alternatively, the higher average temperatures experienced at the Grantham facility may have improved the digestion efficiency.

The VS / TS ratios for the pond influent, effluent and sludge are reported in Table 5 and plotted against time in Figure 20. This figure clearly shows that the pond effluent has a significantly lower VS/TS ratio (average 36%) than both the pond sludge (52%) and influent (72%). Figure 20 also shows that there was minimal variation in the VS/TS ratios recorded over time.

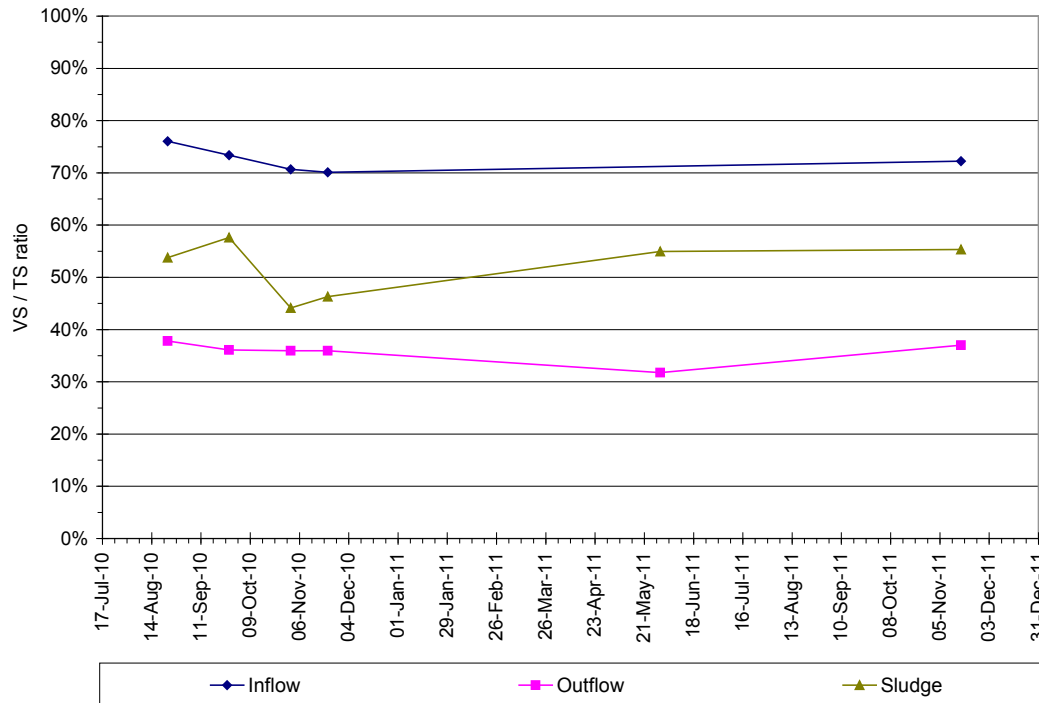

Figure 20. Volatile solids / total solids ratios for pond inflow, pond outflow and sludge samples.

Biogas composition monitoring

The results of the biogas composition monitoring to date are provided in Table 6. These results were obtained using a Geotech Biogas Check portable gas analyser. The average methane, carbon dioxide and hydrogen sulphide concentrations were 69%, 30% and 2018 ppm respectively.

Table 6. Biogas analysis results obtained using the Geotech Biogas Check portable gas analyser.

Date / time	Sample Location	CH ₄ %	CO ₂ %	O ₂ %	Balance %	H ₂ S ppm	CH ₄ /CO ₂
20/03/2012 14:43	Biogas filter	69.7	30.1	0.0	0.2	1236	2.32
20/03/2012 14:46	Biogas filter	70.6	29.3	0.0	0.1	1270	2.41
20/03/2012 14:49	Biogas filter	69.9	30.0	0.0	0.1	1177	2.33
20/03/2012 14:52	Biogas filter	70.0	29.9	0.0	0.1	1123	2.34
27/03/2012 14:56	Biogas filter	71.5	28.3	0.1	0.1	1572	2.53
27/03/2012 14:58	Biogas filter	71.2	28.7	0.0	0.1	1570	2.48
27/03/2012 15:01	Biogas filter	71.6	28.3	0.0	0.1	1589	2.53
23/04/2012 13:52	Biogas filter	66.6	32.3	0.4	0.7	1970	2.06
23/04/2012 13:54	Biogas filter	67.9	31.6	0.4	0.1	2172	2.15
23/04/2012 13:56	Biogas filter	67.3	32.2	0.4	0.1	2127	2.09
23/04/2012 13:58	Biogas filter	67.3	32.2	0.3	0.2	2143	2.09
8/05/2012 10:54	High pressure switch	67.9	31.6	0.4	0.1	1659	2.15
8/05/2012 10:56	High pressure switch	68.5	31.1	0.3	0.1	1647	2.20
8/05/2012 10:58	High pressure switch	68.0	31.6	0.3	0.1	1581	2.15
8/05/2012 11:15	Biogas filter	66.5	28.3	1.1	4.1	1685	2.35
8/05/2012 11:18	Biogas filter	67.3	29.0	1.1	2.6	1649	2.32
8/05/2012 11:21	Biogas filter	67.3	28.5	1.1	3.1	1654	2.36
15/05/2012 10:16	High pressure switch	68.9	30.9	0.0	0.2	2,416	2.23
15/05/2012 10:17	High pressure switch	69.0	30.9	0.0	0.1	2,396	2.23
15/05/2012 10:20	High pressure switch	69.4	30.5	0.0	0.1	2,399	2.28
15/05/2012 10:22	High pressure switch	68.9	31.0	0.0	0.1	2,369	2.22
24/05/2012 15:14	High pressure switch	69.7	29.8	0.1	0.4	3,241	2.34
24/05/2012 15:16	High pressure switch	69.4	30.4	0.0	0.2	3,233	2.28
24/05/2012 15:19	High pressure switch	69.4	30.4	0.1	0.1	3,284	2.28
24/05/2012 15:21	High pressure switch	69.4	30.4	0.0	0.2	3,292	2.28
Average:		68.9	30.3	0.2	0.5	2,018	2.28

Extension of biogas technology

In accordance with the project objectives, a range of activities were carried out to communicate the benefits of methane recovery and use as a clean energy source. These activities included hosting site visits by various groups, organising an on-farm field day, preparing and presenting formal papers at conferences and symposia, giving informal talks to a range of visiting groups, doing media interviews, and participating in television / video productions, as outlined below:

Formal presentations / conference papers

- 2 September 2010 Skerman, A. (2010) 'Biogas production using livestock manure and greenhouse gas reduction in Australia', International Symposium on Industrialization Plans of Biogas Production Using Livestock Manure, Agriculture Training Centre, National Institute of Animal Science (NIAS), Rural Development Administration (RDA), Suwon, Republic of Korea.
- 10 September 2010 Whitby, J. and Skerman, A. (2010) 'Next generation energy – Biogas?' Presentation to visiting delegation from Jilin Agricultural University, People's Republic of China.
- 9 December 2010 Skerman, A. G. (2010) 'Methane recovery and use at a piggery near Grantham, Qld', Bioenergy Australia Conference – Biomass for a clean energy future, Manly, NSW, 8 – 10 Dec 10.

Site visits / field days

- 24 November 2010 Members of the Sustainable Agricultural Initiative (SAI) Platform visited the Grantham piggery site as part of their field trip to South-East Qld. Project Leader, Alan Skerman provided an overview of the project to the visitors.
- 20 February 2011 Project Leader, Alan Skerman, met with three representative of Stanwell Corporation Ltd, on-site, at the Grantham piggery on 20 February 2012, to discuss biogas technology and the potential for the purchase of carbon credits from pig producers.
- 10 November 2011 The QNPH Grantham piggery was chosen as the site for the official launch of the Carbon Farming Initiative (CFI) 'Methodology for the destruction of methane generated from manure in piggeries' which was the first methodology approved under the CFI. The launch was carried out by Senator the Hon Joe Ludwig - Minister for Agriculture, Fisheries and Forestry in conjunction with the Hon Mark Dreyfus QC MP - Parliamentary Secretary for Climate Change and Energy Efficiency. This event received wide-spread national media coverage.
- 5 June 2012 A biogas Field Day was held at the QNPH piggery. Piggery owner, Jeremy Whitby, AM2MA Program Manager, Griff Rose and Research Project Leader, Alan Skerman addressed the attendees who were primarily pig producers, consultants and industry service providers. The Fact Sheet prepared for this field day is included in Appendix A of this report.

Media interviews

- 15 July 2011 Project Leader, Alan Skerman, was interviewed for an article entitled 'Piggery Power' which was published in the Rural Weekly (Southern Edition) on 15 July 2011.
- 11 November 2011 Following the CFI methodology launch, Project Leader, Alan Skerman, was interviewed by a journalist from the ABC Bush Telegraph program which went to air on Radio National on Friday, 11 November 2011.
- 11 November 2011 Project Leader, Alan Skerman, was also interviewed by a journalist from the Toowoomba Chronicle newspaper which published a front page story entitled, 'Pig Poo Power Promising' on 11 November 2011.

Television / video productions

- 26 May 2011 An ABC Landline crew visited the Grantham piggery site on 26 May 11 to film the pond cover and biogas system. They also interviewed the piggery co-owner, Jeremy Whitby, the APL Manager Environment and Climate Change, Janine Price, the research project leader, Alan Skerman, and the Methane to Markets Steering Committee Chairman, Ralph Leutton. This segment entitled "Carbon's Price" went to air on 5 June 2011.
- 25 May 2012 Research Project Leader, Alan Skerman, participated in the production of a video clip at the Grantham piggery, produced by DCCEE, to broadly illustrate an example of an activity that producers could consider implementing to reduce their GHG emissions while potentially earning carbon credits under the Carbon Farming Initiative (CFI). The video has been put up on the [Clean Energy Future](http://www.cleanenergyfuture.gov.au/video/grantham-piggery/) website (<http://www.cleanenergyfuture.gov.au/video/grantham-piggery/>) and may also be used in presentations to landholders, farmers and other stakeholders wanting to find out more about abatement activities that might be considered under the CFI.

Implications

GHG emission abatement

Federal Government estimates, at the time of the recent CFI methodology launch, indicated that there are approximately 690 piggeries in Australia which could potentially implement biogas collection and flaring/use systems. Without the implementation of abatement measures, annual piggery emissions are expected to be 1.3 Mt CO₂-e by 2020. It is estimated that an emission abatement of around 50% of this figure could be achieved through the installation of biogas collection and flaring/use systems, in accordance with the CFI methodology.

In systems where the biogas is used as an energy source for shed heating and/or electrical power generation, further reductions in GHG emissions will result, along with savings in energy costs.

This level of uptake by industry will not be achieved unless producers have confidence in the available technology and likely economic returns. The outcomes of this project have contributed to a reduction in risk associated with the adoption of the CFI methodology, particularly for smaller scale producers who may not be able to afford to employ specialist consultants and contractors to carry out the required design and installation.

In addition to GHG abatement, if Australian intensive livestock producers are going to benefit from the significant energy resources and resulting cost savings available from the collection and use of biogas, they will need practical guidance on the selection and operation of systems employing suitable technologies. These technologies must be robust, cost effective, and relatively simple to operate with minimal labour. The technologies developed and evaluated in this project were selected to meet these criteria.

Following the conclusion of the proposed performance monitoring period in June 2013, it is anticipated that the resulting findings will provide valuable guidance for intensive livestock producers contemplating the installation of biogas capture and use systems.

Piggery energy audit

As reported by Skerman *et al* (2011), an energy audit was carried out for the Grantham piggery over the 12-month period from April 2009 to March 2010. The results are summarised in Figure 21 which shows the electricity and liquid petroleum gas (LPG) energy usage at the piggery over this period.

Electricity is used to drive large cooling fans installed on the end walls of the piggery sheds. From Figure 21, it is clear that the peak electricity use occurs during the warm summer months. During the energy audit period, prior to the installation of the biogas water heating unit, LPG was the sole source of energy used to heat water circulated through the underfloor heating system in the farrowing sheds. Consequently, the LPG usage increased significantly during the cool winter months. These two energy sources accounted for virtually all of the energy used at the piggery.

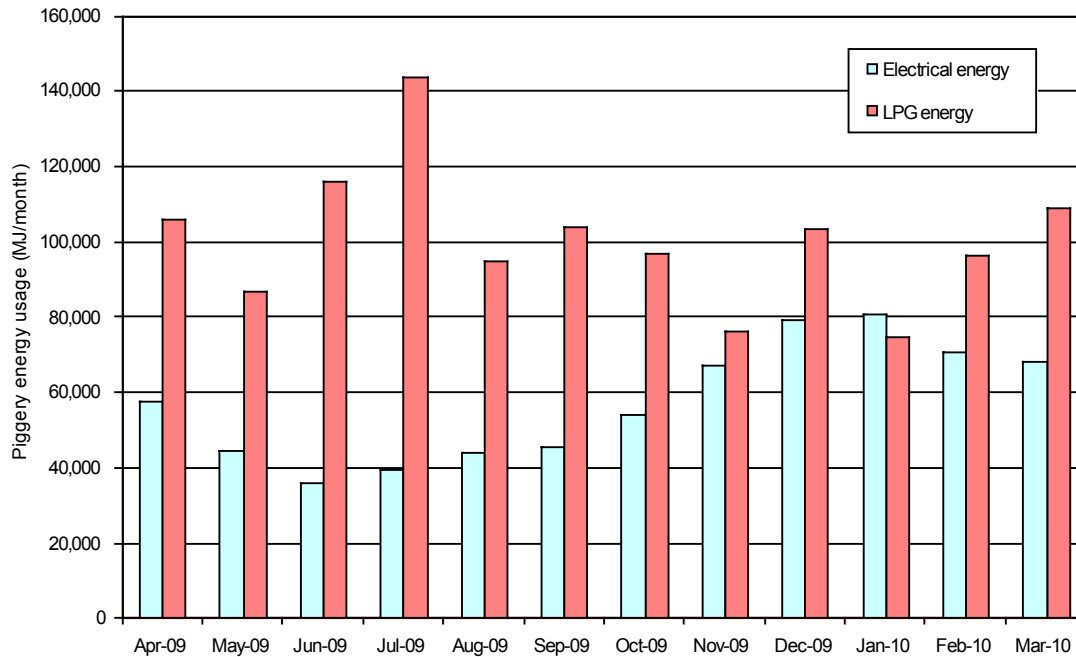

Figure 21. Results of an energy audit carried out for the Grantham piggery for the 12-month period from April 2009 to March 2010.

During the audit period, the piggery consumed 48,000 L of LPG at a cost of \$44,000 (average 92c/L). The energy value of this LPG was 1210 GJ/year, representing 64% of the total piggery energy usage.

Figure 22 is a printout from the Draft DAFF Qld biogas energy calculator for the Grantham piggery, based on the occupancy during the energy audit period. As reported by Skerman *et al* (2011), from the calculator printout, it is estimated that 587 GJ/year of primary (heat) energy could be provided by biogas. This represents approximately half of the LPG consumption and a potential cost saving of \$23,000 per year providing the biogas can be used successfully as a substitute for some of the LPG. These estimates were based on averaging the biogas production and heating demand over the year. In reality, it might not be possible to achieve this saving due to the seasonal nature of the biogas production and heating demand.

The total electricity usage over the 12 month audit period was 689 MJ/year (191,495 kW.hr/year) at a cost of \$32,000/year (average 17c/kW.hr). Electricity accounts for 36% of the total piggery energy usage.

The calculator printout in Figure 22 indicates that the available biogas could be used to generate 48,883 kW.hr/year of electrical power, based on a 30% electrical power generation efficiency. This represents 26% of the total piggery electrical power usage at a value of \$8300/year, based on an electricity cost of 17c/kW.hr. In addition to the electrical power generation, a combined heat and power (CHP) cogeneration system employing heat exchangers on the generator engine cooling and exhaust systems, could reclaim 50% of the primary biogas energy (293 GJ/year) which would otherwise be lost as waste heat. This energy could be used to heat water for circulation through the underfloor heating system. In terms of LPG replacement, this reclaimed heat could have a value up to \$11,497/year.

The feasibility of installing a combined heat and power (CHP) cogeneration system is examined in the following section.

Piggery biogas energy calculator

Draft Version 1.1, Nov 2011

Developed by: Alan Sletman, Agri-Science Queensland

Piggery / producer name:

ONPH Palabra piggery

Piggery locality:

Grantham

Parameter	Units	Value	Range	Reference
Piggery operating capacity	SPU	1,265		
Volatile solids (VS) production	kg VS/SPU/yr	90,910		FigBal
Standard piggery volatile solids (VS) production	kg VS/day	315		FigBal standard values
Estimated piggery volatile solids (VS) production	kg VS/day	315		
Volatile solids removal in solids separator	%	0%	0 - 25%	
Biogas production rate	m ³ /kg VS added	0.32	0.26 - 0.38	NWA, 2008
Daily biogas production	m ³ biogas/day	101		
Proportion of biogas captured by pond cover	%	63%	100% for fully covered pond	
Daily biogas collection	m ³ /day	63		
Biogas methane %	%	75%	55 - 70%	NWA, 2008
Daily methane collection	m ³ CH ₄ /day	48		
Annual methane collection	m ³ CH ₄ /year	17,355		
Methane energy value	MJ/m ³ CH ₄	33.8		NWA, 2008
Energy value	MJ/day	1,606		
Unit conversion	MJ/kWh	3.6		
Total primary energy potential	kWh/day	446		
Total primary power potential	kW	19.6		
Carbon credit value				
Estimated CO ₂ emission abatement	t CO ₂ -e/year	247		CCCEE, 2011
Carbon credit value	\$/t CO ₂ -e	52.3		
Estimated annual carbon credit value	\$/year	\$5,687		
Water heating potential				
Assumed boiler conversion efficiency	%	100%		NWA, 2008
Hourly primary energy (heating) potential	MJ/hr	67		
Daily primary energy (heating) potential	kWh/day	446		
Annual primary energy (heating) potential	kWh/yr	162,945		
LPG energy value	MJ/m ³ (liquid)	25,000		LPG Homegas
LPG required to replace biogas	L/yr	23,464		
Average LPG cost	\$/L	\$0.98		
Value of biogas as LPG heating substitute	\$/yr	\$22,995		
Combined heat and power (CHP) potential				
Generator electrical efficiency	%	30%		NWA, 2008
Daily electricity generation	kWh/day	134		
Annual electricity generation	kWh/yr	48,883		
Minimum generator size (continuous operation)	kW	5.6		
Average electricity cost	\$/kWh	\$0.17		
Value of generated electricity	\$/yr	\$8,310		
Generator heat recovery efficiency	%	50%		NWA, 2008
Hourly heating potential	MJ/hr	33		
Daily heat generation	kWh/day	223		
Annual heat generation	kWh/yr	81,472		
LPG required to replace biogas	L/yr	11,732		
Value of biogas as LPG heating substitute	\$/yr	\$11,497		
Total value of electricity and heat	\$/yr	\$19,808		

References:

NWA (National Institute of Water & Atmospheric Research), 2008, Covered Anaerobic Ponds for Anaerobic Digestion and Biogas Capture: Piggeries, NWA Information Series No 32, 2008; NWA New Zealand.

Figure 22. Draft DAFF Queensland Piggery biogas energy calculator printout for the Grantham piggery, based on April 2009 to March 2010 occupancy.

Cogeneration unit feasibility assessment

Combined heat and power (CHP) cogeneration systems consist of an electrical generator driven by an internal combustion engine fitted with heat exchangers which are used to reclaim otherwise wasted heat energy from the engine cooling system and exhaust. Due to delays in the installation of stages 1 and 2 of the biogas system and budgetary constraints, it was not possible to consider trialling a CHP system at the piggery during the course of this project. It will only be possible to confidently assess the feasibility of installing a CHP system after operational water heating records over an extended period become available.

Depending on seasonal biogas generation, there may be some potential for installing a relatively small (< 25 kW) internal combustion engine driven electrical generator which could be operated for several hours per day, either throughout the year, or only during the warmer months when biogas generation rates are higher and farrowing pen heating requirements lower. The waste heat from the engine could be used for shed heating.

A preliminary assessment of the feasibility of operating a CHP system was carried out, based on estimates of monthly biogas generation, and heating and cooling energy requirements. Regression equations were derived from energy audit data and the corresponding temperature data for the site over the audit period. These regression equations were used to estimate average monthly heating and cooling energy requirements based on average monthly temperatures. Monthly biogas production was also estimated using a temperature based regression equation, assuming the piggery was operating at near full capacity (1370 SPU). The biogas and energy estimates were standardised to sinusoidal forms having amplitudes based on recorded maximum and minimum values. The estimated monthly energy values are tabulated in Table 7 and have been plotted in Figure 23.

These estimates suggest that during a year when average temperature conditions prevail and the piggery operates at near full capacity, the biogas generated by the covered pond would be sufficient to supply approximately 62% of the annual piggery heating requirements, based on using all of the available biogas directly in a hot water system (HWS) for underfloor shed heating. On a monthly basis, the proportion of the heating requirement supplied by biogas falls to a minimum of 36% in July, with surplus biogas energy being available from December to February.

Alternatively, if the available biogas is used to supply a CHP system throughout the year, it is estimated that it could supply 30% of the electrical energy and 32% of the heat energy required by the piggery annually.

An alternative option could involve using all of the available biogas to supply a hot water system during winter (when heating demands are higher) and running the CHP system during summer (when heating demands are lower and electrical fan cooling power demands are higher). Based on this operating scenario, it is estimated that 17% and 46% of the annual electrical and heating energy requirements, respectively, could be supplied by the biogas.

While the results of this preliminary feasibility assessment should be considered with caution, the installation of a CHP system may provide the producer with greater flexibility for utilising the available biogas energy. However, any economic benefit is likely to be marginal in comparison to using all of the available biogas for underfloor farrowing shed heating. As previously noted, a more definitive assessment will be possible when the additional operational monitoring data becomes available.

Table 7. Monthly estimates of piggery energy requirements, biogas generation and energy supplied for hot water system (HWS) and CHP options.

Month	Heat energy required (MJ/mth)	Elec energy required (MJ/mth)	Biogas volume available (m ³ /mth)	Primary heat energy available (MJ/mth)	% Heat energy supplied (HWS) (%)	% Heat energy supplied (CHP) (%)	% Elec energy supplied (CHP) (%)
Jan	62,280	77,660	2,923	74,110	100%	59%	29%
Feb	66,050	75,163	2,840	71,999	100%	55%	29%
Mar	76,351	68,341	2,613	66,232	87%	43%	29%
Apr	90,422	59,021	2,302	58,354	65%	32%	30%
May	104,493	49,702	1,991	50,476	48%	24%	30%
Jun	114,794	42,880	1,764	44,709	39%	19%	31%
Jul	118,564	40,382	1,680	42,598	36%	18%	32%
Aug	114,794	42,880	1,764	44,709	39%	19%	31%
Sep	104,493	49,702	1,991	50,476	48%	24%	30%
Oct	90,422	59,021	2,302	58,354	65%	32%	30%
Nov	76,351	68,341	2,613	66,232	87%	43%	29%
Dec	66,050	75,163	2,840	71,999	100%	55%	29%
Total	1,085,064	708,255	27,623	700,249	62%	32%	30%

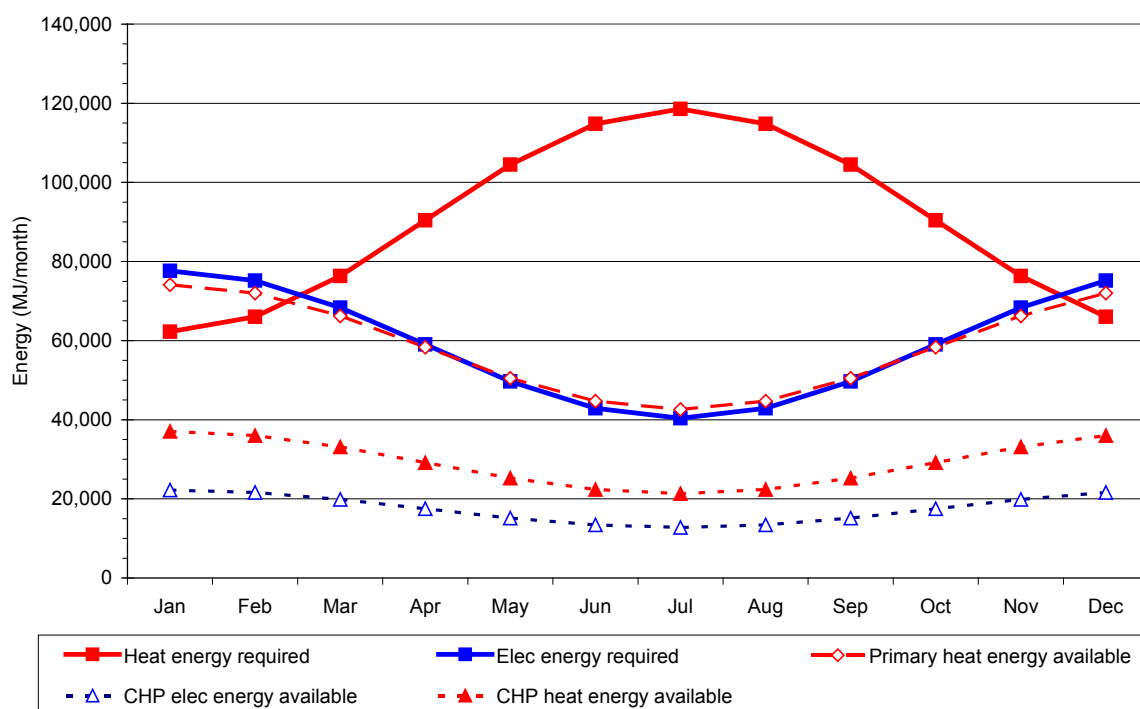

Figure 23. Monthly estimates of piggery energy requirements and biogas energy availability for primary hot water system and CHP biogas use options.

Business case

System cost

The costs (\$AUD incl. GST) involved in supplying and installing the various components of the biogas collection and use system at the Grantham piggery are listed below:

Design, supply and install pond cover and original biogas extraction system	\$148,170
Materials and associated equipment	\$87,835
Freight to the piggery	\$3,740
Installation	\$56,595
Upgrade biogas extraction system	\$56,650
Supply hot water system	\$3,992
Supply and install biogas reticulation pipeline, convert and install water heater	\$45,364
<u>Electrical work</u>	<u>\$5,016</u>
<u>Total cost</u>	<u>\$259,192</u>

It should be noted that the above costs may not accurately reflect current costs likely to be incurred for the supply and installation of a new biogas collection and use system at a commercial piggery, for the following reasons:

- The Grantham biogas system was installed as a demonstration system, incorporating technology that had not been previously used in the Australian pig industry.
- Since the original installation, a number of Australian companies are now offering biogas system design and installation services, and have gained valuable experience in planning and installing a limited number of new systems.
- The cost of some system components has fallen since the Grantham system was originally installed.
- Full pond covers, trenched into the pond bank, are likely to be less expensive (per unit area) than the floating, partial cover installed at Grantham, primarily because they do not require the relatively expensive flotation pipe around the perimeter.
- The Grantham installation was carried out in accordance with government procurement policy which may be more restrictive than practices used in private industry.
- The above costs include upgrading work which should not be required for a properly designed commercial system.

Expected returns

Figure 24 is a copy of the printout from the draft 'Piggery biogas energy calculator' (Skerman, 2011) for the Grantham piggery, based on near full occupancy (1370 SPU). In this calculator printout, the proportion of biogas captured by the pond cover has been adjusted to give the estimated average biogas production used in the cogeneration unit feasibility assessment. This printout is intended to reflect the biogas production from the piggery when it is operating under average climatic conditions,

at near full capacity. The expected economic returns from the system, as determined by the calculator, are summarised below. These estimates are based on preferentially using the available biogas energy for heating the farrowing sheds by circulating hot water through the underfloor heating pads:

Value of biogas as an LPG heating substitute:	\$25,876 / year
<u>Carbon credit value under the CFI:</u>	<u>\$6,399 / year</u>
<u>Total annual returns:</u>	<u>\$32,275 / year</u>

In simple terms, this implies an 8 year payback period on the capital investment, without considering ongoing operation and maintenance costs, depreciation and interest repayments. This payback period may have been reduced to approximately 6 years if the original biogas extraction system had been designed and installed to the required standard, negating the need for the system upgrade.

As noted previously, it is anticipated that a full perimeter pond cover, secured in a trench around the bank, could now be installed at a significantly lower cost per unit area. This would result in the collection of greater volumes of biogas at a reduced capital cost, further reducing the payback period. It should be noted that the Grantham pond cover was retrofitted to an existing anaerobic pond and the piggery farrowing sheds already had underfloor heating pads and a hot water circulation system installed. In many cases, additional expenditure may be required for the construction of a new pond and the installation of a heating system.

It should be noted that the above costs may not accurately reflect current costs likely to be incurred for the supply and installation of a new biogas collection and use system, at a commercial piggery, for the following reasons:

- The Grantham biogas system was installed as a demonstration system, incorporating technology that had not been previously used in Australia.
- Since the original installation in 2009, a number of Australian companies are now offering biogas system design and installation services, and have gained valuable experience in planning and installing a limited number of new systems.
- The cost of some system components has fallen since the Grantham system was originally installed.
- Full pond covers, trenched into the pond bank, are likely to be less expensive (per unit area) than the floating, partial cover installed at Grantham, primarily because they do not require the relatively expensive flotation pipe around the perimeter.
- The Grantham installation was carried out in accordance with government procurement policy which may be more restrictive than practices used in private industry.
- The above costs include upgrading work which should not be required for a properly designed commercial system.

Piggery biogas energy calculator

Draft Version 1.1, Nov 2011

Developed by Alan Sherman, Agri-Science Queensland

Piggery / producer name:

ONPR Palahra piggery

Piggery locality:

Grantham

Parameter	Units	Value	Range	Reference
Piggery operating capacity	SPU	1,370		
Volatile solids (VS) production	kg VS/SPU/yr	90,91		Pig@a1
Standard piggery volatile solids (VS) production	kg VS/day	341		Pig@a1 standard values
Estimated piggery volatile solids (VS) production	kg VS/day	341		
Volatile solids removal in solids separator	%	8%	0 - 25%	
Biogas production rate	m ³ /kg VS added	0.32	0.26 - 0.38	NWA, 2008
Daily biogas production	m ³ biogas/day	179		
Proportion of biogas captured by pond cover	%	78%	100% for fully covered pond	
Daily biogas collection	m ³ /day	76		
Biogas methane %	%	78%	56 - 70%	NWA, 2008
Daily methane collection	m ³ CH ₄ /day	53		
Annual methane collection	m ³ CH ₄ /year	19,529		
Methane energy value	MJ/m ³ CH ₄	33.8		NWA, 2008
Energy value	MJ/day	1,007		
Unit conversion	MJ/kW.hr	3.6		
Total primary energy potential	kW.hr/day	502		
Total primary power potential	kW	20.9		
Carbon credit value				
Estimated CO ₂ emission abatement	t CO ₂ -e/year	278		DOCEE, 2011
Carbon credit value	\$/t CO ₂ -e	323		
Estimated annual carbon credit value	\$/year	\$6,389		
Water heating potential				
Assumed boiler conversion efficiency	%	100%		NWA, 2008
Hourly primary energy (heating) potential	MJ/hr	75		
Daily primary energy (heating) potential	kW.hr/day	502		
Annual primary energy (heating) potential	kW.hr/yr	183,360		
LPG energy value				
LPG energy value	MJ/m ³ (liquid)	25,000		LPG Homogas
LPG required to replace biogas	L/yr	26,404		
Average LPG cost	\$/L	\$9.38		
Value of biogas as LPG heating substitute	\$/yr	\$25,876		
Combined heat and power (CHP) potential				
Generator electrical efficiency	%	30%		NWA, 2008
Daily electricity generation	kW.hr/day	151		
Annual electricity generation	kW.hr/yr	55,008		
Minimum generator size (continuous operation)	kW	6.3		
Average electricity cost	\$/kW.hr	\$8.17		
Value of generated electricity	\$/yr	\$9,351		
Generator heat recovery efficiency				
Generator heat recovery efficiency	%	50%		NWA, 2008
Hourly heating potential	MJ/hr	38		
Daily heat generation	kW.hr/day	251		
Annual heat generation	kW.hr/yr	91,680		
LPG required to replace biogas				
LPG required to replace biogas	L/yr	13,202		
Value of biogas as LPG heating substitute	\$/yr	\$12,938		
Total value of electricity and heat	\$/yr	\$22,289		

References:

NWA (National Institute of Water & Atmospheric Research), 2008, Covered Anaerobic Ponds for Anaerobic Digestion and Biogas Capture: Piggeries, NWA Information Series No 32, 2008; NWA New Zealand.

Figure 24. Draft DAFF Queensland Piggery biogas energy calculator printout for the Grantham piggery, based on near full occupancy (1370 SPU) and the estimated average biogas production used in the cogeneration unit feasibility assessment.

Conclusions

The biogas extraction system located near the north-western corner of the partially covered pond has now been upgraded to meet Queensland legislative requirements and standards. This highlights the need to ensure that all new biogas developments are designed, installed and operated in accordance with the relevant legislation and standards which are quite variable between the Australian states and internationally. This will ensure that potentially costly refits are avoided.

The biogas reticulation pipeline has been installed between the extraction system and a biogas-fired water heating system located between piggery sheds. An electrical control system has been installed to automatically operate the biogas heater in conjunction with the existing LPG-fired heater previously used as the sole source of farrowing shed heating. These additions allow the pig producer to make productive use of the significant biogas energy source, thereby reducing farm energy costs along with GHG emissions.

The temperature data collected during this project was consistent with data collected during PRJ-003003 (Skerman *et al*, 2011). The relatively high thermal mass of the effluent stored in the pond resulted in more stable pond effluent temperatures in comparison to the ambient air temperatures recorded at the site. This buffering effect appeared to increase with depth in the pond. The minimum monthly average effluent temperature at a depth of 1.8 m was 16°C, which is 3°C warmer than the value recorded at the Bear's Lagoon piggery by Birchall (2010). The resulting higher average effluent temperature is likely to result in comparatively higher biogas production rates with less variation over the cooler months.

Analyses of the effluent discharged from the partially covered primary pond showed a 94% reduction in the average volatile solids (VS) concentration, in comparison to the pond influent. This result is consistent with data collected during PRJ-003003 (Skerman *et al*, 2011) and is indicative of healthy pond microorganism activity.

Biogas composition analyses suggested average methane, carbon dioxide and hydrogen sulphide concentrations of 69%, 30% and 2000 ppm, respectively. This average methane concentration is consistent with the value reported by Skerman *et al* (2011) and the default value adopted in the CFI methodology.

A preliminary assessment of the potential for installing a CHP system suggested that a CHP system may provide the producer with greater flexibility for utilising the available biogas energy. However, any economic benefit is likely to be marginal in comparison to using all of the available biogas for underfloor farrowing shed heating. A more definitive assessment will be possible when the additional operational monitoring data becomes available.

It is anticipated that the costs incurred in establishing the biogas system at the Grantham piggery could be recouped over an eight year payback period, based on estimated reductions in LPG heating costs and revenue from carbon credits. This simple analysis has not considered ongoing operation and maintenance costs, depreciation and interest repayments. The payback period may have been reduced to approximately 6 years if the original biogas extraction system had been designed and installed to the required standard, negating the need for the system upgrade.

It is anticipated that pig producers will be able to establish new biogas collection and use systems at lower costs than those incurred at the Grantham piggery, for the following reasons:

- The Grantham biogas system was installed as a demonstration system, incorporating technology that had not been previously used in the Australian pig industry.

- Since the original installation in 2009, a number of Australian companies are now offering biogas system design and installation services, and have gained valuable experience in planning and installing a limited number of new systems.
- The cost of some system components has fallen since the Grantham system was originally installed.
- Full pond covers, trenched into the pond bank, are likely to be less expensive (per unit area) than the floating, partial cover installed at Grantham, primarily because they do not require the relatively expensive flotation pipe around the perimeter.
- The Grantham installation was carried out in accordance with government procurement policy which may be more restrictive than practices used in private industry.
- The costs incurred at the Grantham site included upgrading work which should not be required for properly designed commercial systems.

Due to delays in upgrading the original biogas system and installing the new pipeline and heating system at the piggery, limited water heating system monitoring data is currently available. To maximise the benefits resulting from the significant investment already made in establishing the facilities at the Grantham piggery, an extension to this project has been negotiated to enable the collection of additional monitoring data by the end of June 2013. The resulting data will assist in resolving outstanding technical issues while providing producers with clear evidence of the potential benefits and costs associated with the installation and operation of biogas collection and use systems. Following the conclusion of the extended performance monitoring period, it is anticipated that the resulting findings will be included in a revision to this report, which will be available from the RIRDC website.

Recommendations

An addendum to this Final Report (or a revised Final Report) will be prepared following the conclusion of the extended monitoring period. It will be available from the RIRDC website.

Because it was not feasible to install a CHP cogeneration system at the Grantham piggery during the course of this project, it is recommended that further case studies be carried out at piggeries where CHP systems have been either recently installed or are about to be installed in the near future. Operational data and experience gained from these piggeries will assist other producers interested in installing similar systems. These case studies should be carried out at piggeries of various sizes, at different climatic locations which are representative of the Australian pig industry.

References

- Birchall, S. (2010) *Biogas production by covered lagoons – Performance data from Bears Lagoon piggery*, RIRDC Project No PRJ-002705, RIRDC Publication No 10/023
- Casey, K.D., McGahan, E.J., Atzeni, M.A. Gardner, E.A. & Frizzo, R.E. (1996). *PIGBAL; A nutrient balance model for intensive piggeries*. Queensland Department of Primary Industries. (Version 3.1, 2003).
- DCCEE (Department of Climate Change and Energy Efficiency), 2011. *Carbon Farming Initiative: Methodology for the destruction of methane generated from manure in piggeries*, Approved. [http://www.climatechange.gov.au/government/initiatives/carbon-farming-initiative/methodology-development/approved-methodologies/~media/government/initiatives/cfi/methodology-development/methodologies-under-consideration/CFI-MethanePiggeriesMethodology-20111205-PDF.pdf](http://www.climatechange.gov.au/government/initiatives/carbon-farming-initiative/methodology-development/approved-methodologies/~/media/government/initiatives/cfi/methodology-development/methodologies-under-consideration/CFI-MethanePiggeriesMethodology-20111205-PDF.pdf)
- Krich K., Augenstein, D., Batmale, J. P., Benemann, J., Rutledge, B. and Salour, D., 2005. *Biomethane from Dairy Waste - A Sourcebook for the Production and Use of Renewable Natural Gas in California*, Prepared for Western United Dairywomen, Funded in part through USDA Rural Development. http://www.calstart.org/Libraries/Publications/Biomethane_from_Dairy_Waste_Full_Report.sflb.ashx
- Kruger, I., Taylor, G and Ferrier, M. (compiled and edited by) (1995). *Effluent at work*, Australian pig housing series, NSW Agriculture, Tamworth NSW.
- Mears, D., 2001. *Biogas Applications for Large Dairy Operations: Alternatives to Conventional Engine-Generators*, Prepared under contract to Cornell Cooperative Extension Association of Wyoming County, Warsaw, NY. Final Edition. http://www.manure.umn.edu/assets/cornell_biogas_applications.pdf
- National Institute of Water and Atmospheric Research Ltd (NIWA), New Zealand (2008). *Covered anaerobic ponds for anaerobic digestion and methane capture: piggeries*, NIWA Information Series 32 2008.
- Skerman, A., Collman, G., and Pott, L., 2011. *Biogas production by covered lagoons – QNPH piggery, Grantham Qld*, Final Report - RIRDC Project No PRJ-003003, RIRDC, Barton, ACT.
- Skerman, A., Collman, G., Sohn, J.H. and Pott, L., 2012. *Options for biogas cleaning and use on-farm*, Final Report - RIRDC Project No PRJ-004547, RIRDC, Barton, ACT.
- Skerman, A., 2011. *Piggery biogas energy calculator*, draft version 1.3, Department of Agriculture, Fisheries and Forestry (DAFF) Queensland.
- Walsh, J.L., Ross, C.R., Smith, M.S., Harper, S.R. and Wilkins, W.A., 1988. *Handbook on biogas utilisation*, Published by the Environment, Health and Safety Division, Georgia Tech Research Institute, Atlanta, Georgia, for US Department of Energy <http://infohouse.p2ric.org/ref/22/21262.pdf>
- Wiedemann, S., McGahan, E., Grist, S. and Grant, T., 2010. *Environmental Assessment of Two Pork Supply Chains Using Life Cycle Assessment*, RIRDC Publication No 09/176, RIRDC Project No PRJ-3176 and PRJ-4519 <https://rirdc.infoservices.com.au/downloads/09-176.pdf>

Appendices

Appendix A – Biogas Field Day Fact Sheet

Fact Sheet

Biogas Field Day

QNPH Grantham piggery
Tuesday, 5 June 2012



Project funding

- Biogas system installed under Australian Methane to Markets in Agriculture (AM2MA) program, administered by RIRDC and funded by Climate change research, Natural Heritage Trust and National Landcare programs administered by Department of Agriculture, Fisheries and Forestry (DAFF).
- Research projects carried out by Department of Agriculture, Fisheries and Forestry (DAFF Qld, formerly DEEDI and DPI).

Piggery

- Queensland Natural Pork Holdings (QNPH) Palahra piggery, Roses Road, Grantham, Qld.
- 700 sow breeder unit, weaned piglets transported offsite at 3 – 4 weeks of age, 1600 pigs, 1400 SPU.
- 4 static pit sheds, effluent released into 1.7 ML primary pond weekly, 1.5 ML secondary pond.
- Primary pond loading rate: $0.2 \text{ kg VS.m}^{-3}.\text{day}^{-1}$, Hydraulic retention time: 130 days (approx).

Pond cover

- Partial floating cover installed in Feb 2009 by Waste Solutions (Dunedin, NZ).
- Dimensions: 30 m x 25m, covering approx half pond surface area.
- 500 mm dia HDPE flotation pipe heat welded around perimeter.
- 1.5 mm HDPE sheeting heat welded to perimeter piping.
- Cover fabricated beside pond, launched with an excavator.
- AM2MA Steering Committee keen to trial partial, floating cover as a retro-fit option for existing ponds.
- Potentially easier to desludge than a full cover secured in a perimeter trench.
- Higher capital cost.

Key biogas system components

- **Flare:** Landfill Service Corporation Solar Spark Vent Flare CF-5.
- **Gas pressure booster:** Secomak Model 576.
- **Hot water system:** Rheem Model 631265NO heavy duty (converted to run on biogas).
- **Gas meter:** Landis+Gyr Model 750 with Elster IN-Z61 pulse transmitter.

Gas safety legislation

- In Qld, all biogas collection / use systems must be installed and operated in accordance with the provisions of the *Petroleum and Gas (Production and Safety) Act and Regulation 2004*.
- System installation must be carried out by an authorised gas installer working under an authorisation covering Type B (industrial) gas installations.
- Use of Polyethylene and UPVC pipe work or fittings above ground is prohibited.
- Contractor must supply a certificate of compliance for the installation and a certificate of approval sourced from a type B gas device approval authority.
- The operator must develop a Safety Management Plan which includes a risk assessment.
- Further information on Qld gas safety requirements can be accessed at:
<http://mines.industry.qld.gov.au/safety-and-health/petroleum-gas-safety.htm>

Cost

	<u>\$AUD incl GST</u>
• Design, supply and install pond cover and original biogas extraction system	\$148,170
• Upgrade biogas extraction system	\$56,650
• Supply hot water system	\$3,992
• Supply and install biogas reticulation pipeline, convert and install water heater	\$45,364
• Electrical work	\$5016

¹ *It is expected that a new system, incorporating a full cover, trenched into the pond bank, could be installed at a lower cost. The above costs also include upgrading work which should not be required for a properly designed commercial system.*

Research

- Monitor biogas system operation:
Biogas quantity and quality; pond effluent, biogas and ambient air temperatures.
- Sample and analyse effluent entering and leaving pond and sludge deposited on base of pond.
Samples analysed by PhD student at UQ AWMC and DAFF Qld labs.

Research project findings

- Biogas yield: Average 65 m³/day biogas, (21% increase in summer, 23% decrease in winter).
- Biogas composition: 69% methane, 30% carbon dioxide, 2000 ppm hydrogen sulphide.
- 48 m³/day methane, 1600 MJ/day heat energy = 67 MJ/hour, 446 kW.hr/day heat.
- \$23,000/yr replacement LPG value.

Combined heat and power (CHP) cogeneration option

- Approx 30% of gas energy can be converted to electrical energy using engine driven generator.
- Can recover approx 50% of gas energy as heat from engine cooling system and exhaust.

Carbon emission abatement

- 0.68 t CO₂e/day, 250 t CO₂e/yr @ \$23/t = \$5745 (possible carbon credits under CFI methodology)

More information

Alan Skerman, Principal Environmental Engineer, DAFF (Qld), Toowoomba.
Phone: 07 4688 1247, Mobile: 0407 462 529, Email: alan.skerman@daff.qld.gov.au

Appendix B – Safety Management Plan

Prepared under section 675 of the *Petroleum and Gas (Production and Safety) Act 2004*

(Some personal details have been removed from this plan for privacy reasons)

Safety Management Plan

Prepared under section 675 of the *Petroleum and Gas (Production and Safety) Act 2004*

Queensland Natural Pork Holdings

Palahra piggery biogas system

Roses Road, Grantham, Queensland



Alan Skerman

Version 4.0 – June 2012

Table of contents

Foreword	iii
Acknowledgments	iv
Abbreviations	iv
Executive Summary	x
What the report is about.....	x
Who is the report targeted at?	x
Where are the relevant industries located in Australia?	x
Background.....	x
Aims/objectives	xi
Methods used.....	xi
Results/key findings.....	xi
Implications for relevant stakeholders:.....	xii
Recommendations	xii
Introduction	1
Background.....	1
Piggery details	1
Biogas collection system details.....	3
Objectives	5
Methodology	6
Biogas extraction system upgrade	6
Stage 1 – Upgrade of biogas extraction system	7
Stage 2 – Installation of biogas reticulation pipeline and water heating system	8
Water heating control system operation	14
Operational data collection.....	14
Sampling.....	16
Pond influent sampling	16
Pond effluent sampling	17
Pond sludge sampling	19
Sample Analysis	20
Biogas quality monitoring	20
Results	21
Temperature data	21
Pond influent, effluent and sludge analysis results	23
Biogas composition monitoring.....	25

Extension of biogas technology.....	26
Formal presentations / conference papers.....	26
Site visits / field days.....	26
Media interviews.....	27
Television / video productions.....	27
Implications	28
GHG emission abatement.....	28
Piggery energy audit.....	28
Cogeneration unit feasibility assessment.....	31
Business case.....	33
System cost.....	33
Expected returns.....	33
Conclusions.....	36
Recommendations	Error! Bookmark not defined.
References.....	39
Appendices.....	40
Appendix A – Biogas Field Day Fact Sheet.....	40
Appendix B – Safety Management Plan.....	3
1. Description of plant, its location and operations:	1
1.1 Plant.....	1
1.1.1 General.....	1
1.1.2 Pond cover.....	2
1.1.3 Biogas extraction and use system.....	3
1.1.4 Piggery shed heating system.....	5
1.2 Location.....	8
1.3 Operation.....	9
1.3.1 Description.....	9
1.3.2 Contact details:.....	9
1.3.2.1 DAFF (Qld) research staff.....	9
1.3.2.2 Piggery management.....	9
2. Organisational safety policies	10
2.1 DAFF Queensland.....	10
2.2 Queensland Natural Pork Holdings (QNPH).....	11
3. Organisational structure and safety responsibilities.....	12
4. Plant sites for which a site safety manager is required.....	13

5.	Formal safety assessment	14
6.	Interaction with other operating plant or contractors.....	20
7.	Skills assessment.....	20
8.	Training and supervision program	22
9.	Safety standards and standard operating procedures.....	22
10.	Control systems	24
11.	Machinery and equipment relating to safety	25
12.	Emergency equipment preparedness and procedures.....	26
13.	Communication systems.....	26
14.	Mechanism for implementing, monitoring, reviewing and auditing safety policies and safety management plans	27
15.	Key performance indicators	27
16.	Mechanisms for investigating, recording and reviewing incidents at the plant	27
17.	Record management	28
18.	Application of the Workplace Health and Safety Act 1995	28
19.	Major hazard facilities	28
20.	Additional risks	28
21.	Additional legislative obligations.....	28

Tables

Table 1. Details of biogas extraction and use system components.....	5
Table 2. Properties of methane gas.	14
Table 3. Hazard assessment table.	16
Table 4. Responsibilities, skills and training required to carry out research and operational tasks in the vicinity of the biogas system.	21

Figures

Figure 1. Aerial view showing piggery sheds and partially covered pond.	1
Figure 2. Floating pond cover installed on piggery anaerobic effluent pond.	3
Figure 3. Biogas extraction system installed adjacent to the north-western corner of the primary effluent pond.	4
Figure 4. Schematic drawing of the biogas extraction and use systems.	4
Figure 5. Biogas piping system used to convey biogas from the biogas extraction system to the water heating system.	7
Figure 6. Aerial photograph showing the locality of the piggery and associated biogas collection and use system.....	8
Figure 7. Organisational structure showing current relationships between piggery and research project management.	12
Figure 8. DAFF organisational structure.	13
Figure 9. Risk priority chart (WHS Qld, 2008).	15
Figure 10. Risk scores and actions (WHS Qld, 2008).	15

1. Description of plant, its location and operations:

1.1 Plant

1.1.1 General

The biogas plant consists of a rectangular, floating, high density polyethylene (HDPE) cover (approximately 30 m x 25 m) which was retrofitted on an existing piggery effluent pond in February 2009. The partial pond cover was designed and installed by Waste Solutions Ltd, based in Dunedin, New Zealand (www.wastesolutions.co.nz).

The cover collects an average of approximately 70 m³ of biogas per day, emitted from the pond surface. Analyses suggest that the biogas consists of approximately 70% methane, 30% carbon dioxide and 1000 – 3000 ppm hydrogen sulphide, with an estimated energy value of 1600 MJ/day. The biogas is piped to an extraction system installed adjacent to the north-west corner of the pond. An aerial photograph showing the piggery sheds and partially covered effluent pond is provided in Figure 25.



Figure 25. Aerial view showing piggery sheds and partially covered pond.

Funding for the biogas system design and installation was provided as part of a research project entitled 'Biogas production by covered lagoons' under the Australian Methane to Markets in Agriculture (AM2MA) program, administered by the Rural Industries Research

and Development Corporation (RIRDC). This project was undertaken by researchers from the Department of Agriculture, Fisheries and Forestry (DAFF Qld).

1.1.2 Pond cover

The pond cover was constructed using lengths of 500 mm diameter HDPE pipe that were heat welded to form a continuous, rectangular tube, providing flotation around the perimeter of the cover. Heat welded bags fabricated from 1.5 mm HDPE sheeting were filled with polystyrene beads and installed under the cover in a cross formation to provide additional flotation. HDPE sheeting of 1.5 mm thickness was continuously heat welded to the 500 mm diameter perimeter flotation piping to form the impermeable cover. A photograph of the completed pond cover is provided in Figure 26.

At least one biogas vent/storm water drainage pipe was installed approximately in the centre of each of the four rectangular quadrants formed by the cross-ways flotation bags. These vent/storm water drainage pipes which are approximately 1.5 m long, were installed approximately flush with the upper surface of the cover and extend down into the underlying effluent. As rainwater pools on the surface of the cover, these pipes allow excess water to drain into the underlying effluent pond. In the event that the gas pressure under the cover increases to such an extent that the cover inflates vertically, the lower ends of the vent/drainage pipes can potentially rise above the effluent surface, venting excess biogas to the atmosphere.

Biogas collected under the cover moves primarily around the perimeter of the cover to a raised, heat-welded HDPE gas collection box installed on the north-western corner of the cover. A short, flexible PE pipeline connects this biogas collection box to the adjacent biogas extraction system.



Figure 26. Floating pond cover installed on piggy anaerobic effluent pond.

1.1.3 Biogas extraction and use system

A photograph of the biogas extraction system is provided in Figure 28 while a schematic drawing of the biogas extraction and use systems is provided in Figure 27. The components of this system are described in Table 1.



Figure 27. Biogas extraction system installed adjacent to the north-western corner of the primary effluent pond.

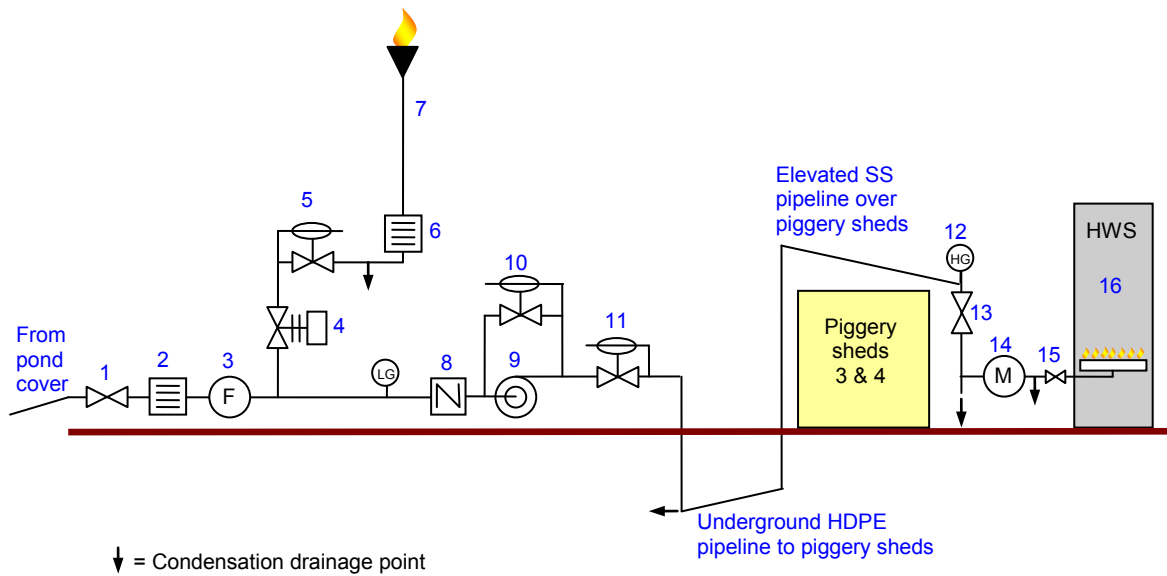

Figure 28. Schematic drawing of the biogas extraction and use systems.

Table 8. Details of biogas extraction and use system components.

Item No	Item description	Manufacturer	Type
1	Isolating valve		
2	Flame arrester	Groth Corporation	Model No: 7628-02-55-F00
3	Filter		
4	N/O (normally open) pneumatically actuated valve	Norbro	40R
5	Forward feed relief regulator		
6	Flame arrester	Landfill Service Corporation	Inline stainless steel wire-gauze - built into flare
7	Flare	Landfill Service Corporation	Solar Spark Vent Flare CF-5
8	Low gas pressure switch	Beta	Vacuum pressure switch W8-V304-S1N-P5-N1
9	Non return valve		
10	Gas pressure booster	Secomak	Model 576
11	Forward feed relief regulator		
12	Forward feed relief regulator		
13	High gas pressure switch		
14	Isolating valve		
15	Gas flow meter	Landis+Gyr	Model 750 with elster IN-Z61 pulse output
16	Isolating valve		
17	Hot water system	Rheem	Model 631265NO
21	Flame arrester		

As shown in Figure 5, biogas is piped from the extraction system (located near the north-west corner of the primary effluent pond), to the water heating system (located between piggery sheds 2 and 3), via an underground 100 mm and 63 mm HDPE pipeline and above ground 50 mm diameter stainless steel pipeline, across the rooves of piggery sheds 3 and 4. All pipelines have been laid at a minimum gradient of 2% to encourage drainage of any condensate towards strategically located drainage points.

1.1.4 Piggery shed heating system

The piggery farrowing sheds (where the lactating sows and their piglets are housed) are heated by circulating hot water through concrete heating pads installed in the floors of the farrowing pens. The water is heated by two Rheem 631265 hot water systems installed between piggery sheds 2 and 3. The original hot water system burnt liquid petroleum gas (LPG) supplied from a 3000 L tank located directly to the north of Shed 1. This tank is periodically refilled by Origin Energy. As part of the on-site research project, a second Rheem 631265 hot water system, originally designed to burn natural gas, was installed adjacent to the LPG unit. An authorised gas fitter was employed to modify the second unit to burn biogas. An electrical control system has been installed to preferentially use the available biogas for water heating, thereby minimising the use of LPG.

Both hot water systems supply heated water to an elevated header tank. An electric circulation pump is used to circulate the hot water from the header tank through the piggery shed heating pads and back to the elevated tank. The thermostat on the biogas fired unit is set at a higher temperature than the thermostat in the LPG unit.

When the biogas supply is depleted and the pressure in the biogas supply line falls below a minimum operating pressure, the biogas system shuts down and the LPG system continues to supply the required hot water.

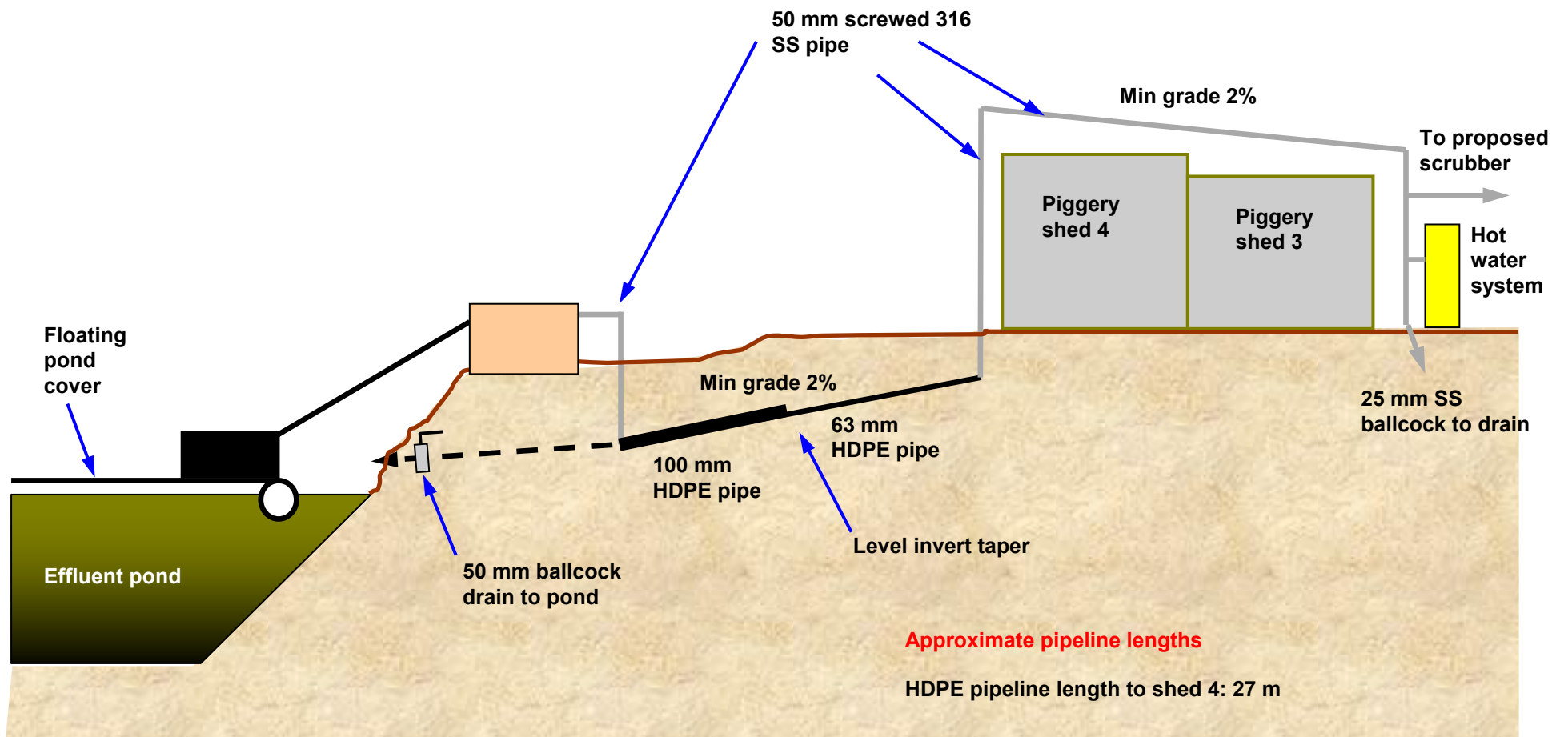

Figure 29. Biogas piping system used to convey biogas from the biogas extraction system to the water heating system.

1.2 Location

As shown in Figure 30, the piggery and biogas system are located in Roses Road, approximately 1 km south-south-west of the town of Grantham, in the Lockyer Valley, South-East Queensland.

Piggery address: [REDACTED]

Piggery real property description: [REDACTED]

The closest residence is located approximately 80 m to the north of the covered pond, on the piggery property. A piggery employee lives at this residence. The next closest residences are located approximately 500 m from the biogas system.

The piggery property is surrounded by rural properties used for commercial grazing and agricultural cropping enterprises. There are also some large rural-residential blocks to the south of the piggery.

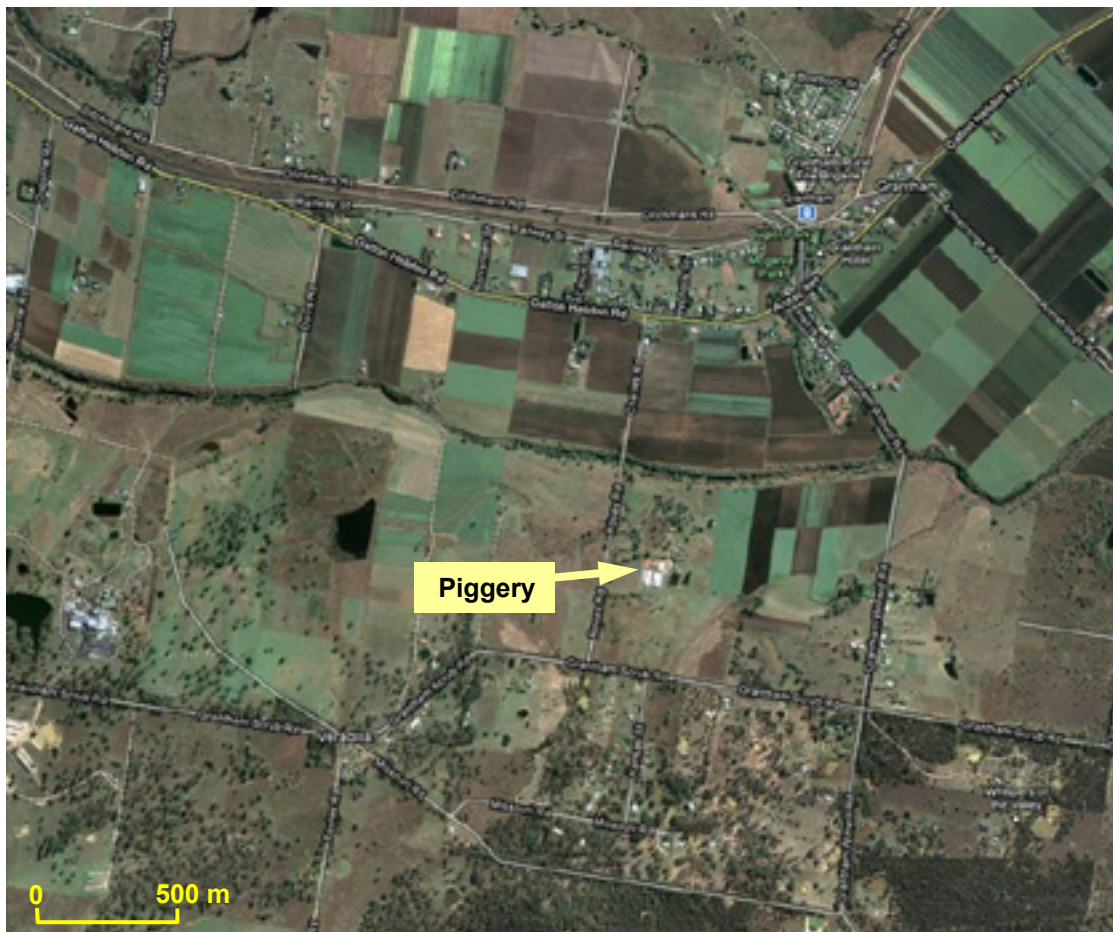

Figure 30. Aerial photograph showing the locality of the piggery and associated biogas collection and use system.

1.3 Operation

1.3.1 Description

The biogas capture and use system is currently jointly operated by Department of Agriculture, Fisheries and Forestry (DAFF Queensland) researchers and piggery employees. The DAFF researchers monitor production and quality of the biogas emitted from the covered pond, in addition to the performance of the biogas water heating unit. This generally involves reading meters and downloading data loggers at regular, weekly to monthly intervals. On completion of the current research project (scheduled for June 2013), ownership and responsibility for managing the biogas system will become the sole responsibility of the piggery owners.

The piggery manager currently observes the condition of the pond cover on a daily basis and opens condensation bleed valves to release any condensate from the gas delivery line. Three permanent staff (including the piggery manager) operate the piggery on a day-to-day basis. Working hours are generally 7:00 AM to 3:00 PM, seven days per week. Additional staff may work at the piggery on a casual basis, to assist with maintenance or facility upgrades. One of the piggery staff resides in the residence situated approximately 80 m north of the covered pond.

1.3.2 Contact details:

1.3.2.1 DAFF (Qld) research staff

Project Leader: Alan Skerman
Principal Environmental Engineer
Telephone 07 4688 1247, Mobile 0407 462 529, Facsimile 07 4688 1192
Email alan.skerman@daff.qld.gov.au

Agri-Science Queensland
Department of Agriculture, Fisheries and Forestry (DAFF Qld)
PO Box 102 (203 Tor Street), Toowoomba, Queensland 4350

1.3.2.2 Piggery management

Piggery owners:

[Redacted]

Joint-Owner:

[Redacted]

Piggery manager:

[Redacted]

2. Organisational safety policies

2.1 DAFF Queensland

Following the recent change in Government and Departmental organisation, organisational safety policies are currently being reviewed and revised, as required. In the interim, all DAFF Queensland employees involved in operating and maintaining the piggery biogas system are required to comply with the Corporate Standard HR 7.002, Workplace Health and Safety (former Department of Primary Industries and Fisheries, 2004). DPI&F also produced a *Safe Work Practices Handbook* which provides more specific guidance on managing common workplace safety risks.

Following organisational changes in 2009, the former Department of Employment, Economic Development and Innovation (DEEDI) produced the following Department-wide Workplace Health and Safety Policy:

DEPARTMENT OF EMPLOYMENT, ECONOMIC DEVELOPMENT AND INNOVATION WORKPLACE HEALTH AND SAFETY POLICY STATEMENT

The Department of Employment, Economic Development and Innovation (DEEDI) is committed to achieving and maintaining a culture that promotes a safe and healthy work environment for employees, clients, visitors and contractors at all its workplaces. When conducting business activities management at all levels within the department will strive for zero injuries by supporting and promoting the spirit and intent of the commitment.

The Department will provide a work environment and conduct its business activities in a manner which:

- protects the health, safety and wellbeing of all employees, contractors, clients and visitors
- promotes safety awareness and safe working practices in the workplace
- supports continual improvements to policies, procedures, guidelines and training that result in better individual and organisational health and safety outcomes
- encourages risk assessment and minimisation in all work practices
- does not compromise health, safety and environmental standards in the community
- provides a system for auditing and reviewing to ensure continual improvements in health, safety and wellbeing performance.

To achieve this commitment all management will:

- comply with, and promote the spirit and intent of, legislation and regulatory instruments
- promote and maintain healthy, safe and environmentally aware work practices
- provide encouragement, support and sufficient resources to Workplace Health and Safety Officers, Workplace Health and Safety Representatives and Rehabilitation and Return to Work Coordinators to enable them to properly undertake their duties
- adopt a consultative approach on all workplace health, safety and wellbeing related issues
- rectify workplace hazards, assess, manage and minimise health and safety risks

- report hazards, incidents, accidents and non-compliance and facilitate effective investigations.

All employees will:

- act in a manner that does not compromise the health, safety and wellbeing of themselves or others
- comply with the spirit and intent of policies, procedures, guidelines, legislation and regulatory instruments
- report all incidents, near hits, injuries and hazards and, as appropriate, take remedial action
- support programs and initiatives that promote improvements in health, safety and wellbeing in the workplace.

**No task is so important that you should place yourself or others at risk.
If is not safe, then you should not undertake the task until it can be done safely.**

Peter Henneken

Director-General

Department of Employment, Economic Development and Innovation

July 2009

2.2 Queensland Natural Pork Holdings (QNPH)

QNPH policy on Workplace Health and Safety to be advised.

3. Organisational structure and safety responsibilities

Figure 31 outlines the relationships between the piggery and research project management.

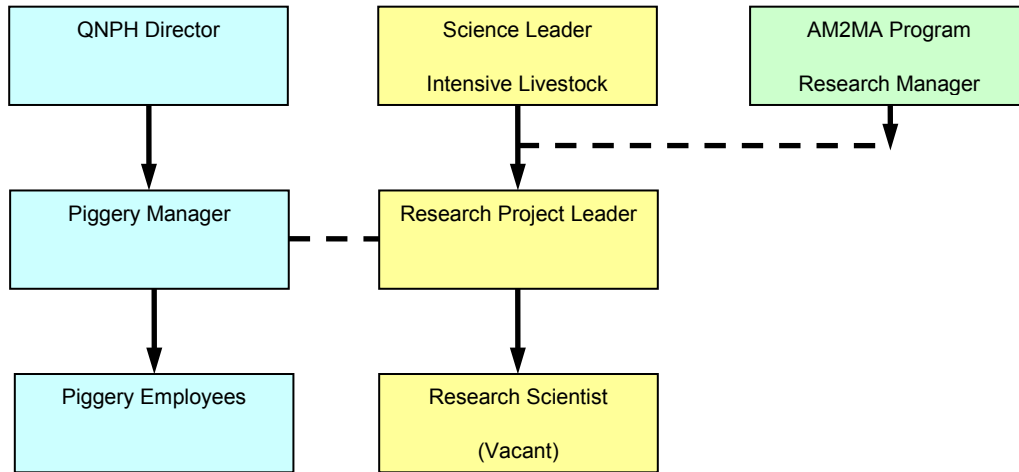

Figure 31. Organisational structure showing current relationships between piggery and research project management.

The designated operator and site safety manager are identified below:

Designated Operator of the Plant (Sec 673):

[Redacted]

[Redacted]

Designated Site Safety Manager (Sec 692):

[Redacted]

The organisational chart provided in Figure 32 outlines the current management structure within the Department of Agriculture, Fisheries and Forestry (DAFF) with regard to delivery of the current research project.

The *Workplace Health and Safety Act 1995* defines the obligations of certain workers according to their position and/or function in the organisation. In accordance with these definitions, the respective responsibilities of various DAFF employees are detailed in Section 1 (Accountabilities and Responsibilities) of the Corporate Standard HR 7.002, Workplace Health and Safety (former Department of Primary Industries and Fisheries, 2004).

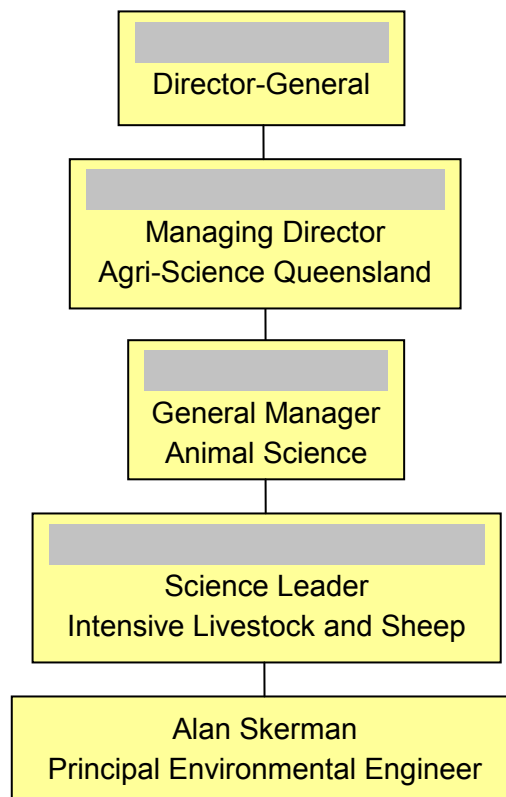

Figure 32. DAFF organisational structure.

4. Plant sites for which a site safety manager is required

The biogas system is unmanned for the majority of the time with scheduled site visits by research project staff to undertake biogas monitoring and sampling, generally on a monthly basis. The piggery manager (site safety manager) observes the condition of the pond cover and biogas system on a daily basis and contacts the research project leader if any anomalies or concerns are identified. It is considered that the size, complexity and relatively low level of hazard associated with the piggery biogas system do not warrant the appointment of a full-time, on-site safety manager.

On behalf of the site safety manager, the research project leader conducts induction sessions for all visitors and contractors entering the site on official business. First aid equipment is available at the piggery office and in all DAFF vehicles visiting the site. Personal protective clothing is used, as required, by piggery and research project staff working at the site.

5. Formal safety assessment

The major potential hazards associated with the biogas system arise due to the presence of methane gas, having the properties outlined in Table 9.

Table 9. Properties of methane gas.

Appearance:	Colourless and odourless
Fire / Explosion hazard:	Flammable gas
Specific gravity:	0.6
Flammability range:	5 – 15%
Auto ignition temperature:	595°C
UN number:	1971

The biogas generated by the anaerobic pond contains approximately 70% methane and 30% carbon dioxide, with possible traces of nitrogen, hydrogen and hydrogen sulphide. Consequently, the composition of the biogas stored under the cover and in the delivery lines is clearly well outside the flammability limits. Because the biogas is lighter than air, it readily disperses under outdoor conditions and has a relatively high ignition point. The biogas pressure under the pond cover has previously been measured at 30 Pa, while the Secomak booster provides a maximum pressure lift of 3.2 kPa.

The maximum volume of biogas that could be stored under the pond cover is estimated to be 750 m³ which represents approximately 10 days of biogas production from the anaerobic pond. The energy value of the maximum volume of stored biogas is estimated to be approximately 17 GJ.

Table 10 outlines the hazards identified for the operation of the biogas system at the Grantham piggery site. A risk assessment of these hazards has been carried out in accordance with the methodology outlined in the Risk Management Code of Practice 2007, Supplement 2 – Risk assessment (Workplace Health and Safety Queensland, Rev 2008). In this methodology, a 'likelihood' and 'consequence' are assigned to each of the hazards. These two factors are combined to determine a quantitative risk priority, as outlined in Figure 33. Figure 34 outlines the recommended actions for each of the risk scores.

Table 10 lists control measures implemented to reduce the risks to acceptable levels.

Likelihood How likely is it to happen?	Consequences: How severely it hurts someone (if it happens)?				
	Insignificant (no injuries)	Minor (first aid treatment only; spillage contained at site)	Moderate (medical treatment; spillage contained but with outside help)	Major (extensive injuries; loss of production)	Catastrophic (death; toxic release of chemicals)
Almost certain - expected in most circumstances	3 H	3 H	4 A	4 A	4 A
Likely - will probably occur in most circumstances	2 M	3 H	3 H	4 A	4 A
Possible - might occur at some time	1 L	2 M	3 H	4 A	4 A
Unlikely - could occur at some time	1 L	1 L	2 M	3 H	4 A
Rare - may occur, only in exceptional circumstances	1 L	1 L	2 M	3 H	3 H

Figure 33. Risk priority chart (WHS Qld, 2008).

Score and statement	Action
4 A: Acute	ACT NOW - Urgent - do something about the risks immediately. Requires immediate attention.
3 H: High	Highest management decision is required urgently.
2 M: Moderate	Follow management instructions.
1 L: Low	OK for now. Record and review if any equipment, people, materials, work methods or procedures change.

Figure 34. Risk scores and actions (WHS Qld, 2008).

Table 10. Hazard assessment table.

No.	Hazard description	Causes	Likelihood <i>How likely is it to happen?</i>	Consequence <i>How severely could it hurt someone?</i>	Initial risk score	Control measures implemented <i>- to reduce risk to an acceptable level</i>
1	Biogas Explosion	<ol style="list-style-type: none"> 1. Methane-air mixture ratio 2. Ignition source 3. Limited dispersion of leaked biogas 	Unlikely	Major	High	<ul style="list-style-type: none"> • Biogas system components installed in an outdoor location allowing effective dispersion of any leaked biogas. • Restrict potential ignition sources from the general vicinity of the biogas system. • Restrict site access and erect appropriate warning signs. • Ensure that all equipment used in hazardous zones near the biogas system has an appropriate hazard rating. • Forward feed relief regulator on the flare line prevents air being sucked into the pond cover in the event of a negative pressure. • Flame arresters installed in biogas management system to prevent flash back to pond cover. • Low gas pressure switch shuts down the booster pump if the inlet pressure drops below 0.1 mbar. • Regularly check gas management system for leaks. • All gas and electrical components installed, tested and approved by licensed contractors in accordance with relevant Australian Standards. • All biogas components serviced on a six-monthly basis by an authorised gas fitter.

No.	Hazard description	Causes	Likelihood <i>How likely is it to happen?</i>	Consequence <i>How severely could it hurt someone?</i>	Initial risk score	Control measures implemented <i>- to reduce risk to an acceptable level</i>
2	Biogas Jet fire	1. Pipe, seal or gasket failure 2. Ignition source	Rare	Major	High	<ul style="list-style-type: none"> • System operates at relatively low pressure. • Restrict potential ignition sources from the general vicinity of the biogas system. • Ensure that all equipment used in hazardous zones near the biogas management system has an appropriate hazard rating. • Regularly check gas management system for leaks. • All gas and electrical components installed, tested and approved by licensed contractors in accordance with relevant Australian Standards. • All biogas components serviced on a six-monthly basis by an authorised gas fitter.

No.	Hazard description	Causes	Likelihood <i>How likely is it to happen?</i>	Consequence <i>How severely could it hurt someone?</i>	Initial risk score	Control measures implemented <i>- to reduce risk to an acceptable level</i>
3	Biogas Fireball - delayed ignition	<ol style="list-style-type: none"> 1. Pipe, seal or gasket failure 2. Ignition source 3. Limited dispersion of leaked biogas 	Unlikely	Major	High	<ul style="list-style-type: none"> • Biogas system is located in an elevated, outdoor location with good atmospheric dispersion characteristics. • Restrict potential ignition sources from the general vicinity of the biogas system. • Ensure that all equipment used in hazardous zones near the biogas management system has an appropriate hazard rating. • Regularly check gas management system for leaks. • All gas and electrical components installed, tested and approved by licensed contractors in accordance with relevant Australian Standards. • All biogas components serviced on a six-monthly basis by an authorised gas fitter.
4	Release of uncombusted biogas	<ol style="list-style-type: none"> 1. Flare ignition failure 	Possible	Insignificant	Low	<ul style="list-style-type: none"> • Solar flare provides continuous ignition sparks at 1.5 second intervals • CF-5 Landfill flare expected to give 98% combustion efficiency under passive inlet pressure conditions.
5	Grass fire	<ol style="list-style-type: none"> 1. Failure to maintain grass around pond. 2. Ignition source. 3. Dry climatic conditions. 	Possible	Moderate	High	<ul style="list-style-type: none"> • Maintain grass/vegetation surrounding the effluent pond and biogas system in a short condition by regular mowing and/or application of herbicide. • Fire fighting hoses are available in nearby piggery sheds

No.	Hazard description	Causes	Likelihood <i>How likely is it to happen?</i>	Consequence <i>How severely could it hurt someone?</i>	Initial risk score	Control measures implemented <i>- to reduce risk to an acceptable level</i>
6	Asphyxiation	1. Inhalation of concentrated biogas containing hydrogen sulphide.	Rare	Catastrophic <ul style="list-style-type: none"> • 530–1000 ppm: breathing problems • 800 ppm lethal concentration for 50% of humans (5 min exposure) • > 1000 ppm immediate collapse 	High	<ul style="list-style-type: none"> • Biogas hydrogen sulphide (H₂S) level measured at 1000 - 3000 ppm. • Biogas system located in well ventilated, outdoor location. • Restrict site access and erect appropriate warning signs.
7	Drowning in effluent pond	1. Tripping while carrying out work. 2. Unauthorised entry	Unlikely	Moderate	Moderate	<ul style="list-style-type: none"> • Restrict site access and erect appropriate warning signs. • Wear life jacket when working in close proximity to effluent pond and cover.

The piggery property is operated under strict biosecurity protocols and is fully fenced with standard rural barbed wire fencing. The piggery and biogas system are serviced by a single vehicular entrance from a driveway off Roses Road. Signage is erected at this entrance prohibiting access by any visitors unless they are on official business and meet strict quarantine conditions (no contact with pigs during preceding 72 hour period, and freshly laundered clothing and clean boots). Unauthorised access to the biogas system could be gained from adjoining rural properties by crossing barbed-wire fences. The biosecurity protocols which are strictly enforced by piggery management, limit the risk of unauthorised entry onto the property and access to the biogas system.

Classification of areas (explosive gas atmospheres)

Areas surrounding the biogas train in which an explosive gas atmosphere could be expected (due to leakage of biogas) are designated as hazardous areas in accordance with Clause 8.1 of Annex ZA of AS/NZS 60079.10.1:2009 (Landfill gas, sewerage treatment and sewerage pumping plants). This Clause specifically refers to methane generated by biodigestion of farm wastes and is therefore applicable in this case.

Points of potential biogas leakage include valves, pipe joints, flanges, gas meters, regulators, water traps and gas boosters. Because the biogas system is located outdoors (in the open air), these areas are considered to be adequately ventilated, with a maximum biogas system operating pressure of 3.2 kPa. Consequently, all of these areas, within spheres extending 0.25 m from the point of potential leakage, are classified as Zone 2 (areas in which an explosive gas atmosphere is not likely to occur in normal operation but, if it does occur, it will exist for a short period only). The biogas flare is considered to be a vent having a 3 m radius Zone 2 sphere surrounding the discharge point.

All equipment constructed, installed or operated within these zones must comply with the relevant explosion protection rating. Appropriate warning signs have been erected adjacent to these areas.

6. Interaction with other operating plant or contractors

The piggery is currently supplied with LPG by Origin Energy. Deliveries to the piggery are made at approximately monthly intervals. The 3000 L capacity LPG storage tank is located approximately 85 m to the west of the biogas system. Origin Energy employees have no interaction with the biogas system.

7. Skills assessment

The biogas system is designed to operate automatically, with minimal operator input. A number of research tasks are undertaken on a regular basis in the vicinity of the biogas system. These tasks include monitoring biogas production and quality. Other routine tasks

include monitoring the system operation, checking for leaks, releasing any accumulated condensate from the biogas lines, and coordinating any maintenance carried out by licensed electricians and/or gas installers. Table 11 outlines these tasks along with the responsible person, skills required and training.

Table 11. Responsibilities, skills and training required to carry out research and operational tasks in the vicinity of the biogas system.

No	Task	Person responsible	Skills required	Training
1	Monitor biogas quality using Geotech® portable biogas analyser	Technical officers, Project leader	Basic knowledge of system operation and potential hazards	On-site training provided by Project Leader
2	Release condensate from biogas system	Piggery manager, Technical officers, Project leader	Basic knowledge of system operation and potential hazards	On-site training provided by Project Leader
3	Check system operation	Piggery manager, Technical officers, Project leader	Thorough knowledge of system operation and potential hazards	Familiarity with equipment operating manuals and on-site training provided by Project leader
4	Check for biogas leaks	Piggery manager, Technical officers, Project leader	Basic knowledge of system operation and potential hazards	On-site training provided by Project leader
5	Read biogas meter and download data logger.	Piggery manager, Technical officers, Project leader	Basic knowledge of system operation and potential hazards	On-site training provided by Project leader
6	Diagnose and rectify electrical faults	Licensed electrical contractor	Statutory requirement	Trade qualifications
7	Service biogas system components	Gas installer authorised for Type B gas installations	Statutory requirement	Trade qualifications
8	Upgrading and/or replacement of biogas system valves, pipe work and/or other system components.	Gas installer authorised for Type B gas installations	Statutory requirement	Trade qualifications

8. Training and supervision program

Following installation of the biogas management system, the authorised type B gas fitter responsible for fabricating and installing the system provided on-site training to the piggery manager, research project leader and technical officer on operation and maintenance of the system.

Subsequent on-site training of all DAFF and piggery staff who are required to work in the vicinity of the biogas system will be provided by the piggery manager or the research project leader, giving due consideration to hazards and consequences of incorrect procedures and emergency provisions.

9. Safety standards and standard operating procedures

The biogas management system has been designed and installed in accordance with the standards listed in Schedule 1 of the *Petroleum and Gas (Production and Safety) Regulation 2004* and/or industry best practice, by an experienced contractor authorised to carry out type B gas installations.

The relevant standards include the following:

Column 1 Name of code, standard or document	Column 2 What the safety requirement applies to	Column 3 Mandatory or preferred standard
AS 2885 'Pipelines—gas and liquid petroleum' Part 1 'Design and construction' (2007) Part 2 'Welding' (2007) Part 3 'Operation and maintenance' (2001) Part 4 'Offshore submarine pipeline systems' (2003) Part 5 'Field pressure testing' (2002)	design, construction, operation and maintenance of transmission pipelines	mandatory

AS 1697 'Installation and maintenance of steel pipe systems for gas' (2005)	design and construction of high pressure distribution systems	preferred
AS 2033 'Installation of polyethylene pipe systems' (1980)	installation of distribution systems	preferred
AS/NZS 2648.1 'Underground marking tape—non-detectable tape' (1995)	installation of buried distribution systems and consumer pipes	preferred
AS 3723 'Installation and maintenance of plastics pipe systems for gas' (1989)	installation and maintenance of distribution systems	preferred
AS 4041 'Pressure piping' (2006)	installation of distribution pipelines, facilities and consumer piping	preferred
AS/NZS 4129 'Fittings for polyethylene (PE) pipes for pressure applications' (2000)	installation of distribution systems	preferred
AS 4645 'Gas distribution network management' (2005)	distribution of LPG vapour and natural gas	preferred
AS 3814 'Industrial and commercial gas-fired appliances' (2005)	design and certification of gas devices (type B)	preferred
AS 5601 / AG 601 'Gas installations' (2004)	installation of gas systems	preferred

Column 1 Name of code, standard or document	Column 2 What the safety requirement applies to	Column 3 Mandatory or preferred standard
AS 61508 'Functional safety of electrical / electronic / programmable electronic safety-related systems' Part 0 'Functional safety and AS61508' (2006) Part 1 'General requirements' (1999) Part 2 'Requirements for electrical / electronic / programmable electronic safety-related systems' (2001) Part 3 'Software requirements' (1999) Part 4 'Definition and abbreviations' (1999) Part 5 'Examples of methods for the determination of safety integrity levels' (1999) Part 6 'Guidelines on the application of AS 61508.2 and AS 61508.3' (2001) Part 7 'Overview of techniques and measures' (2001)	installation and operation of gas systems	preferred

AS/IEC 61511 'Functional safety—safety instrumented systems for the process industry sector' Part 1 'Framework, definitions, systems, hardware and software requirements' (2004) Part 2 'Guidelines for the application of AS/IEC 61511—1' (2004) Part 3 'Guidance for the determination of the required safety integrity levels' (2004)	installation and operation of gas systems	preferred
AS 2430.3 'Classification of hazardous areas—examples of area classification' Part 1 'General' (2004) Part 4 'Flammable gases' (2004) Part 7 'Landfill gas, sewage treatment and sewage pumping plants' (2004)	assessing the hazardous nature of a gas system for fuel gas or petroleum	preferred
AS/NZS 2865 'Safe working in a confined space' (2006)	work carried out in a confined space	preferred
AS/NZS 60079 'Electrical apparatus for explosive gas atmospheres' Part 10 'Classification of hazardous areas' (2004)	design of a gas system for fuel gas or petroleum	preferred

Following commissioning of the biogas collection and use system, standard operating procedures are being developed for all work carried out in the vicinity of the biogas system.

10. Control systems

The biogas system is designed to operate as follows. (Refer to Figure 28 and Table 1 for system component identification):

- Hot water system (HWS - 17) calls for heat. (Signal out to master control.)
- The normally open (N/O) spring return air actuated valve (4) closes, isolating the flare (7) and the closed position proving (CPP) limit switch (refer to electrical schematic – Fig 2) makes.
- Provided the CPP and the low gas pressure switch (PSL - 8) are both made, the booster (10) will start.
- The booster (10) outlet pressure is controlled by the forward feed relief regulator (11).

- The reticulation pipeline pressure is controlled by the supply regulator (12).
- Provided the high gas pressure switch (PSH - 13) proves there is adequate gas pressure in the supply to the HWS (17), the HWS (17) will be enabled and will fire up.
- When the water heater (17) reaches the temperature set on the thermostat and no longer calls for heat, the signal will be lost and the master control (CPP) will shut down the system, and the flare isolation valve (4) will open.
- As pressure builds in the system the flare forward feed relief regulator (5) will allow gas to pass to the flare maintaining some pressure in the system.
- When the booster (10) is running, if the inlet gas pressure drops to less than 0.1 mbar (0.010 kPa) as measured at the PSL (8), the switch will open and the booster (10) will stop, preventing air being sucked into the system.
- As pressure in the outlet system drops, the PSH (13) will turn off the HWS (17) before all gas pressure in the reticulation line is lost. The gas reticulation pipe work will act as a buffer, providing some line pack.

The purpose of timer (T1) is to provide a delay for the booster operation. If the supply pressure drops below the pressure switch set point the booster will stop, protecting the supply. The inlet pressure will in all probability immediately bounce back up and restart the booster. In effect the booster will hunt (stop and start) and possibly burn out the motor. The timer will provide a delayed booster start to allow the pond to regenerate gas and the system to run for some time. The timer final setting will depend upon the load applied to the system relative to the gas generated and will need to be field adjusted to suit. It is expected that the timer setting may be in a range from 10 to 60 minutes.

11. Machinery and equipment relating to safety

The authorised type B gas installer employed to install, commission, test and certify the biogas management system identified all critical safety equipment included in the system and provided training to the research project leader and piggery manager with regard to any relevant operational, testing or maintenance requirements to ensure the ongoing safe operation of the system.

The manufacturer's operating manuals are also consulted in determining appropriate operation and maintenance procedures.

12. Emergency equipment preparedness and procedures

The piggery biogas system is essentially unmanned. It has been designed to operate automatically with minimal operator intervention, other than routine checks and scheduled maintenance, in accordance with the equipment manufacturers' and or installers' recommendations. The covered pond and biogas system are located approximately 30 m to the east of the nearest piggery shed where pigs are housed and piggery staff work intermittently. Consequently, it is unlikely that piggery staff would be immediately directly affected by an explosion or fire originating from the covered pond or associated management system. Similarly, occupants of the nearest residence which is located approximately 80 m north of the biogas system, are unlikely to be directly affected by a biogas explosion or fire.

In the event of a grass fire, piggery staff would use an existing fire-fighting pump or piggery shed wash-down hoses to extinguish the fire. DAFF research staff would be notified of the incident.

In the event of an explosion or fireball, piggery staff would immediately notify Emergency Services before notifying DAFF research staff. It is understood that the Petroleum and Gas Inspectorate would be notified by Emergency Services in the event of an emergency. The piggery manager would be responsible for evacuating and accounting for all piggery workers and any contractors or visitors on the site. The evacuation assembly point is located on the western side of the piggery, at least 60 m from the biogas system. All piggery workers, contractors and visitors would be instructed to remain at the assembly point until advised by Emergency Services Officers that it is safe to re-enter the piggery.

Plans of the biogas system and estimates of the production rate, likely storage volume, storage pressure, composition and energy value of the biogas will be kept in the piggery office for referral to Emergency Services personnel, in the event of a major incident.

13. Communication systems

The piggery manager would be the most likely person to identify an emergency situation. Consequently, he would be responsible for contacting the following people / organisations, in decreasing order of priority, on the phone numbers provided.

- | | | |
|----|---|--------------|
| 1. | Emergency Services
(For GSM mobile phones outside provider's coverage area) | 000
112 |
| 2. | Piggery manager - [REDACTED] | [REDACTED] |
| 3. | Petroleum and gas inspectorate (Resources and Energy)
24 hour gas emergency phone contact number | 0419 888 575 |

Email: gassafe@dme.qld.gov.au

- | | | |
|----|---|--|
| 4. | Agri-Science Queensland (DAFF) research project manager
Alan Skerman | 07 4688 1247 office
0407 462 529 mobile
07 4633 1505 A/H |
| 5. | Piggery owners
[REDACTED]
[REDACTED] | [REDACTED]
[REDACTED] |

14. Mechanism for implementing, monitoring, reviewing and auditing safety policies and safety management plans

This safety management plan has been implemented following the installation and commissioning of the biogas management system. The authorised type B gas installer employed to carry out the installation has provided training on system operation and emergency procedures to relevant research and piggery staff.

Unless any incidents occur earlier, the safety management plan will be reviewed initially after the system has been operating for a period of 6 months. Following the initial review, the plan will be updated as necessary, annually, or following any incidents or significant changes to the system.

15. Key performance indicators

Any incidents or injuries sustained by personnel working in the vicinity of the biogas system will be recorded and investigated.

16. Mechanisms for investigating, recording and reviewing incidents at the plant

In consultation with the piggery manager, the research project leader will use the Incident Cause Analysis Method (ICAM) (or similar) to investigate any incidents that either did, or could possibly have resulted in death, injury, property damage, fire, gas leak, illness or disease, in relation to the operation of the biogas system. A report will be prepared outlining

the findings of the investigation. Depending on the scale or scope of the investigation, an experienced external consultant may be employed to carry out and report on the incident investigation.

17. Record management

The master copy of this Safety Management Plan will be kept at the piggery office, along with all approvals, authorisations, certificates of compliance, licences and compliance directions. Standard work procedures (SWPs) and standard operating procedures (SOPs) will also be developed and held on-site at the piggery. Copies of each of these documents will be kept by the DAFF research project leader, in the Toowoomba office (203 Tor Street).

18. Application of the Workplace Health and Safety Act 1995

Not applicable

19. Major hazard facilities

Not applicable

20. Additional risks

Not applicable – no drilling operations

21. Additional legislative obligations

Copies of this Safety Management Plan are readily available to all DAFF research staff and piggery staff who may undertake work in the vicinity of the biogas system.

Standard operating plans will be developed following commissioning of the biogas system. These plans will be readily available to all DAFF research staff and piggery staff who may undertake work in the vicinity of the biogas system.

The biogas system has been designed by an experienced contractor, in accordance with relevant mandatory and preferred standards.

The installer of the upgraded biogas system will be operating under the required authorisation issued by an authorised type B gas approval authority.

All DAFF research staff and piggery staff who may undertake work in the vicinity of the biogas system will be informed of their obligations under the Act in relation to keeping risk to an acceptable level, complying with this Safety Management Plan, complying with lawful instructions and carrying out wilful acts or omissions that affect safety at the site.

Methane Recovery and use at Grantham Piggery

By Alan Skerman and Gary Collman

Pub. No. 12/O64

This project involved upgrading the biogas extraction system originally installed in conjunction with a partial floating cover, retro-fitted to the primary anaerobic pond at the QNPH Grantham piggery. Following the system upgrade, this project also included installing a biogas reticulation pipeline to supply biogas from the extraction system, to a water heating system used to heat water circulated through underfloor heating pads in the piggery farrowing sheds.

This biogas fired water heating system has the potential to significantly reduce on-farm energy costs by replacing a significant proportion of the Liquid Petroleum Gas (LPG) previously used for farrowing shed heating.

RIRDC is a partnership between government and industry to invest in R&D for more productive and sustainable rural industries. We invest in new and emerging rural industries, a suite of established rural industries and national rural issues.

Most of the information we produce can be downloaded for free or purchased from our website <www.rirdc.gov.au>.

RIRDC books can also be purchased by phoning 1300 634 313 for a local call fee.



RURAL INDUSTRIES

Research & Development Corporation

Phone: 02 6271 4100

Fax: 02 6271 4199

Bookshop: 1300 634 313

Email: rirdc@rirdc.gov.au

Postal Address: PO Box 4776,
Kingston ACT 2604

Street Address: Level 2, 15 National Circuit,
Barton ACT 2600

www.rirdc.gov.au

Cover image: Biogas extraction system installed adjacent to the north-western corner of the primary effluent pond