

Sweet corn information kit

Reprint – information current in 2005



REPRINT INFORMATION – PLEASE READ!

For updated information please call 13 25 23 or visit the website www.deedi.qld.gov.au

This publication has been reprinted as a digital book without any changes to the content published in 2005. We advise readers to take particular note of the areas most likely to be out-of-date and so requiring further research:

- Chemical recommendations—check with an agronomist or Infopest www.infopest.qld.gov.au
- Financial information—costs and returns listed in this publication are out of date. Please contact an adviser or industry body to assist with identifying more current figures.
- Varieties—new varieties are likely to be available and some older varieties may no longer be recommended. Check with an agronomist, call the Business Information Centre on 13 25 23, visit our website www.deedi.qld.gov.au or contact the industry body.
- Contacts—many of the contact details may have changed and there could be several new contacts available. The industry organisation may be able to assist you to find the information or services you require.
- Organisation names—most government agencies referred to in this publication have had name changes. Contact the Business Information Centre on 13 25 23 or the industry organisation to find out the current name and contact details for these agencies.
- Additional information—many other sources of information are now available for each crop. Contact an agronomist, Business Information Centre on 13 25 23 or the industry organisation for other suggested reading.

Even with these limitations we believe this information kit provides important and valuable information for intending and existing growers.

This publication was last revised in 2005. The information is not current and the accuracy of the information cannot be guaranteed by the State of Queensland.

This information has been made available to assist users to identify issues involved in sweet corn production. This information is not to be used or relied upon by users for any purpose which may expose the user or any other person to loss or damage. Users should conduct their own inquiries and rely on their own independent professional advice.

While every care has been taken in preparing this publication, the State of Queensland accepts no responsibility for decisions or actions taken as a result of any data, information, statement or advice, expressed or implied, contained in this publication.



Queensland Government



Growing the CROP

This chapter is our summary for growing and marketing a commercial crop of sweet corn. To keep the chapter as brief as possible and easy to follow, we provide little explanation with recommendations. Where more information may help, we refer you to other sections of the book. Symbols on the left of the page will help you make these links.

Getting the crop started 27

When to plant 27, Select varieties 29, Seed requirements/order 30, Choose an irrigation system 32, Prepare land 34, Lay out field 39, Apply fertiliser 41, Control weeds 44, Plant 45, Irrigate 46

Planting to tasselling 48

Monitor soil moisture/irrigate 48, Manage pests and diseases 51, Control weeds 56, Manage plant nutrition 57

Tasselling to end of silking 63

Monitor soil moisture and irrigate 63, Manage pests and diseases 64, Control weeds 64, Manage plant nutrition 64, Pollination 65

End of silking to harvest 66

Monitor soil moisture and irrigate 66, Manage pests and diseases 67, Control weeds 67

Harvesting, marketing, handling 68

Harvesting 68, Postharvest handling 71, Grading and packing 71, Packaging 73, Mark packages 74, Cooling 75, Transport 75, Storage 76, Marketing 77

The sweet corn plant



Figure 6. Parts of the sweet corn plant

tassel

leaf

internode

node

cob

ear leaf

stalk

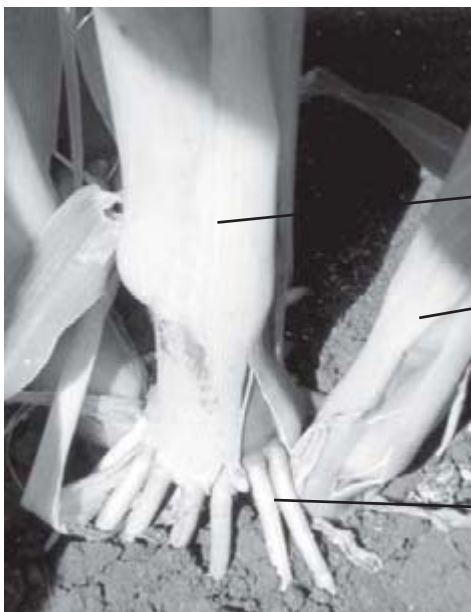

main stem

tiller

prop roots

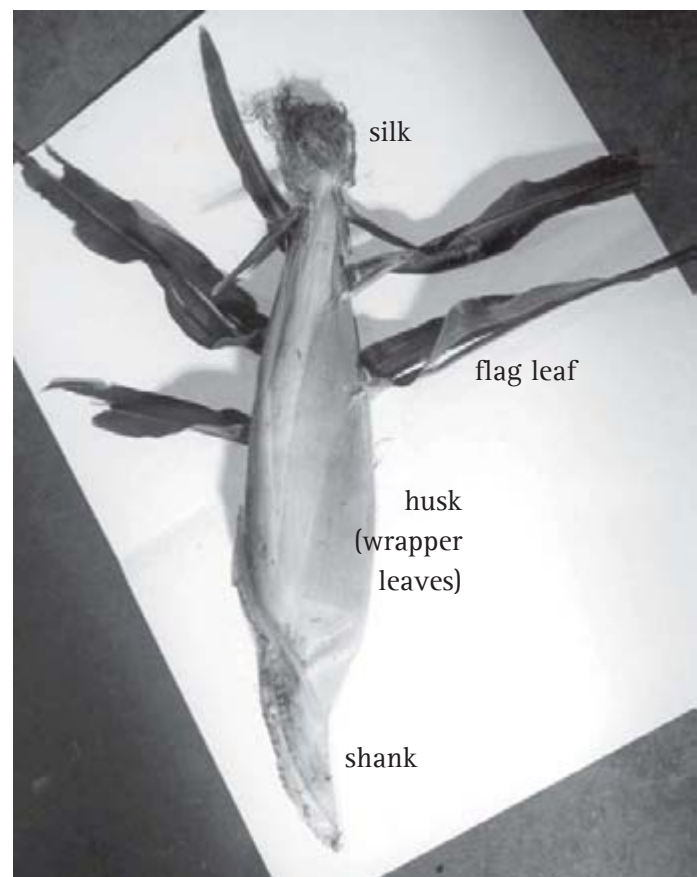

silk

flag leaf

husk
(wrapper
leaves)

shank



Getting the crop started

To give yourself the best chance of success, you need to start planning your crop and preparing the land at least three months before planting. This involves 10 key steps.

Decide when to plant

Select varieties

Work out how much seed you need and order

Choose an irrigation system

Prepare the land

Lay out the field

Apply fertiliser

Control weeds

Plant

Irrigate

Decide when to plant

To maintain an even supply of product to the fresh market, most growers make consecutive plantings, either weekly or several times a week during the planting season. The size of the planting must be geared to the capacity of the shed to cool and pack the cobs and meet the demands of their market. Processors schedule plantings to suit factory operations and district climates.

Recommended times

Planting times are generally dictated by climatic conditions, for example soil temperature, risk of frost or hot, dry conditions and also expected risk periods for heliothis. Table 11 shows the planting and harvesting times for sweet corn in Australia.

Temperature

Sweet corn is sensitive to frost and prefers warm weather. Optimum temperature for growth is 24° to 30°C; no growth occurs below 10°C.

Soil temperature above 14°C is essential for germination of supersweet varieties and temperatures above 18°C are necessary for good germination of supersweet varieties. Normal sweet corn will germinate at soil temperatures above 12°C. Cool or wet conditions will slow germination and increase the chances of seed rots, poor emergence and uneven plant stands.

Other climatic effects

Poor cob fill can occur if rain coincides with pollination. A combination of heavy rain and wind causes lodging, making spraying and harvesting difficult.

Pollination will be poor if hot (above 35°C), dry and windy conditions occur at silking. Poor pollination causes missing kernels or blanks, which often result in poor tip fill.

Table 11. Main planting and harvesting times for sweet corn in Australia

State	District	Plant	Harvest
QLD	Dry tropics	early March – late August	mid May – early November
	Bundaberg	January – April mid July – mid September	April – July October – December
	Southern Queensland	early August – late February	early November – mid June
NSW	Sydney Basin	August – late February	November – early June
	Central West: Dubbo – Narromine	late September – early January	late December – early May
	Cowra	late October – early January	late January – early May
	Bathurst	mid November – late December	mid February – late March
	Riverina	mid September – early January	late December – late April
VIC	East Gippsland	late September – late January	late December – May
	Northern Victoria	early September – December	late December – April/May
	Southern Victoria	early October – January	late January – April/May
TAS	Northern Tasmania	late October – November	mid February – April
SA	Riverland	September – February	December – May
WA	Metropolitan	mid August – mid March	December – June
	Harvey, Bunbury, Busselton	mid September – early February	mid December – late May
	Manjimup, Albany	November – January	mid January – mid May
	Carnarvon	February – May August – September	July – October mid November – January
	Kununurra	April – early September	early July – late October

Crop cycle

Depending on the variety and the time of year that it is planted, a sweet corn crop can take from 60 to 120 days from planting to harvest with most crops maturing between 80 and 95 days.

The time from emergence to tasselling is the most variable stage, and the most influenced by variety and temperature. Table 12 shows the normal time range for each stage of plant growth. The short intervals occur in the hotter weather while each stage takes longer in cool conditions. The very end of the season takes longer in southern districts because maturity slows down significantly.

Table 12. Time range for each growth stage

Plant stage	Time
Sowing to emergence	5 – 15 days
Emergence to tasselling	30 – 50 days
Tasselling to end of silking	13 – 20 days
End of silking to harvest	12 – 18 days
Total	60 – 103 days

Select varieties

Variety (cultivar) selection is an important decision as no single variety performs best across all planting seasons and production techniques. Factors to consider include market requirements, yield, disease resistance, suitability for harvesting and processing machinery and procedures, and the climatic stresses during the production period.

Goldensweet is the main variety grown but is most likely to be replaced with Golden Sweet Improved which has better disease resistance and husk cover. Other varieties include Gladiator, Hybrix 5, Lancaster, Kahuna, Krispy King, Matador and Sovereign.

Early maturing. Krispy King, Rising Sun.

Mid maturing. Gladiator, Golden Sweet Improved, Goldensweet, Kahuna, Lancaster, Sovereign.

Mid to late maturing. Matador.

Late tropical. Hybrix 5 is best suited to the warmer conditions.

Processing sweet corn varieties are determined by the processors and may be standard or normal (su) varieties or supersweet (shrunken 2 [sh₂]) varieties, depending on the processors requirements.

Supersweet varieties must be planted at least 200 m upwind from other types of corn, including normal sweet corn varieties and maize, so keep this in mind when planning your planting schedule. Sh₂ varieties pollinated by su corn will produce cobs with su kernels. To avoid cross-pollination, allow a planting gap between supersweet varieties and normal sweet corn and maize of 14 to 21 days.

Baby corn production is very labour intensive. It is important to select the best variety to grow. Factors to consider include high cob numbers, disease resistance, high yields, good row arrangement of kernels and a strong yellow cob colour. Usually popcorn varieties are used because they produce multiple cobs per plant.



Varieties
Chapter 4 page 135

Determine seed requirements and order

Row width and plant spacing

Row spacing will be determined by the harvesting equipment and cannot be easily changed. Rows are commonly 75 cm apart with 20 to 25 cm between plants in the row.

Deciding how many seeds you need

Sweet corn seed is normally sown at 50 000 to 61 000 seeds per hectare, to give a final plant stand (assuming 90% germination), of about 45 000 to 55 000 plants. For processing crops in NSW the aim is to have 60 000 plants per hectare, so plant approximately 66 700 seeds per hectare.

Seed germination percentage, soil and weather conditions, for example temperature, all affect seed germination and emergence. In the following calculations we are assuming a non-emergence rate of 10%, however it may be more or less than this.

Excluding headlands, the number of seeds required per hectare (10 000 m²) is determined by:

- the distance in metres between the rows (A);
- the distance in metres between seeds in the row (B).

To determine the number of seeds per hectare use the following formula:

$$(10\ 000 \div A) \div B$$

For example: How many seeds will you need at 0.75 m rows (A) and 25 cm (0.25 m) between plants in the row (B)?

$$10\ 000 \div 0.75 = 13\ 333 \div 0.25 = 53\ 333 \text{ seeds per hectare}$$

To determine the number of plants this will give you, allowing for a 10% loss, multiply this figure by 0.9

$$\text{For example: } 53\ 333 \times 0.9 = 48\ 000 \text{ plants per hectare}$$

Table 13 shows our calculations for the numbers of seeds planted per hectare at various row widths and seed spacings, and the number of plants per hectare allowing for an average non-emergence of 10%.

Table 13. Number of seed sown and plants per hectare at different spacings, assuming 10% non-emergence

Distance between plants	Distance between rows									
	1 m		95 cm		90 cm		75 cm		50 cm	
	Seed	Plants	Seed	Plants	Seed	Plants	Seed	Plants	Seed	Plants
15 cm	66 667	60 000	70 175	63 158	74 074	66 667	88 889	80 000	133 333	120 000
17.5 cm	57 143	51 429	60 150	54 135	63 492	57 143	76 190	68 571	114 286	102 857
20 cm	50 000	45 000	52 632	47 369	55 556	50 000	66 667	60 000	100 000	90 000
22.5 cm	44 444	40 000	46 784	42 105	49 383	44 444	59 259	53 333	88 889	80 000
25 cm	40 000	36 000	42 105	37 895	44 444	40 000	53 333	48 000	80 000	72 000
27.5 cm	36 364	32 727	38 278	34 450	40 404	36 364	48 485	43 636	72 727	65 455
30 cm	33 333	30 000	35 088	31 579	37 037	33 333	44 444	40 000	66 667	60 000

Note: The lightly shaded area shows the final plant stands in the 45 000 to 60 000 plants per hectare range and the required seeding rates. The length of rows and the size of headlands will determine what area is required to plant one hectare of actual crop.

Order seed

Purchase seed from a reputable seed supplier. It should be free of disease, have a recent minimum germination percentage attached and have a chemical seed dressing applied.

Contact seed suppliers for details of what varieties they have, when they will be available and the price and delivery arrangements. Do this at least three months before your proposed planting date, or better still, when you are planning your planting schedule before the season starts. Ordering early gives you the best chance of getting the varieties you want when you want them.

Approximately 8 to 10 kg/ha of seed will be required for a planting with rows 0.75 m apart and plants 20 to 25 cm, however this can vary considerably.

Seed size varies considerably, so the number of seeds per kilogram can range from about 4 200 to 11 500 seeds. The size depends on variety and the seed size grade of a particular batch. Because of this wide variation in size it is best to order seed by count rather than weight. Remember that not every seed will germinate, so take note of the germination percentage on the pack of seed you are buying.

Germination percentage and soil and weather conditions will influence plant emergence. Under adverse conditions more seed will need to be planted to achieve a uniform plant stand.



Seed suppliers
Chapter 5 page 241

Choose an irrigation system

Sweet corn has a high water requirement, particularly from tasselling to harvesting.

Leaf rolling indicates a water shortage in the plant. Leaf rolling can also be induced by high temperatures when the plant is having difficulty taking up enough water. This is sometimes called 'pineappleing' because the leaf rolling symptom gives sweet corn an appearance similar to the top of a pineapple. Non-irrigated or poorly irrigated plantings produce smaller plants with poorly filled cobs.

Water use should be monitored, for example with tensiometers or capacitance probes, for the most efficient water management.

Consult an irrigation specialist, equipment supplier or designer in your area to develop an irrigation plan for your farm.

a key issue



Irrigation and water management
Chapter 4 page 154

Methods of irrigation

Overhead, drip and furrow irrigation are all used.

Overhead irrigation includes fixed and travelling irrigators (single jets and booms) and sprinklers including hand move, centre pivot and lateral move systems. They are suitable for any soil type and undulating country. Overhead irrigation can increase the risk of leaf diseases. Poor quality water applied over the plants will cause leaf damage. Saline water damages young plants. Soluble fertilisers and some pesticides can be applied through the irrigation system.

Drip (trickle) irrigation (Figure 7) is the most easily controlled and efficient irrigation method and is commonly used in Queensland. The equipment to set up the system is expensive but has a long life. The drip tubing is not overly expensive, it allows the use of poorer quality water and doesn't give uneven water distribution in windy weather.

Soluble fertilisers can be applied easily through the irrigation system. If drip tubing is to be re-used it should be treated with chlorine to reduce the risk of blockages. The water must be checked for iron bacteria and treated if necessary.

Furrow irrigation is not commonly used in Queensland but is in the Riverina region of NSW. It requires an even, gentle slope and a soil type that allows water to spread laterally without penetrating too deeply. Furrows longer than 200 m are not recommended in Queensland. For the self-mulching grey soils in the Riverina, the recommend maximum run length is 400 m, with 300 m considered the optimum. Recommended slope for this soil type would be 1:1000 to 1:1200. For the red brown earths, where soils do not sub (allow water to soak laterally to the centre

a key issue



Irrigation methods
Chapter 4 page 155



Figure 7. Drip tape irrigated sweet corn. Note the darker wet area

of the bed) as easily, maximum run lengths of 300 m are recommended. The slope can be a bit less at about 1:1200 to 1:1400.

Water from the end of the rows must be removed to prevent waterlogging of the lower section of the block.

Water quality

Sweet corn is moderately sensitive to saline irrigation water and is most sensitive when very young. The level of salinity that can be tolerated depends on the method and management of irrigation and the soil type.

Because the water is in contact with the leaf, overhead irrigated sweet corn is more sensitive to saline water. Damage may occur when using overhead irrigation if the water has an electrical conductivity (EC) above 1.5 deciSiemens per metre (dS/m). When grown under furrow or drip irrigation, water with an EC up to 2.2 dS/m can be used on some soils provided careful management practices are followed. A yield reduction of 25% or more may occur if water with EC levels above 2.5 dS/m is used.

Table 14 shows the water conductivity threshold at which yield reduction can be expected for different soil types. With good management, higher conductivity water may be useable through drip or furrow irrigation systems and by watering at night with overhead systems.

Table 14. Water conductivity threshold for different soil types

	Sandy soil	Loam soil	Clay soil
Conductivity	2.2 dS/m	1.2 dS/m	0.7 dS/m

Source: NRM Facts, water series W55

Water quantity

Sweet corn needs 4 to 8 ML/ha (megalitres per hectare) of water for overhead irrigation depending on the time the crop is in the ground. Queensland crops tend to be shorter than crops in southern states. The quantity required may be significantly reduced to 3.5 to 4 ML/ha when using drip irrigation. For furrow irrigation the figure can vary from 6 to 10 ML/ha. The amount of water required also varies with the locality and the soil type. As a general rule, sweet corn requires 30 to 60 mm of rain or irrigation per week. Requirements for advanced sweet corn may increase to 80 or 90 mm per week during hot weather. Furrow irrigators may have to irrigate every five to seven days in hot weather.

Sandy soils have a much lower water-holding capacity than clay-based soils and consequently need more frequent irrigation. The soil texture will also determine the amount of water applied at any one time. Water requirements are higher in hot weather than cool weather.



Conversion table for
EC units
Chapter 4 page 154

A commonly used drip irrigation tube with 20 cm outlet spacing and operated at 0.55 bar (8 psi) inlet pressure should deliver about 500 L/hr per 100 m row. The actual quantity applied will vary depending on the amount of slope and the pressure.

Prepare the land

Protect against soil erosion

Steep slopes can cause soil erosion. The degree of land slope that can be used for growing sweet corn is determined by the ability to use spray, planting and harvesting equipment safely and efficiently.

Even, gentle slopes (about 0.5%) are essential for furrow irrigation as soil depressions may lead to waterlogging. If drip or sprinkler irrigation is used, uniform slopes are preferred but not essential.

Whichever irrigation system is used, some form of land levelling is often necessary as sweet corn is prone to waterlogging. Laser levelling is carried out in most growing districts and will improve irrigation efficiency.

Uncontrolled runoff water, particularly during land preparation, will remove valuable topsoil.

There are six important steps in avoiding erosion from runoff.

1. **Build a grassed contour drain across the top of the block.** This drain should have a grade of between 2 and 4% and will catch runoff water from above the block and divert it into waterways running down the slope.
2. **Space waterways 50 m apart.** Make them flat-bottomed, at least 2 m wide and lower than the surrounding land. Where possible, use natural depressions in the block.
3. **Form rows parallel to the top drain** so that water can be channelled between the rows into the waterways.
4. **Build trafficways** beside the waterways.
5. **Plant seed or runners** of couch, kikuyu, carpet grass or similar in the base of waterways and trafficways. Once these structures are established, they can remain as permanent fixtures.
6. **Run rows across the slope** parallel to the contour drain. This layout minimises loss of soil between rows and combines good water infiltration and safe removal of runoff.

These layouts can be used safely on all slopes with a fall of up to 8%.

Crop rotation

Sweet corn is a good rotation and cover crop for many broadleaf vegetable crops.

Cover crops in rotation with cash crops improve soil structure and productivity and reduce pest and disease problems. Cover cropping combined with other soil conservation methods, such as contour banks on steeper slopes, will reduce erosion and help maintain your most valuable asset, your soil.

A guide to land preparation

Table 15 shows a suggested land preparation schedule, including a cover crop, based on the number of weeks before planting.

Table 15. A suggested land preparation schedule for sweet corn

Weeks before planting	Activity
20	Cultivate soil, rip to ensure a minimum soil root zone depth of 50 cm and fertilise if necessary, or add organic material. Plant green manure crop.
10 – 12	Slash or cut with a mulcher to avoid hard fibrous stems.
8	Sample soil for a nutrient analysis.
4 – 6	Mulch, then incorporate the green manure crop. Apply and incorporate lime, dolomite or gypsum according to soil nutrient analysis results.
2 – 4	Disc or tine cultivate once or twice to control weeds and ensure a minimum soil root zone depth of 50 cm soil. Incorporate basal (pre-plant) fertiliser.
0 – 1	Final working of soil just before planting. Apply trace elements if required.
0	Plant the crop. Apply fertiliser if it has not been applied previously.

Initial cultivation. If your land is under grass or weeds, plough or disc-cultivate the block. A hard pan or compaction layer may be formed from regular use of a rotary hoe and other cultivation equipment or from heavy traffic movement (Figure 8). This causes reduced plant growth and waterlogging in some situations. If you suspect that you may have a hard pan, dig a hole and check. Deep rip in both directions to break this hard pan. If the soil is wet it will not shatter; if too dry large clods will be formed.

Ripping is best done immediately after final harvest to allow deep water penetration during the fallow which helps to leach salts out of the root zone.

In self-mulching (cracking) clay soils, a hard pan may be broken by using a summer forage sorghum crop. This crop dries the soil profile, causing shattering of the compacted layers. On these soil types, this practice has been shown to be more effective than deep ripping.



Figure 8. Root system affected by a compaction layer

Organic additives. Most sweet corn growers don't use organic additives such as animal manures, mill mud etc, but they are beneficial if soil organic levels are very low, less than 0.5 to 1%.

Cover crops or green manure. Sweet corn is itself a good cover crop and is often used in rotation with winter vegetables. Cover crops help to build up soil organic matter, which is reduced by cultivation. These crops are particularly important in light, sandy soil. Organic matter is usually expressed as organic carbon in a soil analysis. Other benefits of cover crops include:

- improved soil structure and internal soil drainage;
- improved water-holding capacity;
- reduced leaching of nutrients;
- increased activity of micro-organisms;
- reduced soil erosion;
- reduced pest and disease problems;
- reduced weed growth;
- recycling of nutrients.

A well grown cover crop will add organic matter and help smother weeds. Extra nitrogen (30 kg/ha of nitrogen) may be needed if the cover crop is slashed several times or if growth is slow.

Legumes such as cowpea and dolichos lablab are susceptible to nematodes, particularly in sandy soils. All cover crops should be either ploughed in or slashed before they set seed to prevent them becoming a weed in the following crop.

Incorporate organic matter into the soil well before planting so it decomposes completely to avoid serious losses from damping-off diseases in following crops. Decomposition takes about four weeks in warm, moist soil and eight weeks or longer in cold or dry weather.

In very dry conditions, it may be necessary to apply about 25 kg/ha of urea and irrigate to encourage decomposition by soil micro-organisms. Otherwise the organic matter decomposes when the crop is first irrigated, resulting in heavy seed and plant losses.

Summer. Broadcast hybrid forage sorghum seed over the cultivated land at 20 to 30 kg/ha. Use the higher rate where the seedbed is rough or the seed will not have good soil contact. For best germination, use harrows or a light tined implement after planting to mix seed into the soil. Light rolling will improve germination by ensuring that seed is in

closer contact with the soil. Rainfall or irrigation is necessary to ensure germination and establishment of the cover crop.

Forage sorghum can be ratooned several times by slashing back to a height of 20 to 30 cm. Extra nitrogen may be required if the crop is slashed and allowed to regrow. Plough in before seed heads develop and the stems become too fibrous to decompose rapidly.

The legume dolichos lablab, or hybrid forage sorghum is planted from November to January. Dolichos is a minor host for silverleaf whitefly but populations of this insect have not been observed to build up on dolichos. It is unlikely that using this legume as a summer cover crop will have a significant effect on whitefly populations.

Winter. Cereals such as oats, ryecorn, triticale or barley at 75 kg/ha are suitable winter cover crops. Use oats for early planting and barley for late planting.

Soil analysis. Take a soil sample six to eight weeks before your intended planting date to ensure the results and interpretation are available and treatments can be applied before planting. Follow the sampling instructions supplied by the laboratories.

A soil analysis measures the pH, conductivity, organic matter and the level of nutrients in the soil. Results will be interpreted by the laboratory, reseller or consultant. Your experience of the block of land and the way you wish to manipulate the growth of the crop, will influence your interpretation of the soil analysis and recommendations.

Soil pH. The pH level is a measure of the soil's acidity or alkalinity on a scale from 0 to 14, with 7 being neutral. A pH of 5 is 10 times more acid than a pH of 6. Sweet corn can tolerate a pH range from 5.5 to 7.5, but prefers a slightly acid soil, around 6.0 to 6.5. In this range, most major and trace elements present in the soil are available to the plants, without being at toxic levels. Adjust if it is below 5.5. Acidic soils require the addition of lime or dolomite to raise the pH and increase calcium and magnesium levels respectively. A complete soil analysis will show which form is most suitable by showing the available levels of calcium and magnesium.

Figure 34 in Chapter 4, page 142 is a guide to the application rates for lime.

Research has shown that for every tonne of lime applied, the pH will change 0.1 to 0.8 units (generally 0.2 to 0.3 units). Commercial application rate is about 2 t/ha of lime. Applications of more than 2.5 t/ha on sandy soils, 4 t/ha on loam soils or 5 t/ha on clay soils are not recommended.

Gypsum. Gypsum will increase soil calcium levels but not change soil pH. Gypsum can also improve the structure of some soils; test your soil

Table 43 in Chapter 4, page 142 shows the appropriate management of calcium, magnesium and pH.

to ensure gypsum will help. It takes about one year for the physical effects of gypsum on the soil structure to become apparent. Apply gypsum before the wet season so that it can leach accumulated salts beyond the root zone well before planting.

An application of 5 to 10 t/ha of gypsum can benefit clay loams that have high sodium levels.

Trace elements

Other elements may also be deficient in some soils and may need to be corrected. A complete soil analysis taken six to eight weeks before planting will indicate which elements are deficient. They are often applied as foliar applications once the plants are established. Some, however, may be applied to the soil during ground preparation.

Boron (B). Where soils are known to be deficient, boron can be applied as Solubor, dissolved in water and sprayed onto the soil with a boom spray.

Applications on neutral to acid soils are more effective. High soil pH, high calcium levels, soils with high clay content or recently limed soil can all reduce the ability of plants to take up boron. In these situations, foliar applications of boron can be applied.

Zinc (Zn). Zinc is a very important trace element and can be locked up in high pH soils. Soil applications are most effective. Applications may be broadcast over the entire area or banded in the rows. Zinc may also be applied to the crop as a foliar spray of zinc sulphate but should be applied within four weeks of plant emergence.

Applications are best made by broadcasting zinc sulphate monohydrate onto the soil before planting or applying zinc sulphate heptahydrate. This form of zinc can be dissolved in water and sprayed onto the soil using a boom spray or injected through the drip irrigation system.

Table 16 shows soil application rates for boron and zinc.

Table 16. Soil application rates to prevent boron and zinc deficiency

Element	Product	Rate	Comments
Boron	Solubor (20.5% B) Solubor DF (17.4% B)	1.25 – 2.5 kg/ha	Spray on soil before planting and work it in. Do not tank mix with zinc.
Zinc	zinc sulphate monohydrate (35% Zn)	20 – 30 kg/ha	Broadcast onto the soil before planting and work it in.
	zinc sulphate heptahydrate (22% Zn)	40 kg/ha	Spray on soil or apply through drip tape. Do not tank mix with boron.

Soil fumigation

Fumigation is rarely used in sweet corn production due to the high cost. Sweet corn also has a relatively high resistance to soil-borne pathogens. Where soil-borne organisms are causing problems, crop rotation is generally the best remedy.

Final land preparation

Soils are normally worked twice with disc or tine cultivators and then brought to a clod-free condition using rigid or spring tine cultivators and harrows. A rotary hoe or power harrow is commonly used for final land preparation. Soil should be well aerated, free of compaction layers and have a fine tilth to get good contact with the seed.

Lay out the field

Supersweet varieties must be planted at least 200 m away from other types of sweet corn or maize and preferably upwind. This is to prevent cross-pollination that can result in starchy kernels. It is also possible to separate crops by planting at different times so that silking of the supersweet variety does not coincide with pollen shedding from any other type of sweet corn or maize crops. Allow a gap of 14 to 21 days to avoid cross-pollination.

Fields are laid out according to the irrigation system used, harvest time, harvest system and yields expected. The size of the planting is determined by the capacity of the packing shed or factory and the buyer's requirements.



Figure 9. A high clearance spray rig in a sweet corn field

If aerial spraying or high clearance tractors (Figure 9) are used, access roads are usually only placed between different plantings.

If ground spray rigs are used, the area to be planted is divided into lands, each land being twice the operating width of the spray equipment to be used (Figure 10). Access tracks of 3 to 4 m wide are run between these lands. Row spacing within each land is normally 0.75 m but depends on the row spacing of the harvester.

The length of row used with drip irrigation depends on the slope of the land. Under ideal conditions the accuracy of water distribution decreases after about 120 m. Additional 'lay flat' tubing can be placed across the rows to increase row lengths.

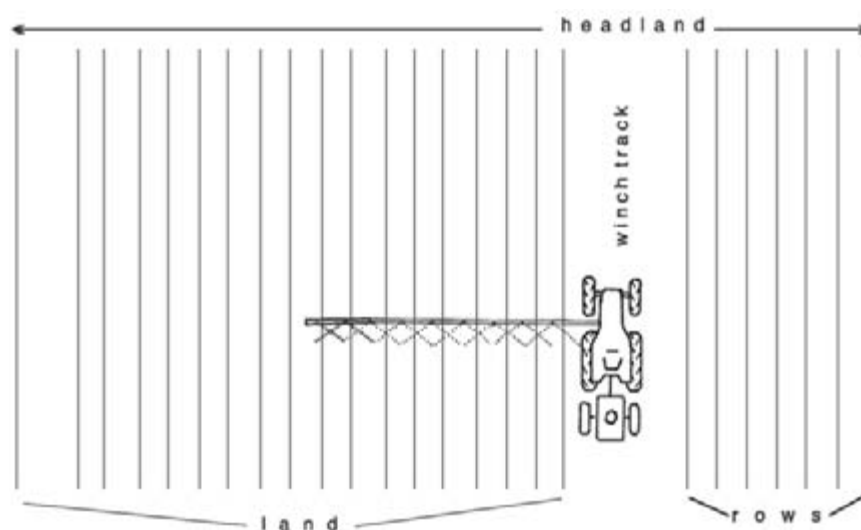

Figure 10. Field layout in relationship to the width of a boom spray

It is preferable to have the rows orientated north-south. This allows better light penetration and air movement, reducing humidity and thus disease outbreaks.

If possible, divide blocks into uniform soil types for easier and more efficient cultivation, irrigation and fertilising. Provide all weather access to the block and allow room for vehicles to turn easily at the end of the rows. Design the layout so that new plantings are made upwind where possible to reduce pest and disease movement from older crops to younger plantings.

Plastic mulch

Plastic mulch is not generally used for sweet corn growing. However, some growers double crop following another vegetable crop (for example tomatoes, capsicums). The sweet corn is then sown through the old plastic mulch.

Drip irrigation

Lay drip tubing with the holes up, to prevent blockages from sediments. The drip tubing is best buried about 3 to 5 cm deep, this helps prevent any 'snaking', so the drip tubing maintains its position between the rows. Lay the tubing in the middle of every second pair of rows. The water should soak across to irrigate one row each side of it. To cultivate between the rows, remove the cultivator above the drip tube. On sandy soils you may need drip tubing for each row.

The capacity, quality and price of drip tubing varies depending on the type and manufacturer. Cheaper, thinner, one-use only tubing is



Cleaning drip tubing
Chapter 4 page 165

commonly used and discarded after the crop has been harvested. Crickets can cause serious damage to thin tubing by chewing holes in it, however they do not normally damage thicker tubing. Thicker, more expensive tubing is more suitable for multiple use. Take care in maintenance and retrieval of this type of drip tubing.

Emitters are usually spaced 20 or 30 cm apart. The closer spacing is used where lateral movement of water is poor, for example sandy soils, and the wider spacing where lateral water movement is good, for example heavier clay soil types. Table 17 shows the length of drip tubing required per hectare at various row spacings.

Table 17. Length of drip tubing required per hectare of crop

Distance between rows	Metres of drip tubing per hectare	
	1 tube per row	1 tube per 2 rows
100 cm	10 000 m	5 000 m
95 cm	10 525 m	5 263 m
90 cm	11 111 m	5 556 m
75 cm	13 333 m	6 667 m
50 cm	20 000 m	10 000 m

Apply fertiliser

Sweet corn requires careful nutritional management to ensure high yields. Follow the recommendations from your soil analysis when applying fertiliser. Nitrogen is a vital element as is potassium. Low nitrogen levels before tasselling (30 to 50 days after emergence) can affect cob size, and if low at silking and grain fill will affect kernel development and fill.

Fertilisers are commonly sold as mixtures of the major elements, nitrogen (N), phosphorus (P) and potassium (K). The percentage of each of these elements in the mix is expressed as a ratio of N:P:K. For example 100 kg of a fertiliser with an N:P:K ratio of 15:4:11 contains 15 kg nitrogen, 4 kg phosphorus and 11 kg potassium.

Other elements that are required in relatively large amounts include calcium, magnesium and sulphur. Sulphur is usually found in sufficient quantities in most commercial N:P:K fertilisers, superphosphate, gypsum and sulphate of potash. Lime, dolomite and gypsum are sources of calcium. Dolomite and magnesium sulphate are sources of magnesium.

Fertiliser should be applied before or at planting (basal) and as side-dressings as the crop grows.



Using these products
Table 43
Chapter 4 page 142

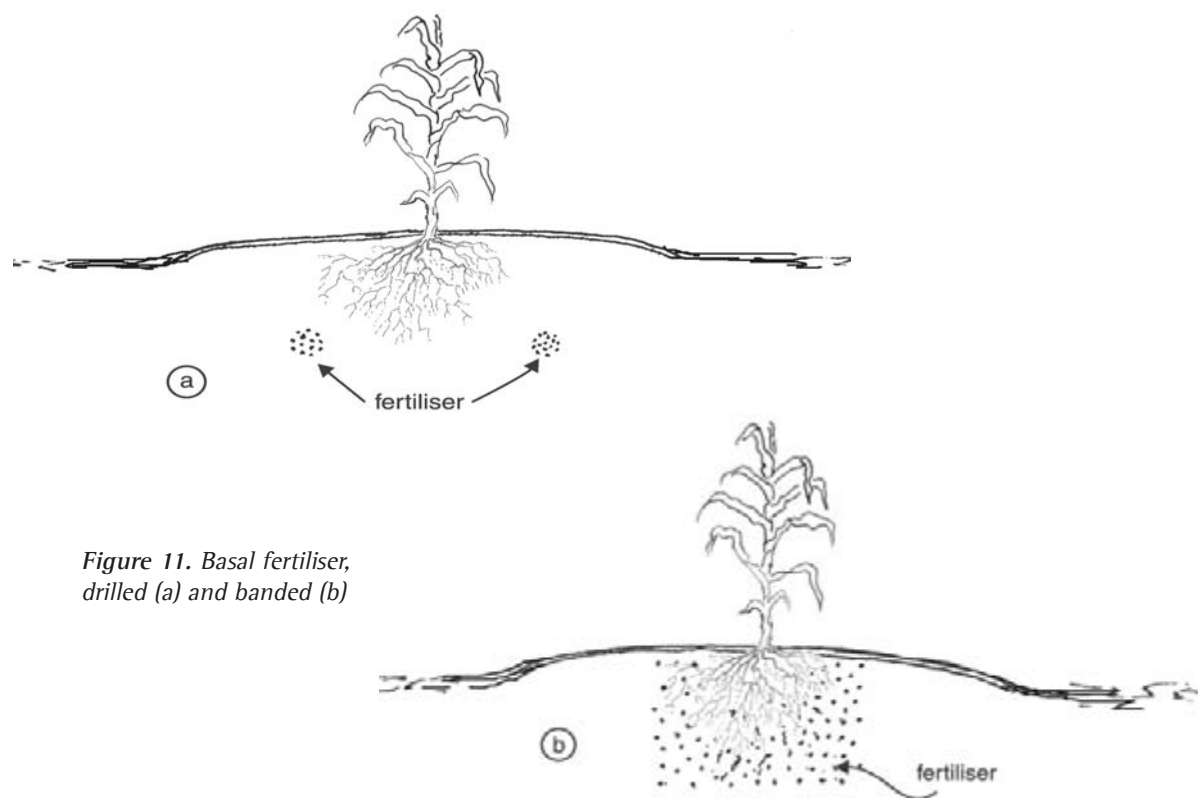

Figure 11. Basal fertiliser, drilled (a) and banded (b)

Basal fertiliser

Basal fertiliser requirements should be determined from the results of a complete soil analysis. The soil type is very important—sandy soils require higher rates of fertiliser than loams. Rates will also depend on previous cropping history.

Basal fertiliser may be spread over the soil surface and incorporated into the soil during final soil preparation, or drilled in narrow bands 5 cm to the side and 8 cm deep at planting (Figure 11). In the Riverina, anhydrous ammonia is commonly used. It is drilled into the soil 15 to 20 cm deep to avoid both gas loss and potential seed damage.

If a soil analysis is not available, the programs shown in Tables 18 to 20 may be used as a guide.

Queensland

For fresh market crops apply a basal fertiliser that will supply about the following amounts of major nutrients: 90 kg of nitrogen (N), 25 kg of phosphorus (P) and 70 kg potassium (K) per hectare. Apply fertiliser in a band at planting, or incorporate into the plant rows with the final cultivation before planting. Table 18 shows fertiliser rates for an N:P:K mixture commonly applied in Queensland.

Table 18. Fertiliser rates and element supplied for a common N:P:K mixture in Queensland

N:P:K mixture	Quantity to apply	Element applied (kg/ha)		
	kg /ha	N	P	K
15:4:11	600	90	24	66

New South Wales

In the central west, growers commonly drill urea into the soil as a basal fertiliser about a week before planting. At planting, mono ammonium phosphate (MAP) and sulphate of potash are applied to give a total basal fertiliser of 120 kg of N, 44 kg of P and 41 kg of K per hectare.

In the Riverina, growers commonly inject anhydrous ammonia 15 to 20 cm into the soil, three to four weeks before planting and apply MAP at planting, giving a total basal rate of 135 kg of N and 44 kg of P per hectare. Potassium may be applied if indicated by soil tests. Table 19 shows the basal fertilisers commonly used in NSW.

Table 19. Fertiliser rates and elements applied in NSW

District	Fertiliser applied	Time of application	Quantity	Element applied (kg/ha)			
			kg /ha	N	P	K	S
Central west	urea	1 week before planting	217	100	0	0	
	MAP	at planting	200	20	44	0	0
	sulphate of potash	at planting	100		0	41	18
			Total	120	44	41	18
Riverina	anhydrous ammonia	3 – 4 weeks before planting	140	115			
	MAP	at planting	200	20	44		
			Total	135	44	0	0

Victoria

Basal fertiliser can be banded separate from the seed, or on less fertile soils, drilled in at a higher rate. Table 20 shows the basal fertilisers commonly used in Victoria.

Table 20. Fertiliser rates and element supplied for a common N:P:K mixture in Victoria

N:P:K mixture	Soil fertility	Quantity to apply	Element applied (kg/ha)		
		kg /ha	N	P	K
12:12:17	good – average fertility	500	60	60	85
8:10:10	good – average fertility	600	48	60	60
12:12:17	low fertility	700	84	84	119
8:10:10	low fertility	900	72	90	90

Control weeds

Weed control begins with the ploughing in of the previous crop before weed seeds can germinate. Regular cultivation with tined implements will prevent a build-up of weeds and cause less damage to soil structure than discs or a rotary hoe. If a good cover crop is planted, most weeds will be smothered.

The interval between cultivations allows some weed seeds to germinate and these are killed by the following cultivation. This reduces the overall seed population in the block.

Mechanical inter-row cultivation is regularly used for weed control in sweet corn and can be the cheapest method if seed-bed preparation before planting was thorough.

Chemical weed control

There are a number of herbicides registered for chemical weed control in sweet corn. Each chemical controls a particular range of weeds, so it is important to know what weeds need to be controlled, then select the herbicide which will come closest to those requirements.

Some of these herbicides are prescribed chemicals in Victoria and an Agricultural Chemical Users Permit is required to legally use prescribed chemicals.

Before using a residual herbicide, consider the susceptibility to the herbicide of the crop you intend to plant next, and the length of time the herbicide remains active in the soil. Cucurbit crops, for example melons, pumpkins and zucchinis are very susceptible to damage from residual herbicides. The herbicides listed in Table 21 are registered for weed control in sweet corn. Select the most suitable herbicide from this group depending on the situation and the weeds to be controlled.

Most pre-emergent herbicides need to be either mechanically incorporated, for example with a power harrow or rotary hoe, or be watered in with rain or overhead irrigation.

Read the label carefully before using a herbicide. Note the rate of application and the specific conditions under which it should be applied.

Table 21. Pre-emergent herbicides

Chemical	Comments
atrazine	Needs rain or irrigation within 10 days of application. Controls grass and broadleaf weeds.
EPTC	Use a higher rate on heavier soils (Queensland only). Mechanically incorporate immediately after application to a depth of 5 to 10 cm. Note: maize and sweet corn are initially susceptible to EPTC, delay sowing until 7 days after application. DO NOT sow deeper than 5 cm. Read label for more information on nut grass and couch control.
linuron	Apply as a band or broadcast treatment immediately after planting. DO NOT use on light sandy soils low in clay or organic matter. Heavy rains after application may cause crop damage.
metolachlor	Apply before, at, or immediately after planting and before crops and weeds have germinated using a low volume boom sprayer applying 60 to 120 L/ha. Rain or irrigation is necessary within 10 days of spraying to thoroughly wet the top 3 to 4 cm of soil. If rain does not occur or irrigation is unavailable, incorporate chemical to a depth of 3 to 4 cm. Controls grass and broadleaf weeds.
metolachlor + atrazine	Apply before, at or immediately after planting and before crops and weeds have germinated using a low volume boom sprayer applying 60 to 120 L/ha. Pre-plant: Apply the product to an even, un-ridged seedbed and incorporate with suitable harrows (e.g. 5 row) or when sowing occurs shortly after application by the planting operation trailing covering harrows. Post-plant: If the soil is ridged, cloddy or with heavy trash at application, mechanical incorporation is not recommended. Rainfall or irrigation is required to incorporate and activate the product. Moisture in the top 3 to 4 cm of soil is required to keep the product activated. In flood or furrow irrigation situations, mechanical incorporation is required to ensure the irrigation water comes in contact with the product to ensure activation. Controls grass and broadleaf weeds.
S-metolachlor	Apply before, at or immediately after planting and before crops and weeds have germinated using a low volume boom sprayer applying 60 to 120 L/ha. Rain or irrigation is necessary within 10 days of spraying to thoroughly wet the top 3 to 4 cm of soil. If rain does not occur or irrigation is unavailable, incorporate chemical to a depth of 3 to 4 cm. Controls grass and broadleaf weeds.
S-metolachlor + atrazine	Apply before, at or immediately after planting and before crops and weeds have germinated using a low volume boom sprayer applying 60 to 120 L/ha. Pre-plant: Apply the product to an even, un-ridged seedbed and incorporate with suitable harrows (e.g. 5 row) or when sowing occurs shortly after application by the planting operation trailing covering harrows. Post-plant: If the soil is ridged, cloddy or with heavy trash at application, mechanical incorporation is not recommended. Rainfall or irrigation is required to incorporate and activate the product. Moisture in the top 3 to 4 cm of soil is required to keep the product activated. In flood or furrow irrigation situations, mechanical incorporation is required to ensure the irrigation water comes in contact with the product to ensure activation. However, immediate post-sowing application followed by irrigation with drip tape has given good results without mechanical incorporation. Controls grass and broadleaf weeds.
propachlor	Apply as a surface spray immediately after seeding in at least 200 L/ha of water to weed-free soil. Controls grass and broadleaf weeds.

Plant

Do not plant when soil temperatures are less than 14°C, especially supersweet corn. Higher temperatures will result in quicker and more even germination and emergence.

Sweet corn is usually sown into finely tilled flat ground, but in some districts, beds are formed before planting for flood and drip irrigation. Basal fertiliser can be applied during the planting process.

Seed treatments

Commercial sweet corn seed is generally treated with a fungicide and no additional seed treatments are required.

Planting methods

Vacuum precision planters are used in preference to belt or plate type planters because the latter types often result in irregular plant spacing within the rows. Seed of supersweet varieties are small and fragile so must be handled with great care to prevent damage and lower germination. Figure 12 shows a two-row planter that also applies basal fertiliser and lays drip tape.

Standardisation of planting and cultivating equipment is important to ensure compatibility of machinery. Row spacings need to line up for sowing, cultivation, spraying and harvesting. Harvesting equipment usually determines row spacing.

Sweet corn is normally 'once over' mechanically or hand harvested, therefore uniform crop maturity is essential. A uniform plant stand is required to achieve uniform maturity. To achieve this, seed placement (depth, row spacing, spacing within the row) must also be uniform.

Planting technique

Seed of supersweet varieties are small with low vigour, making planting depth critical. Use a precision planter to plant seed at an even depth, no greater than 3 cm, into a well-tilled warm soil. Adverse conditions at or following planting can contribute to poor germination and emergence.

Seed of normal (standard) varieties can be sown 3.5 to 5 cm deep, but if the soil is cold or the seed has a low germination, plant at 2.5 cm depth. Emergence can take five to 15 days depending on weather.

Irrigate

Loamy soils should be sufficiently moist before planting to allow germination and emergence to occur without irrigation being required. For heavy clay or very sandy soils, seed is planted into dry soil and then irrigated to assist germination and emergence.

Crusting of some soils can result in poor emergence and an uneven plant stand. If planting into crusting soils, regular light irrigations will be necessary to ensure seedlings are able to emerge through the crust.

Alternatively, a cultivator can be used to knock the crusted top off the seedbed immediately before planting.



Figure 12. Side and rear views of a two-row planter also applying basal fertiliser and laying drip tape





Planting to tasselling

This is the stage that varies the most depending particularly on variety and temperature. It usually takes 35 to 66 days. There are four important things to manage during this stage.

Monitor soil moisture and irrigate

Manage pests and diseases

Control weeds

Manage plant nutrition

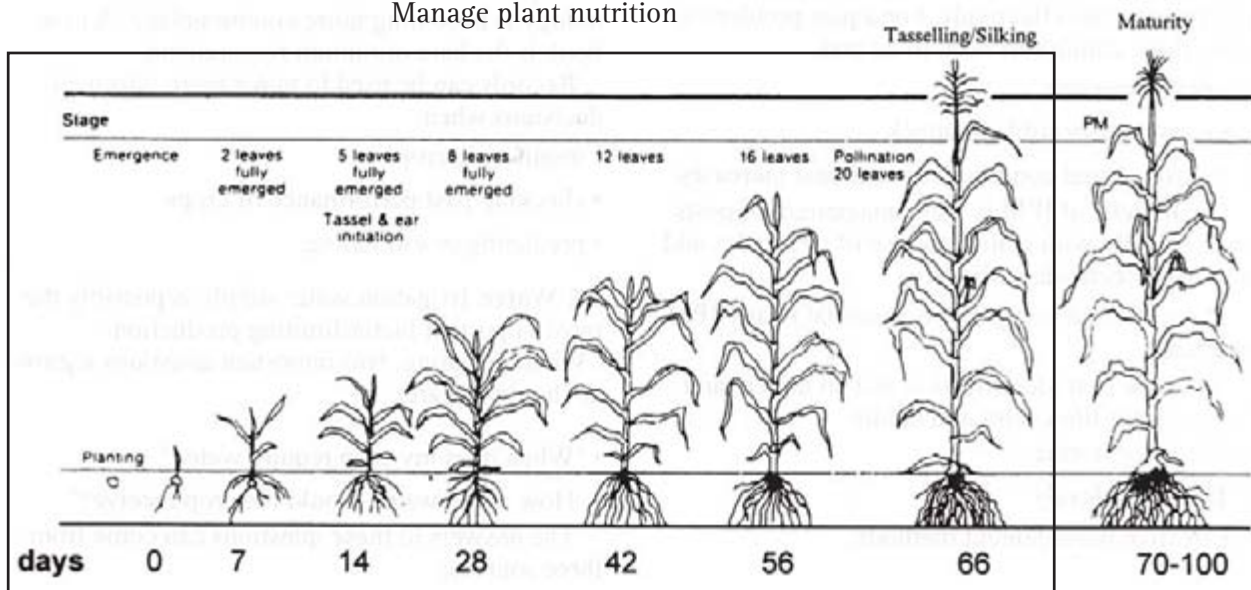

Figure 13. The frame indicates the planting to tasselling stage. (Source: 'Growing sweet corn'. Agfact H8.1.39)

Monitor soil moisture and irrigate

Sweet corn has a high water requirement, particularly from tasselling to harvesting. Leaf rolling is an indication of water shortage or stress in the plant. Leaf rolling can occur under very hot conditions even if soil moisture would normally be considered adequate. Leaf blasting (damage) may occur during hot, dry, windy weather.

Irrigating once plants are established

Good irrigation practices are essential to produce acceptable yields of high quality sweet corn. Crops grown without irrigation are generally poor. Non-irrigated or poorly irrigated plantings produce smaller plants with poorly filled cobs and are not economically viable.

Apply water in small quantities frequently, until plants have sufficient root volume for tensiometers to be effective. Do not over-water, especially when the soil is cold. Over-watering will cause nutrient leaching and waterlogging around the young plants and encourage seed and seedling rots.

An understanding of the plant's growth cycle will help with crop management. See Chapter 6, *Crop Management handy guide*

If using an overhead system, irrigate in the morning, so that plant foliage is dry by evening. This will reduce the risk of leaf disease infection.

Water quality

Sweet corn is moderately sensitive to saline irrigation water, but most sensitive when young. Recheck the quality of your irrigation water to make sure it is still suitable for irrigating sweet corn. Sweet corn grown under overhead irrigation is more sensitive to saline irrigation water because the water leaves traces of salt which will damage leaves.

Table 22 shows the water conductivity threshold at which yield reduction can be expected for different soil types. With good management higher conductivity water may be useable through drip or furrow irrigation systems. Furrow irrigation, however, can concentrate salts in the planting hill and it is safest to use lower conductivity water than can be used with drip irrigation.

Table 22. Water conductivity threshold for different soil types

	Sandy soil	Loam soil	Clay soil
Conductivity	2.2 dS/m	1.2 dS/m	0.7 dS/m

Source: NRM Facts, water series W55

Irrigation scheduling

Critical times for irrigation are tasselling, silking and cob fill. Cob initiation is underway from weeks four to six. The most critical time to prevent any moisture stress is from three weeks before silking to two weeks after silking. Moisture stress at critical times can result in small cobs or lead to poor pollination and blanking.

Less frequent but increasing quantities of water are required once the plants are established.

The decision on when to irrigate has often been made by feeling the soil, looking at the plants or watering at a pre-determined time interval. It is better to use instruments to schedule irrigation with much greater precision. There is a range of instruments that measure soil moisture, including the neutron probe, Enviroscan, Gopher, Time Domain Reflectometry (TDR), DRW Microlink and Aquaflex. To ensure accurate readings, take care to maintain equipment properly to keep it in good working order. Capacitance probes and tensiometers are the most commonly used scheduling instruments.

Capacitance probes. These include Enviroscan, Diviner and Gopher equipment, they are expensive pieces of equipment, which are generally used only by crop consultants and large growers. They use electrical induction to give a complete profile of moisture conditions throughout the root zone. By using this information, you can determine the daily



Irrigation
Chapter 4 page 158

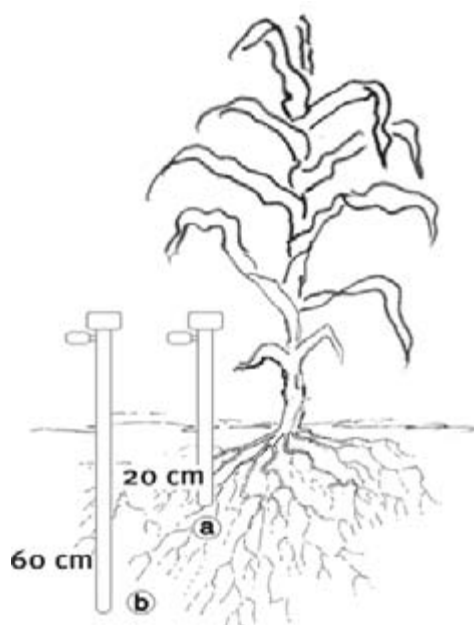

Figure 14. Tensiometers in place, (a) in root zone and (b) below main roots

water use and time to the next irrigation. They can also be a good guide to how much water to apply.

Tensiometers. These are comparatively cheap and effective instruments for irrigation scheduling, however they do require frequent maintenance. They show changes in soil moisture, so indicating the actual needs of the crop.

Depending on soil variability, select at least two sites per 5 ha and install two tensiometers per site. Place the tip of the shallow tensiometer in the root zone about 20 cm deep and the deep tensiometer just below the main root zone at about 60 cm deep. Place the tensiometers midway between plants in the row. Figure 14 shows the correct placement for tensiometers. The shallow tensiometer indicates when to irrigate, while the deep tensiometer indicates how much water to apply.

Once tensiometers are installed, read the gauge to determine when to water. Read tensiometers between sunrise and 8 a.m. because at that time there is little movement of water in the soil or plants and they are almost in equilibrium. Errors caused by heating of the gauge or water column are also avoided.

It is a good idea to plot the daily readings on a chart. The chart lines show what has happened in the past and, by extending them, you can anticipate what will happen over the next few days.

The shallow tensiometer indicates when to irrigate, the deep tensiometer indicates when the right amount of water has been applied. If deep tensiometer readings fall to less than 10 kPa within two days after irrigation, there is more water than the root zone can hold. Constant values after irrigation indicate the root zone is saturated. If readings continue to rise immediately after irrigation, not enough water has been added to the root zone.

Apply irrigation at different readings depending on soil type and stage of growth. Table 23 is a guide to when to irrigate during this stage. The tensiometer should not remain below 10 centibars except just after irrigation.

Table 23. Shallow tensiometer reading at which to commence irrigation up to the tasselling stage

Soil type	Tensiometer reading
Sandy loams	40
Clay soils	45 – 60

Water quantity

The amount of water required depends on the type of irrigation used, the locality and the soil type. As a general rule, sweet corn requires 30 to 60 mm of irrigation and/or rainfall per week. The soil texture is important in determining the amount of water required and the amount applied at any one time. Water requirements are higher in hot weather than cool weather.

Sandy soils have a much lower water-holding capacity than clay-based soils so need smaller, more frequent applications of water. Heavy water applications, particularly on sandy soils, will leach nutrients out of the root zone. This wastes fertiliser, possibly affects the ground water, and reduces plant growth and health.

Irrigation scheduling equipment will also provide information on how much water to apply.

Manage pests and diseases

Pests and diseases are likely to threaten at some stage and can cause major and even total crop losses. Good management of pests and diseases involves using an integrated pest management (IPM) approach. This includes monitoring and decision making, timely spray applications (only when required), targeting specific parts of the plant at critical times, protecting beneficials, and using biological pesticides when appropriate. Efficient, well-maintained and calibrated spray equipment is essential for good pest management.



*Pest and disease
management*
Chapter 4 page 185

Photos of the problem, causes and possible solutions can be found in the companion book available from DPI&F offices—

PICTURE GUIDE:
*Sweet corn problem
solver & beneficial
identifier*

Problem identification

Correct identification is the first step to controlling pests and diseases. Is the problem caused by an insect, mite, nematode, fungus, bacteria, or virus, or is it a nutritional or physiological problem? Management will be different in each case. To manage these problems, learn as much as possible about the pests and diseases, including identification and life cycles, and their recommended management.

Understanding pest and disease management

The saleable product, the cobs, develop some weeks after planting, so some level of leaf damage can be tolerated before marketable yield is affected.

Some diseases may require regular spraying, up to every 10 days at certain stages of the crop, depending on disease incidence and weather conditions. Check the withholding period of the pesticide.

Plants can tolerate small numbers of pests without them significantly affecting yield or quality. In these cases, the cost of spraying is much

greater than the benefit gained by controlling the insects. Make sure that insect levels are high enough to warrant spraying, as this will save money and reduce the risk of spray burn, chemical residues in the environment and insecticide resistance.

Monitoring

Frequent monitoring is the basis for good management decisions. This should be done at least once per week up to tasselling, then twice a week from tasselling to harvest. It is critical that you monitor your crop from the late vegetative stage onwards.

Before tasselling look at the whole plant. From the start of tasselling, concentrate on the tassels and then the silks when they appear until they brown off; intensive monitoring is then no longer required.

Insect and mite pests

Seed germination to early establishment. Check your crop regularly during the first few weeks for cutworm, wireworm and earwig damage. Cutworms chew plants off just above ground level. They curl up in the soil at the base of the plant and under soil clods during the day and can be found by scratching around the base of plants. Wireworms will also chew the plant stem below ground level. Earwigs will eat newly sown and germinating seed and the plant roots. White-fringed weevils occur in some areas and can cause similar damage to earwigs. They may be a problem if sweet corn is following pasture or lucerne crops.

Early establishment to tasselling. Pests at this stage include, aphids, armyworms, heliothis, leafhoppers, planthoppers, Rutherglen bugs, thrips, two-spotted mites and green vegetable bugs.

The first step in managing these pests is to correctly identify the insect or mite.

Diseases and disorders

Most diseases are more common during warm, wet weather, so present or imminent weather conditions will influence your management decisions. If, following monitoring, your decision is to spray choose a fungicide from the *Chemical handy guide*.

The main problems at this stage are:

- virus diseases such as Johnson grass mosaic virus and maize stripe. They are spread by aphids and the maize planthopper respectively. Control for maize stripe is not warranted while the only control for Johnson grass mosaic virus is to plant resistant varieties, for example Hybrix 5. More resistant sweet corn varieties are being developed.

a key issue



Pest and disease
management
Chapter 4 page 185

The causes and possible solutions along with colour photos of problems with insects, mites, diseases and disorders, can be found in the companion book available from DPI&F offices—

PICTURE GUIDE:

*Sweet corn problem
solver & beneficial
identifier*

a key issue



Varieties
Chapter 4 page 135

- wallaby ear, a disorder caused by toxins injected by maize leafhopper. To reduce the risk of wallaby ear it is important to control leafhoppers in the young crops.

Check your crop regularly for these problems and if necessary apply a registered pesticide from the *Chemical handy guide*.

Selecting pesticides

Only pesticides registered for the control of the particular pest on your crop can legally be used. Use the most effective pesticide for the particular problem. All states operate under the Australian Pesticides and Veterinary Medicines Authority (APVMA), however Victoria also has its own 'control-of-use' legislation.

Victorian legislation. In Victoria, an Agricultural Chemical Users Permit (ACUP) is required before you can legally use a restricted group of agricultural chemicals. These are products that contain atrazine, metham sodium or ester formulations of MCPA, 2,4-D, triclopyr or Schedule 7 poisons. Use of these chemicals must be strictly in accordance with label directions and records of use must be kept. A pre-requisite for an ACUP is a recognised qualification such as the Farm Chemical Users Course.

For other registered chemicals, off-label use is allowable provided it is not used:

- at rate that is higher than the maximum rate stated on the label, or
- at more frequent intervals for that use than stated on the label, or
- for use in a particular manner or for a purpose if the label specifically states that it must not be used in that manner or for that purpose.

NOTE

All aspects of such off-label use including residue controls, environmental safeguards, occupational health and safety and animal welfare are the user's responsibility.

Off-label use is defined as when an agricultural chemical product is not used strictly in accordance with the label directions. Examples include:

- the use of a product at lower than label rate;
- use on a pest not stated on the label;
- mixing two pesticides together, which have no label compatibility statements and applying them in one operation instead of two.

Pesticide action

Pesticides are either protectant or curative, and systemic or non-systemic.

Protectant fungicides are usually not systemic in the plant and will not eradicate a disease. They provide a protective cover that prevents the disease from getting established, so good coverage is essential.

Eradicant fungicides will control a disease that is already established.

Warning

Check the *Chemical handy guide* or your local supplier for what pesticides are registered on sweet corn in your state.



a key issue



Pesticide application
Chapter 4 page 216

Where to get the DPI&F book, *Pesticide application manual* Chapter 5 page 253

WARNING

Always read the label before opening a pesticide container.

Systemic pesticides penetrate the leaf or roots into the sap stream and are transported through the plant via the sap stream. They will control insects and diseases that are already established. Although coverage is not as important with systemic pesticides, good coverage will give best results.

Application of pesticides

Most pesticides are applied as sprays. The results from spraying will only be as good as the coverage you achieve with your equipment. Hydraulic sprayers such as boom sprays, air-assisted machines and controlled droplet applicators (usually on aircraft) are all used.

Hydraulic sprayers are the most common and it is important that they are set to provide maximum coverage of the target, for example the silks and the cob. Aerial spraying is also used for large areas or where tractor access is restricted or difficult.

Good pest control is only achieved through thorough coverage of the plant, particularly where protectant pesticides are used. The ideal droplet size for insecticides and fungicides ranges from 150 to 200 microns but droplet sizes up to 350 microns may be used to reduce spray drift. Flat fan nozzles are often used on droppers in Queensland because they give a wider angle of spray and the larger droplets are less likely to drift. Hollow cone nozzles give a greater range of droplet sizes and are commonly used when droppers are not attached or spray drift is not a problem.

Spray equipment must be calibrated regularly to achieve good coverage. Before calibrating your sprayer, measure the output of each nozzle for a set time, for example 30 seconds, and discard any nozzle that varies more than 10% from the others. This may be every 10 hours when wettable powders are used through brass jets.

Do not apply herbicides with your pest and disease sprayer. This avoids the risk of herbicide residues in the sprayer damaging the crop.

For more detail on safe and efficient spray application refer to the DPI publication *Pesticide application manual*.

Care with pesticides

Pesticides should always be handled responsibly and with care; most are dangerous, particularly when undiluted. Agricultural pesticides must be stored in accordance with the AS2507-1998 standard.

Protective clothing, including boots, overalls, gloves and a mask, should be worn at all times. Use pesticides according to directions only. Avoid spraying if spray is likely to drift away from the target area. Only use chemicals registered for use on your crop.

more info



Contact details for
spray accreditation
Chapter 5 page 241

You will need to obtain a spray accreditation before you can purchase some pesticides.

Disposal of pesticides

A major problem facing chemical pesticide users is the disposal of empty containers and unwanted chemicals. The national program for the collection and recycling of empty, cleaned, nonreturnable crop production chemical containers is drumMUSTER. It provides chemical users with a defined route to safely dispose of most used chemical containers. Eligible containers have the drumMUSTER re-use logo marked on them. Normally drumMUSTER collections are arranged by your local council. Contact them or your reseller to find out when the next collection is in your area.

Dispose of waste pesticides and containers thoughtfully to protect the environment.

a key issue



Safe storage, use and
disposal of pesticides
Chapter 4 page 230

Bird and animal pests

Mice in plague numbers can be a problem as they eat the seed soon after sowing, and can cause serious damage to cobs close to harvest. Check to see if your state has a current permit for the use of baits to solve this problem. Plants may be chewed off by ducks, hares, rabbits, wallabies or kangaroos. If hares, rabbits, wallabies and kangaroos are a problem, build a netting or electric fence around the perimeter of the block. A trail of dried blood around the block may work for a few days.

Wallabies, kangaroos and native birds are protected and cannot be trapped or destroyed without a permit. In Queensland, problems with these animals should be referred to your nearest Environmental Protection Agency (EPA) or the Queensland Parks and Wildlife Service (QPWS), the National Parks and Wildlife Service in NSW and in Victoria, the Department of Sustainability and Environment.

Not all birds in the crop will cause damage. Most will be eating insects, so are beneficial. A permit will only be issued after an inspection by an officer of the responsible department in your state. You must be able to show evidence of significant damage and that you have tried other deterrent methods. Scare guns and suspended hawk kites are used but may not be very effective.

Hares and rabbits are not protected. Figure 15 is a diagram of an electric fence designed to keep hares and rabbits out of crops.

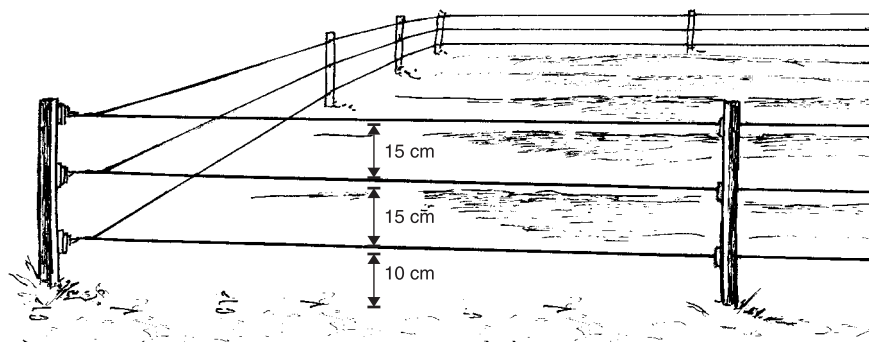

Figure 15. A diagram of an electric fence to exclude hares and rabbits from crops

Control weeds

Cultivation and/or herbicides may be used to control weeds. Cultivation is generally restricted to the early growth period, within 20 to 40 days of planting, while tractors and implements are able to straddle the crop. Take care not to damage the plant roots. Once established, sweet corn is generally quite competitive provided weed growth is suppressed during early crop growth.

Table 24 lists post-emergent herbicides registered for use in sweet corn. Carefully read the label before use to check application rates and specific recommendations for use. Remember that many crops are very susceptible to drifts of hormone herbicides such as 2, 4-D.

Table 24. Post-emergent herbicides

Chemical	Comments
2,4-D	Controls broadleaf weeds. DO NOT allow to drift onto other crops.
atrazine	Needs rain or irrigation within 10 days of application. For grass and broadleaf weed control. For post-emergent applications, add a crop oil at 5.5 L/ha. Ensure that it will not have a residual effect on the following crop.
cyanazine	Tasmania only. May be applied as a very early post-emergence treatment up to 4 leaf stage. Application should be timed to coincide with moisture.
diquat	Controls broadleaf weeds. Shield the nozzle to stop drift. Use where broadleaf weeds predominate.
fluroxypyr as mhe	Apply when secondary roots are present, from 3 fully expanded leaves (10 cm tall) up to just before tasselling. From the 6 leaf stage to just before tasselling, use dropper nozzles to prevent the herbicides coming in contact with the crop's leaves and the growing point (meristem). Controls broadleaf weeds.
linuron	Apply as directed band spray to each side of the row when crop is 30 to 40cm high. DO NOT use a misting machine. Avoid spray contact with crop foliage as injury may result. DO NOT replant treated areas to other crops within 3 months of application. If weeds are present add a wetting agent at the label rate.
MCPA-sodium	Apply when crop is 10 to 20 cm tall. DO NOT cultivate soon after spraying as crop may be brittle. Controls broadleaf weeds.
paraquat	Controls grasses and broadleaf weeds. Shield the nozzle to top drift.



Figure 16. A well-hilled crop

Hilling

The crop can be hilled during inter-row cultivation to assist in weed control. Do not cultivate where a pre-emergent herbicide (for example atrazine or metolachlor) has been used, as cultivation will disturb the herbicide layer making it less effective.

However, if you are going to hill-up, a split application of herbicides can be made. A pre-emergent application of atrazine, atrazine plus metolachlor, or S-metolachlor can be followed by a post-emergent application of atrazine after hilling-up to prevent weed growth in the cultivated soil. Ensure that the total rate of atrazine applied in any one season does not exceed 3 kg/ha.

Hilling the crop is not necessary for successful production but assists in reducing crop lodging. Figure 16 shows a well-hilled crop.

Manage plant nutrition

Additional fertiliser will be required as the crop develops. Up to 60% of the nitrogen required by the plant is taken up in the two weeks before and two weeks after tasselling. It is essential that the plant has adequate nitrogen once silking commences or tip fill will be affected.

The application of fertiliser every few weeks without knowing whether plants require it is wasteful and environmentally irresponsible. Take the guesswork out of fertiliser applications by monitoring plant nutrient levels.

Plant nutrient monitoring

Leaf testing is a benchmarking tool that has little direct relevance to the current crop. Its value is in judging the effectiveness of the fertilising schedule used in this crop and how it may be improved for the next crop. Use the results of soil and leaf testing to refine the fertiliser schedule for the next crop.

Do a leaf analysis at the tasselling to initial silk stage. Buy a tissue sampling kit from your farm supply outlet and follow its instructions. The laboratory analysing your sample will interpret the results and advise what nutrients are needed.

Sap testing is a means of rapidly assessing a plant's nutrient status during crop growth. This test has a 24-hour turn-around time. It can be used to highlight deficiencies of essential elements or to monitor the nitrate and potassium levels during the crop cycle. Sap testing allows growers to manage the crop more precisely and to correct any nutrient problems before yield or cob quality are affected.



Nutrition
Chapter 4 page 141

The optimum levels for sweet corn for the ear leaf taken at the silk stage are shown in Table 46 in Chapter 4.



Plant testing services
Chapter 5 page 243

You can do the tests yourself, but we recommend you use a commercial sap testing service for the tests and advice get on the results.

The test involves collecting the youngest fully expanded leaf, extracting sap with a garlic press, and analysing its nutrient content. Sap testing may start when plants have five to six leaves and continue every two weeks to tasselling.

Sap testing for nitrogen, phosphorus, potassium, calcium, magnesium, boron and zinc should ideally be done every two weeks. Nitrogen, magnesium, boron and zinc are good indicators of the plants' nutritional health.

Apply side-dressings (post-plant)

Fertiliser applications should be based on the results of soil or plant nutrient analysis. If soil or plant test results are not available the fertilisers and rates in Tables 26 to 29 may be used as a guide.

Post-plant fertiliser can be drilled in beside the row at the last cultivation, broadcast over the crop using a spinner applicator or aircraft, or applied through the irrigation system (fertigation).

When, how and how much side-dressing fertiliser you apply depends largely on how you irrigate your crop. Tables are provided below for Queensland, NSW and Victoria. They give a general guide to the additional amount of nitrogen to apply to the crop as side-dressings. If potassium levels are low, additional potassium may also be required at this time.

If irrigation is being monitored with scheduling equipment and leaching of fertiliser is controlled, the post plant application may be reduced.

Fertilising through irrigation water (fertigation)

Fertiliser can be applied through overhead sprinklers, furrow irrigation (called 'water run') or drip irrigation systems, but most growers use an overhead system. Fertigation uses less labour than manual application of solid fertilisers. With these systems fertilisers can be applied more regularly and closer to the roots. Before fertigating, have a water testing laboratory analyse your irrigation water.

With drip and overhead fertigation, fertiliser is dissolved in water in a drum or tank and sucked or injected through the watering system. Fertilisers used must be highly soluble to avoid damaging the pump and blocking pipes. Suitable soluble fertilisers are listed in Table 25. There is also a range of soluble commercial fertiliser blends.

For fertigation with furrow irrigation, the dissolved fertiliser in the tank is metered into the top supply channel then syphoned down every

furrow. Urea is the most common product used. With this system there is less damage to equipment and fewer blockages as the soluble fertiliser does not have to go through pumps or filters.

Table 25. Fertilisers that can be dissolved in water for fertigation

Fertiliser	Elements applied	% of elements
Urea	nitrogen	46% N
Calcium nitrate	calcium, nitrogen	18.8% Ca, 15.5% N
Ammonium nitrate	nitrogen	34% N
Magnesium sulphate	magnesium, sulphur	9.6% Mg, 12.4% S
Potassium nitrate	potassium, nitrogen	38.3% K, 13% N
Potassium chloride	potassium, chlorine	50% K, 50% Cl
Potassium sulphate	potassium, sulphur	41% K, 18% S
MAP (mono ammonium phosphate, technical grade)	nitrogen, phosphorus	12% N, 26.6% P
MKP (mono potassium phosphate)	potassium, phosphorus	28.6% K, 22.8% P
Various soluble commercial mixtures	nitrogen, phosphorus, potassium, some with trace elements	Varies eg 21% N, 9% P, 16% K

Queensland

Side-dressing drip irrigated crops

Fertiliser is easy to apply through a drip irrigation system. Table 26 is a guide to nitrogen application rates through drip irrigation systems in Queensland. Make two applications of nitrogen fertilizer, one at the four leaf stage and one at early tasselling. If the soil is known to be very low in nitrogen, an additional application of nitrogen at 16 kg/ha can be made between the four leaf stage and tassel emergence.

Where additional potassium is required, it can be supplied as potassium nitrate (KNO₃) or as a soluble mixture of, for example, N:P:K – 21:9:16.

Table 26. A guide to side-dress applications for drip irrigated crops in Queensland

Nutrient	Plant stage	Amount of N (kg/ha)	Amount of K (kg/ha)	Rate (kg/ha)			
				Urea (46% N)	Nitram (34% N)	Soluble N:P:K (21:9:16)	KNO ₃ (13:0:38)
Nitrogen	4 leaf stage	30	–	65	88	–	–
	intermediate (optional)	16	–	35	47	–	–
	early tassel emergence	30	–	65	88	–	–
Nitrogen & potassium	4 leaf stage	30	23	–	–	143	–
	Intermediate (optional)	16	46	–	–	–	123
	early tassel emergence	30	23	–	–	143	–

Side-dressing overhead or furrow (flood) irrigated crops

For furrow irrigation, drill into the irrigation furrow before watering. Drill in beside the row or broadcast over the crop using a spinner applicator or aircraft if using overhead irrigation.

Fertiliser can be applied in one or two applications. If making only one application, apply it at the latest stage you can drive over the crop. For two applications, apply the first one at the four-leaf stage and the second at the latest stage you can drive over the crop. Table 27 is a guide to side-dressing fertiliser requirements in Queensland.

Table 27. A guide to nitrogen application for overhead or furrow irrigated crops in Queensland

Fertiliser	Rate of fertiliser per application		
	1 application	2 applications	
		first application	second application
Urea	130 kg/ha	65 kg/ha	65 kg/ha
OR			
Ammonium nitrate	176 kg/ha	88 kg/ha	88 kg/ha

New South Wales

In NSW it is common practice to make the first side-dressing fertiliser application with a cultivation at the latest stage you can drive over the crop, about the six to eight leaf stage. Growers then fertigate, water running nitrogen by furrow, or applying it through centre pivot irrigators in several small amounts until early tassel emergence.

When travelling irrigators are used, a single application is drilled in at the six to eight leaf stage, then watered in with the travelling irrigator.

Total nitrogen requirements for the Sydney Basin and the Central West are similar with about 220 kg/ha total nitrogen required throughout the growing season. To ensure high yields in the Riverina, growers need about 250 kg/ha total nitrogen. Higher nitrogen requirements are needed in the Riverina due to the irrigation method, soil fertility and inefficiencies in nitrogen uptake. Table 28 is a guide to side-dressing fertiliser requirements in New South Wales.

Central West. If travelling irrigators are used only one application is made at the six to eight leaf stage. If using centre pivots, one initial application is made, then several more as needed, up to the early tassel emergence stage.

Riverina. If using furrow irrigation, one large application is made with the final cultivation at the six to eight leaf stage, then water run as needed up to the early tassel emergence stage.

Table 28. Nitrogen application for overhead or furrow irrigated crops in NSW

District	Irrigation method	Time of application	Fertiliser applied	Number of applications	Quantity to apply (kg /ha)	Total applied (kg /ha)
Central west	travelling irrigator	6 – 8 leaf stage	urea	1	174 – 217	174 – 217
	centre pivot	6 – 8 leaf stage	urea	1 plus	65	65
		up to early tasselling	urea	several	110 divided by the number of applications	110
Riverina	furrow	6 – 8 leaf stage	urea	1 plus	150	150
		up to early tasselling	urea	several	110 divided by the number of applications	110

Victoria

Side-dressing applications should be based on a soil test, previous cropping history or a sap test. Apply around 110 kg/ha of nitrogen as one or more side-dressings. Start side-dressing about 30 days after emergence when the rapid growth stage begins and have all side-dressings applied by early tasselling. If the level of potassium in the soil is low a side-dressing of up to 500 kg of a 20:0:16, N:P:K mixture may be a better alternative. Table 29 is a guide to side-dressing fertiliser requirements in Victoria.

Table 29. A guide to nitrogen application for overhead or furrow irrigated crops in Victoria

Time of application	Fertiliser applied	Number of applications	Total applied (kg /ha)
30 days after emergence	urea	1 or more	200 kg/ha
	OR		
30 days after emergence	calcium ammonium nitrate (CaNO ₃)	1 or more	300 kg/ha
	OR		
	potassium nitrate (KNO ₃) (if potassium is low)	1 or more	300 kg/ha
	OR		
30 days after emergence	20:0:16		up to 500 kg/ha

Other major elements

Other major elements (for example calcium, magnesium and sulphur) may also be deficient in some soils at times and may need to be corrected.

Trace elements

Apply trace elements if deficiencies have developed in previous crops or where soil or leaf analyses results suggest a possible deficiency. Do not exceed the rates suggested here. The addition of urea at 500 g/100 L of



water will increase the leaf's absorption of trace elements. Only spray to wet the leaves, not to have runoff, otherwise leaf damage may occur. Solution concentrations greater than 1% are likely to cause leaf burn. Apply foliar nutrients separately, not combined with pesticide sprays. Table 30 gives the application rates to control boron and zinc deficiencies.

Table 30. Application rates for boron and zinc

Element	Product	Rate	Comments
boron	Solubor (20.5% B)	250 g/100 L	Foliar spray, 2 to 3 applications 2 weeks apart starting 2 weeks after emergence. Do not exceed a total of 2.5 kg/ha. Solubor is not compatible with zinc sulfate heptahydrate.
zinc	zinc sulfate heptahydrate	200 – 250 g/100 L	Foliar spray, 3 to 4 applications 1 week apart starting 1 to 2 weeks after emergence. Do not apply on very hot days or in the middle of the day. Do not mix with boron.
	Zincsol (16.7% Zn)	2 L/ha	Apply as a foliar spray or with irrigation.

Foliar fertilisers

Foliar fertilisers contain soluble nutrients, which are sprayed on the crop and absorbed through the leaves. They may be urea or potassium nitrate dissolved in water, specific trace elements or a 'shotgun' mixture of many major and trace elements.

As plants absorb nutrients mainly through the root system, foliar fertilisers should not be used to replace soil applications. However, where specific trace element deficiencies have been identified, or disease or waterlogging has rendered the roots ineffective, foliar fertilisers may help the plants survive until new roots develop and can again provide support.



Tasselling to the end of silking

This stage usually takes 13 to 20 days. There are five important things to manage during this stage.

- Monitor soil moisture and irrigate
- Manage pests and diseases
- Control weeds
- Manage plant nutrition
- Pollination

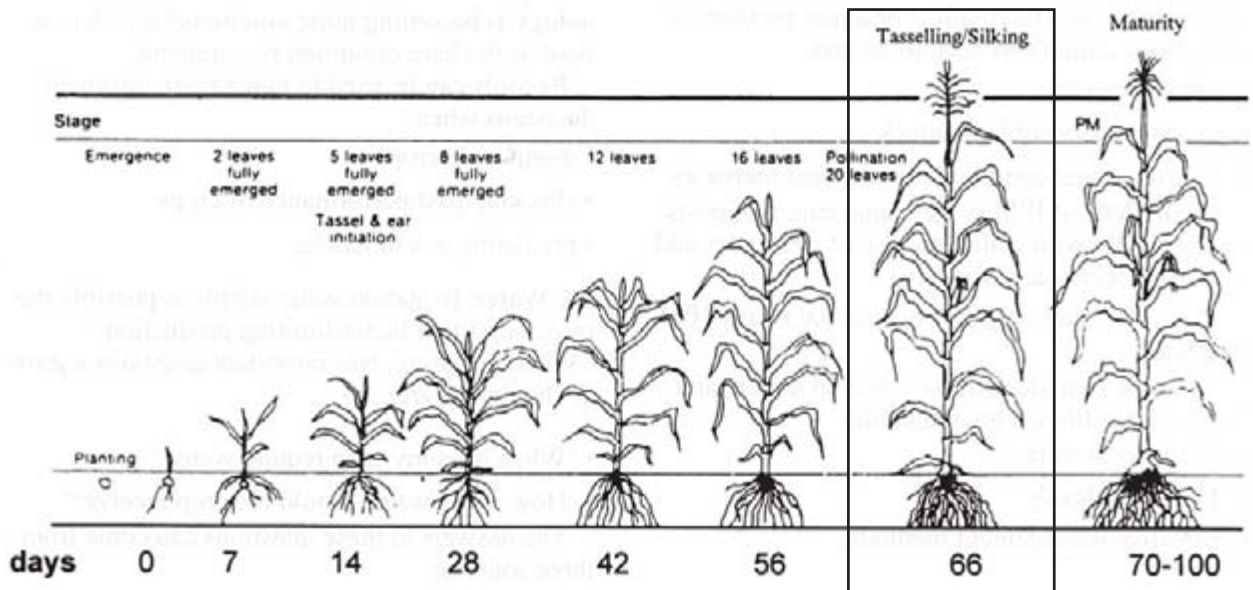

Figure 17. The frame indicates tasselling to the end of silking. (Source: 'Growing sweet corn'. Agfact H8.1.39)

more info



Crop management handy guide Chapter 6

An understanding of the plant's growth cycle will help with crop management.

Monitor soil moisture and irrigate

Critical times for irrigation are tasselling, silking and cob fill. Moisture stress can lead to poor pollination resulting in blanking. Do not allow the crop to stress. When using tensiometers, Table 31 is a guide to when to irrigate during this stage. Tensiometers should not remain below 10 centibars except just after irrigation.

Table 31. Shallow tensiometer reading at which to commence irrigation during the tasselling to end of silking stage

Soil type	Tensiometer reading
Sandy loams	35 – 40
Clay soils	40 – 50

Manage pests and diseases

Monitor crops frequently enough to make good management decisions. This should be at least twice a week from tasselling to harvest.

Monitoring

From the start of tasselling, concentrate on the tassels and then the silks when they appear until they brown off, after which intensive monitoring is no longer required.

Heliothis (corn earworm) is the major pest of sweet corn at this stage. Armyworm, aphids, mites, thrips, sorghum head caterpillar, redshouldered leaf beetle and dried fruit beetle may also cause problems at this stage.

Monitor also for turcicum leaf blight and rust.

Heliothis (corn earworm)

For the fresh market trade, sweet corn must be free of heliothis larvae and their damage. Slight damage to the upper silk can be trimmed off before marketing. Some damage is tolerated for processing but, with the exception of the sweet corn nibblet trade, damage to the grains should not extend beyond the tip of the cob.

Some varieties of sweet corn are less susceptible to heliothis damage than others. However with such high standards demanded by the market, all varieties require frequent monitoring of pest levels during the green silking period. Monitor at least twice a week or more frequently depending on heliothis activity and egg laying pressure.

The critical point for control is from when the first trace of the green silks can be seen until the death of the silks. If pesticide application is delayed or missed during periods of high heliothis activity, control will be ineffective.

Control weeds

Further weed control should not be necessary at this stage. Rogue out large weeds before they seed.

Manage plant nutrition

All side-dressings and foliar nutrient sprays should have been applied before tasselling.

The causes and possible solutions along with colour photos of problems with insects, mites, diseases and disorders, can be found in the companion book available from DPI&F offices—

PICTURE GUIDE:

Sweet corn problem solver & beneficial identifier

Pollination

Sweet corn is wind pollinated, bees are not required, however bees can often be seen gathering pollen from sweet corn crops. To protect bee populations from harmful pesticides, spray in the late afternoon or evening when bees are not foraging.

Supersweet varieties must be separated from normal sweet corn or maize crops by more than 200 m to prevent cross-pollination that results in starchy sweet corn.

It is also possible to separate crops by planting at different times so that silking of the supersweet variety does not coincide with pollen shedding from normal sweet corn or any other type of maize crops. Allow a 14 to 21 day gap between plantings to avoid cross-pollination.



End of silking to harvest

This stage usually takes 12 to 18 days. There are three important things to manage during this stage.

- Monitor soil moisture and irrigate
- Manage pests and diseases
- Control weeds

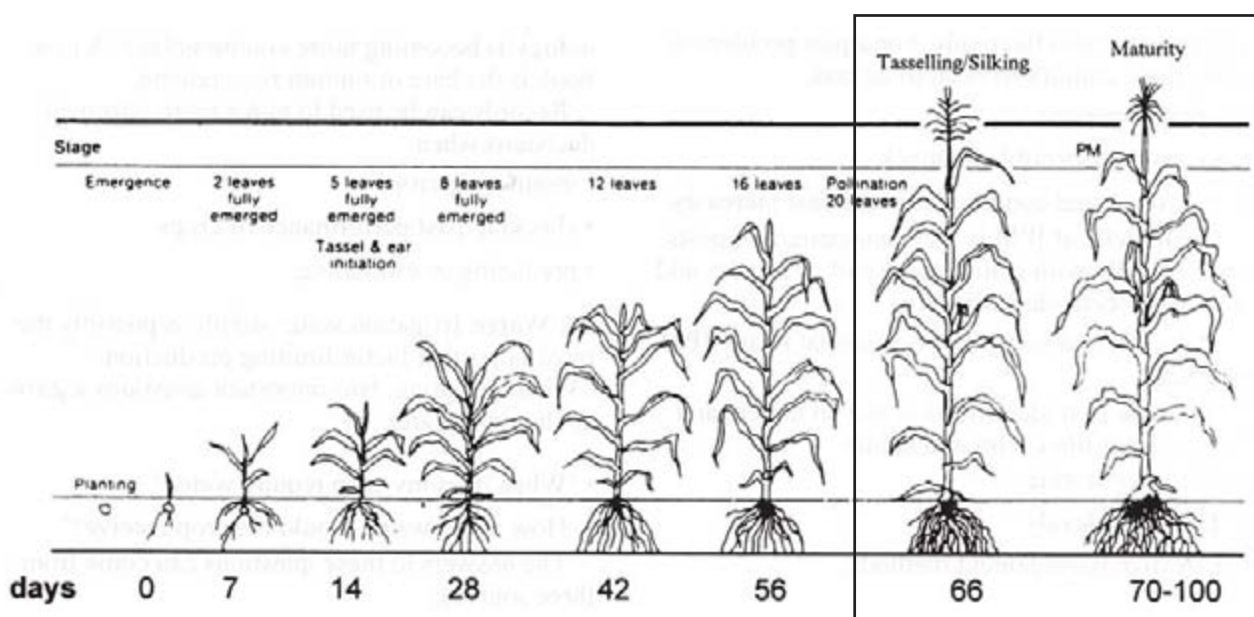

Figure 18. The frame indicates the end of silking to harvest. (Source: 'Growing sweet corn'. Agfact H8.1.39)

more info



Crop management
handy guide
Chapter 6

An understanding of the plant's growth cycle will help with crop management.

Monitor soil moisture and irrigate

Do not allow the crop to stress for water. When using tensiometers, Table 32 is a guide to when to irrigate during this stage. The tensiometer should not remain below 10 centibars except just after irrigation.

Table 32. Shallow tensiometer reading at which to commence irrigation from the end of silking to harvest

Soil type	Tensiometer reading
Sandy loams	35 – 40
Clay soils	40 – 50

Manage pests and diseases

Monitor crops frequently enough to make good management decisions. This should be at least twice a week from tasselling to harvest.

Monitoring

From the brown silk stage until harvest, monitor for heliothis, aphids and thrips, particularly if cobs are destined for the export market. Other pests may include mites, yellow peach moth, sorghum head caterpillar, green vegetable bug and dried fruit beetle.

Boil smut, turcicum leaf blight and rust can all affect the crop at this stage and reduce marketable yield.

Parrots and mice can sometimes destroy cobs in field. Generally no remedial action is possible with wildlife damage.

Control weeds

Further weed control should not be necessary at this stage. Rogue out large weeds before they seed.



Harvesting, handling and marketing

Sweet corn must be harvested, handled and marketed with care as the price you receive for your crop depends largely on appearance and quality. There are nine important steps in this process.

- Harvesting
- Postharvest handling
- Grading and packing
- Packaging
- Mark packages
- Cooling
- Transport
- Storage
- Marketing

Harvesting

Depending on variety and time of year, cobs will be ready for harvest from approximately 60 days to 120 days after planting, but usually in the 80 to 95 day range.

In north Queensland, fresh market yields can vary from around 600 to 1300 x 18 L packages per hectare. The average over a season is around 950 packages per hectare.

In other areas fresh market yields can range from 800 to 1500 18 L packages per hectare. Average yields are around 1000 packages per hectare. Crops grown for processing will produce average yields of 17 t/ha in Queensland and 12 to 24 t/ha in NSW with an average of 17 t/ha. Export corn is sold on a per cob basis.

Baby corn is harvested at the stage when the tips of the silks are just visible and the cobs are 4 to 10 cm long and 1 to 1.5 cm in diameter.

Based on 110 000 plants per hectare for baby corn production and an average of three cobs per plant, the yield would be 270 000 cobs per hectare, around 2.2 t/ha of husked baby corn.

Assess maturity

Sweet corn should be harvested at the milk stage to obtain a sweet product with tender kernels. The age of the kernel at harvest has a major impact on the total percentage of carbohydrate (sugar and starch) in



Maturity testing
Chapter 4 page 130

maize and normal (su) sweet corn, but far less impact in supersweet (sh₂) sweet corn (Table 33). The higher the temperature, the shorter time the kernels remain in good edible condition.

The milk stage is indicated by the slight drying and browning of the silks and the plumpness of the ear when grasped in the hand. Pull the husk back on a few ears to test the accuracy of the picker's judgement. Sweet corn maturity can be determined rapidly using a microwave drying technique, however this is mainly used by processors.

Table 33. Carbohydrate content in corn endosperm at four harvest stages

Genotype	Kernel age (days)	Total sugar (%)	Starch (%)
Maize	16	18	39
	20	6	66
	24	5	69
	28	3	73
Normal (su) sweet corn	16	26	23
	20	16	28
	24	13	29
	28	8	35
Supersweet (sh ₂) sweet corn	16	28	22
	20	35	18
	24	29	20
	28	26	22

Source: Creech, R.G. 1968

Fresh market crops

Cobs are ready to harvest approximately three to four weeks after the crop is at the 50% silk stage and when the kernels at the tip of the cob are 75% full. Kernel moisture content should be 76 to 80% at optimum maturity.

Processing crops

Normal (su) varieties are ready for harvest at a moisture content of 72 to 74%, while supersweet varieties should be harvested at 76 to 79% moisture. The kernel will be at the full milk to very early dough stage.

In cool, moist conditions the crop matures slowly and quality will not be greatly affected if harvesting is delayed two to four days. However in hot, dry weather, moisture can drop rapidly and sweet corn must be harvested within 24 hours of reaching 72% moisture.

Sweet corn for freezing should be harvested at 72% moisture. At 70 to 71% it is suitable for canning as whole kernels and from 68 to 70% for creamed corn. Processors rarely use sweet corn with a moisture content below 68%.

Harvesting techniques

Avoid harvesting in the heat of the day. Night or early morning is the best time to harvest when the field heat is lowest. Harvesting for the fresh market can be done by hand or by machine, usually as a once-over harvest.

Hand harvesting

When hand harvesting, either use a sharp knife to remove the cob from plant or twist the cob and break it from the stem. Feeling the cob by hand will give a good indication of maturity, particularly where second cobs are available on the plant. Generally, crops are only harvested once and all mature cobs are taken.

Machine harvesting

Machine harvesting of fresh market sweet corn is common with machines harvesting one to four rows at a time (Figure 19). All processing crops are machine harvested with four or six-row harvesters (Figure 20). Sweet corn from the harvester is collected in paddock bins then taken to trucks for transport to the factory.



Figure 19. A four-row fresh market harvester

Check that cobs are not being cut or bruised because the cutter has been set at the wrong height.

Figure 20. A six-row processing harvester



Postharvest handling

Fresh market sweet corn cobs are loaded into bulk bins or large tipping bin trailers in the field (Figure 21). They are then transported to the shed

for packing and cooling as quickly as possible to avoid cob quality deterioration due to moisture loss. Sweet corn has a high respiration rate and will deteriorate rapidly if not cooled quickly.

The best practice is to hydro-cool bulk bins to lower the core temperature of cobs to 0°C before packing. This will arrest deterioration of the product before packing.

Processing crops are harvested into large bins on tipping trailers (Figure 22) that are then transported to the factory for immediate processing. Processing crops must be grown fairly close to the factory.

Postharvest diseases and disorders

Kernel fermentation can sometimes be a problem. Individual kernels may break down, often after heavy rain. This is usually detected during harvest and affected fresh market cobs can be rejected during packing.



Figure 21. A tipper bin



Figure 22. A tipping trailer and large bins

Grading and packing

Handling fresh market sweet corn in the shed involves cutting the shank off the butt of the cob, inspecting for grub damage and hand packing into polystyrene containers. Figure 23 shows a well packed container of sweet corn. Do not cut too much shank off or you will lose too many wrapper leaves that protect the cob. Grade cobs for uniformity of size and shape.

Cobs are sorted during the packing process. Feeling the cobs by hand gives a good indication of insect damage and poor cob filling. Small and damaged cobs are generally passed through a pre-packing line if this facility is available.

Whole cobs are packed with the wrapper leaves on the cob. Dark green wrapper leaves improve the presentation of whole cobs. It is important to keep as much as possible of the wrapper leaf on the cob after the shank



Figure 23. A well packed container of sweet corn



Figure 24. A polystyrene container of pre-packs

(butt end where the cob attaches to the stalk) has been removed from the cob. Not all varieties have 'flags' on the wrapper leaves.

Pre-packs

Where pre-packing lines are installed, most of the husk is usually still left on the cob, however a 2 to 3 cm wide strip of husk is removed from the top side of a cob. This allows cobs to be inspected for damage and quality. Grub damaged cobs may have the tips cut off to remove damaged cob and be packed into pre-packs (usually three per pack, Figure 24). This increases marketable yields. The minimum acceptable length of useable cob is approximately 125 mm.

Grade standards

To meet both the agents' and consumers' expectations, sweet corn should be prepared so it will arrive at the final destination in a satisfactory condition. Many of the major buyers are developing their own standards, so if you are supplying several buyers, grade to the strictest standard set.

To present an attractive pack, grade so packages contain even sized cobs. Second grade cobs should be packed into pre-packs. The 18 L package holds about 9 kg (around 24 to 30) whole cobs, or around 40 pre-packed cobs.

Size is indicated by the count, that is the number of cobs per package. A count of 24 or 30 in an 18 L package indicates large cobs, as the count increases, for example 42, the size of cobs decreases. The most popular size is a count of around 30 cobs per 18 L package.

Although grade standards are no longer legally in force for domestic markets, the following is a guide to what the market has come to expect.

- ‘Sweet corn’ means cultivars derived from *Zea mays* var. *rugosa* known as sweet corn but does not include cultivars used as field corn, maize or pop corn.
- ‘Mature’ means that the kernel is fully developed in size and that a milk-like juice exudes from the kernel when ruptured.
- ‘Over mature’ means that the kernel is firm and does not exude a milk-like juice when ruptured.
- ‘Dimpling’ refers to the end of the kernels being sunken. This is the result of age or moisture loss. Dimpling is the main indicator that the cob is old or stale.
- Sweet corn shall consist of clean, sound, fresh cobs of sweet corn of similar varieties. The kernels shall be plump, mature and developed along at least 90% of the length of the cob, but not over mature or shrivelled.

Quality assurance for sweet corn

Marketing and quality management is a vital step in sweet corn production. How well you manage this, and the quality of your product, will have a considerable effect on whether you make a profit or loss from your production.

Sweet corn growers are implementing quality management systems driven by customer demand and food safety legislation.

Packaging

Fresh market sweet corn is normally marketed in polystyrene packages. This facilitates the use of hydro-cooling, the most common pre-cooling method used. Hydro-cooling involves passing chilled water over the sweet corn, either in the field bins before packing, or in the containers in which it is to be marketed. Vacuum cooling is also used. Where these cooling facilities are not available, room cooling followed by top-icing can be used with polystyrene containers. In some areas fibreboard cartons are used, however these packages can not be hydro-cooled.

Pre-packed sweet corn on polystyrene trays covered with clear film must be cooled in cool rooms as hydro-cooling is not applicable after packing.

Packages printed with your own brand and colour scheme make it easier for buyers to identify your product in the wholesale markets.

Price Look Up (PLU) numbers

Price Look Up (PLU) numbers commonly used on most products sold through major retail chains have been introduced for fruit and vegetables. These numbers assist checkout staff in identifying and correctly



Marketing and quality
management
Chapter 4 pages 98, 103

pricing products. There are PLU numbers assigned to a range of sweet corn types.

Palletising

Palletising reduces handling of individual packages of sweet corn. The 18 L polystyrene packages have been designed to fit on an Australian Standard Pallet. This pallet is usually stacked with 72 or 80 of the 18 L packages, that is nine or 10 layers with eight packages per layer.

When making up pallets it is best to stack a similar size and variety on individual pallets. This is known as unitising and makes handling in the market chain easier.

When loading a pallet it is most important that all packages are fitted squarely on to it and that the air vents of each layer of packages face the same direction, to allow the maximum air flow through the stack. Pallet stacking aids assist with this operation. The stack is held together by corner stays and strapped, taped or wrapped with stretch nylon netting. The pallet is designed to be moved using fork lifts or pallet jacks. A pallet hire pool operates in most districts.

Mark packages

Every package of sweet corn must be marked with the following legible information, durably stamped stencilled or printed on at least one end of the package. Failure to do this may result in prosecution.

- The name and full address (including the state) of the packer, the grower or person responsible for packing or the registered brand on whose behalf it was packed. The address must give enough detail for the person to be identified and located. A post office box number or mail service is not acceptable but can be included with the other information.
- The words 'sweet corn'.
- The count of cobs or net weight in the package.

This information must also be placed on individual pre-packs. The minimum print height should be 2 mm for packages with a maximum dimension up to 120 mm and 2.5 mm from 120 to 230 mm.

Printing on packages should have a minimum letter height of 5 mm. Failure to correctly mark the package may result in product being withheld from sale until correctly marked.

Unless pre-printed, sweet corn packages will have a panel with space for you to stamp or stencil your name and address, and details of your

wholesale agent. Space for the count and a traceability code is usually included for you to tick or circle the appropriate box. An example of a package end panel is shown in Figure 25.

SWEET CORN		THE SWEET CORN FARM	
TYPE		GROWN & PACKED BY: The Sweet Corn Farm 275 Long Road BUNDABERG QLD 4670	IP No. Q 0111
Supersweet	<input checked="" type="checkbox"/>		Reg. No. 2543
Normal	<input type="checkbox"/>		CLASS 1
COLOUR		CONSIGNED TO: as per consignment note	Net Wt. 8 kg
Gold	<input checked="" type="checkbox"/>		Count
Bi-colour	<input type="checkbox"/>		
White	<input type="checkbox"/>		
			ABCD EFGHIJKLMN OPQRSTUVWXYZ
PRODUCE OF AUSTRALIA			

Figure 25. End panel labelling for a package of sweet corn

Cooling

Sweet corn deteriorates very rapidly in high temperatures and should be marketed immediately after picking. Pre-cooling of the cobs to 0°C and 95 to 100% relative humidity prevents the rapid loss of sugars.

Cooling methods

Consult a refrigeration engineer when designing cooling facilities. The engineer will need details of:

- maximum volume and weight of product;
- time required to cool the product;
- type of container the product will be packed in;
- maximum temperature of the product at the time of placing in the cold room;
- minimum temperature to which product will be cooled.

There are three common ways to cool sweet corn, hydro-cooling, vacuum cooling and forced air cooling.

Transport

Sweet corn is sometimes top-iced in polystyrene packages after cooling to keep it cool whilst in transit. Use refrigerated trucks to transport sweet corn to market to help keep cobs cool. All products in the truck should be pre-cooled before loading.



Postharvest temperature management
Chapter 4 page 235

Sweet corn transports well in refrigerated trucks as a mixed load with other vegetables. It suffers no ill effects from the ethylene produced by some crops during transport and sweet corn produces little ethylene.

Transport sweet corn in refrigerated containers at 0° to 2°C. Avoid stabilising sheets placed through the load. These sheets prevent air movement through the load, particularly if the packages are not palletised.

Refrigeration systems in rail wagons and road transports are designed to maintain temperature, not to cool fruit and vegetables. Print-out temperature recorders should be fitted to all refrigeration containers.

The *Code of practice for the road transportation of fresh produce 1996 /2000* is a guide to road transport.

Sweet corn for processing is transported immediately after harvest by trucks with large mesh trailers. The trailers are purpose built for transporting sweet corn to the processors.

Storage

Careful management of temperature is critical to maintain the quality of sweet corn. Under ideal conditions (humidity 95–100% and storage temperature at 0°C) sweet corn may be stored without significant loss of quality for 4 to 8 days. However, quality rapidly deteriorates if cobs are allowed to return to room temperature. Table 34 shows sweet corn shelf life, based on its percentage sucrose (sugar) for normal (su) and supersweet (sh₂) at two temperatures.

Table 34. Sweet corn shelf life at two temperatures based on percent sucrose

Temp°C	Hours from harvest					Sweet corn genotype
	0 hrs (at harvest)	24 hrs	48 hrs	72 hrs	96 hrs	
4°C	14.4	10.0	12.0	11.0	9.9	su
	36.5	32.0	31.0	32.0	33.0	sh ₂
24°C	14.4	5.7	5.0	3.5	2.4	su
	36.5	29.0	27.0	21.0	13.5	sh ₂

Source: Garwood et al (1976)

It is important to maintain a high humidity (95 to 100%) in cooling and storage to prevent desiccation of wrapper leaves and kernels. A hydro-cooling process helps to achieve this.

The Australian United
Fresh Transport Advisory
Council Ltd
www.auftac.com.au



Postharvest temperature
management
Chapter 4 page 235

Marketing

There are many options for marketing fresh market sweet corn. These include selling:

- to a local merchant;
- to an agent or merchant at the major markets;
- direct to a retailer, for example the major supermarkets or smaller retailers;
- overseas, either direct to buyers or through an exporter.

Know your market

To know your market, talk to people who are in constant contact with it, that is your agent/wholesaler and your retailer. Maintain a good relationship with your wholesalers and keep them informed of the quantities of produce you are consigning and the standard (quality) of the produce. Ask for feedback on the quality of your sweet corn in the marketplace. To provide what they want you will need to have a quality management program.

Domestic markets

Sydney is the largest market for sweet corn, followed by Brisbane and Melbourne. Adelaide is a rapidly developing market while Perth is absorbing increased quantities. Other provincial markets such as Newcastle, Townsville and Griffith all absorb significant quantities of sweet corn.

Sweet corn is usually sold in the wholesale markets through an agent or merchant. Agents sell produce for a commission, merchants buy the produce from the grower at an agreed price, then sell it on their own account.

Wholesale agents are your source of market intelligence, so your choice of a wholesale agent is extremely important. Seek advice on selecting wholesale agents from your local growers' association. If possible, at least once a season, visit the major market in which your crop is sold.

Major retailing chains are important outlets for sweet corn. Although some of their requirements are met from market supplies, they commonly also buy direct from growers. This is direct selling and is usually on the basis of an agreed pricing system and some form of quality assurance system.



Market information
Chapter 5 page 245

Where to buy *Export Control (Fresh fruits and vegetables) Orders, Schedule 1*, Chapter 5 page 253

Plant health contacts in each state
Chapter 5 page 248

Prices

Prices are closely tied to supply, with higher prices paid during periods of lower production, especially if it coincides with a period of high demand. Price is also influenced by quality, poor quality will receive a lower price.

Levies

There is a national levy for research and development of 0.5% of the value of domestic, export and processing product. This levy is collected at the first point of sale by the Levies Revenue Service, part of the Australian Government Department of Agriculture, Fisheries and Forestry on behalf of Horticulture Australia Limited (HAL) and distributed to AusVeg.

Marketing overseas

Generally no restrictions on export of sweet corn exist provided normal phytosanitary requirements are met. Currently most sweet corn is exported from Victoria.

The Commonwealth of Australia prints *Export Control (Fresh fruits and vegetables) Orders*, which show the requirements for exporting fresh produce. As there is no specific Schedule for sweet corn, *Schedule 1* of these orders should be used as a guide to the requirements for exporting sweet corn to other countries. The packages must be marked with the grower or packer's name and address, and 'Produce of Australia'. The product must meet any description marked on the package.

Produce for export to countries that require a Phytosanitary certificate, may be grown and packed in an on-farm Registered Export Establishment (REE) or prepared for export in a premises which has current REE status for the commodity being exported, for example fresh fruit and vegetables.

Protocols have been established with certain countries (New Zealand and Japan) to access those markets. These guidelines are commodity specific and have been established for the product, within the protocols, from growing through to export. However sweet corn exported to Japan is usually fumigated on entry. Produce exported to non-Phytosanitary certificate countries must, at some stage within the export process, travel through a REE. This may be a packing shed, exporters' premises or a freight forwarder.

Some countries require exporters to obtain an import permit before export. This permit specifies the latest requirements for that country.

The Australian Quarantine and Inspection Service (AQIS) supervises registration of establishments and issues phytosanitary certificates. Quarantine requirements vary between countries and intending exporters should keep informed through local AQIS offices.

Processing

Sweet corn crops may be contract grown for processing. Golden Circle Pty Ltd are currently the only processors active in Queensland. There are several processors in New South Wales including Simplot and Parle Foods. For processing, you grow the crop according a pre-determined schedule, and the processor determines when to harvest and does the harvesting.

Interstate quarantine requirements

Interstate requirements are subject to change so contact your local plant health inspector. Plant health coordinators can assist businesses with inspection services and arrange for property freedom accreditation. Growers are advised to confirm the details of requirements and fulfil them well before sending sweet corn interstate.

There are no restrictions on the movement of sweet corn within Queensland. Victoria has restrictions on the movement of sweet corn seed. Western Australia and Tasmania both have restrictions on the import of sweet corn.

