

# Low chill stonefruit information kit

Reprint – information current in 1998



## REPRINT INFORMATION – PLEASE READ!

For updated information please call 13 25 23 or visit the website [www.deedi.qld.gov.au](http://www.deedi.qld.gov.au)

This publication has been reprinted as a digital book without any changes to the content published in 1998. We advise readers to take particular note of the areas most likely to be out-of-date and so requiring further research:

- Chemical recommendations—check with an agronomist or Infopest [www.infopest.qld.gov.au](http://www.infopest.qld.gov.au)
- Financial information—costs and returns listed in this publication are out of date. Please contact an adviser or industry body to assist with identifying more current figures.
- Varieties—new varieties are likely to be available and some older varieties may no longer be recommended. Check with an agronomist, call the Business Information Centre on 13 25 23, visit our website [www.deedi.qld.gov.au](http://www.deedi.qld.gov.au) or contact the industry body.
- Contacts—many of the contact details may have changed and there could be several new contacts available. The industry organisation may be able to assist you to find the information or services you require.
- Organisation names—most government agencies referred to in this publication have had name changes. Contact the Business Information Centre on 13 25 23 or the industry organisation to find out the current name and contact details for these agencies.
- Additional information—many other sources of information are now available for each crop. Contact an agronomist, Business Information Centre on 13 25 23 or the industry organisation for other suggested reading.

Even with these limitations we believe this information kit provides important and valuable information for intending and existing growers.

**This publication was last revised in 1998. The information is not current and the accuracy of the information cannot be guaranteed by the State of Queensland.**

This information has been made available to assist users to identify issues involved in low chill stonefruit production. This information is not to be used or relied upon by users for any purpose which may expose the user or any other person to loss or damage. Users should conduct their own inquiries and rely on their own independent professional advice.

While every care has been taken in preparing this publication, the State of Queensland accepts no responsibility for decisions or actions taken as a result of any data, information, statement or advice, expressed or implied, contained in this publication.










Queensland Government









# Key ISSUES

*This section contains more detailed information on some of the important decision making areas and information needs for low chill stonefruit. The information supplements the growing and marketing recipe in Section 3 and should be used in conjunction with it. The information provided on each issue is not designed to be a complete coverage of the issue but instead the key points that need to be known and understood. Where additional information may be useful, we refer you to other parts of the kit. Symbols on the left of the page will help you make these links.*

	Understanding low chill stonefruit	3
	Economics of production	9
	Planning the orchard layout	16
	Determining chilling units	25
	Selecting varieties	29
	Nutrition	33
	Irrigation and water monitoring	45
	Pruning and tree size control	56

# Key ISSUES

Contents ... *continued*

	Pest and disease management	68
	Netting	79
	Fruit thinning	87
	Manipulating flowering & fruiting	90
	Marketing & quality management	95
	Propagation	100



## Understanding low chill stonefruit

*The aim of growing low chill stonefruit is to produce a large crop of high quality fruit. To achieve this, it is essential to have a good basic knowledge of what governs fruit production and quality. Here are the important things you need to know:*

Annual cycle of low chill stonefruit trees .....	3
Implications for crop management .....	6

### **Annual cycle of low chill stonefruit trees**

---

#### **Vegetative growth**

The low chill stonefruit tree is a deciduous tree that produces leaves for one season only. Leaf growth is almost continuous, from budbreak in July to the beginning of leaf fall in April. However, there are two main flushes (periods of new shoot growth):

- **The spring flush from budbreak to late September.** The energy for this flush comes mainly from reserves stored in the tree from the previous autumn. Some also comes from early spring root activity. By November, this flush is maturing and starts returning energy reserves to the tree.
- **The summer flush during December/January.** This flush is fed from root activity and stored reserves from the spring flush. In healthy trees, this flush remains active, with leaves remaining on the tree until late April or early May. When leaves are preparing for leaf fall in late May or early June, stored energy is shunted back into the tree's wood and roots for storage over winter while the tree is dormant. This storage is often accompanied by a noticeable swelling of the trunk and superficial cracking of the bark.

#### **Root growth**

Root growth, like vegetative growth, is almost continuous from budbreak until leaf fall. Similarly, there are two main growth peaks, one in December/January after maturity of the spring growth flush and the other in July/August just after budbreak.

#### **Flowering**

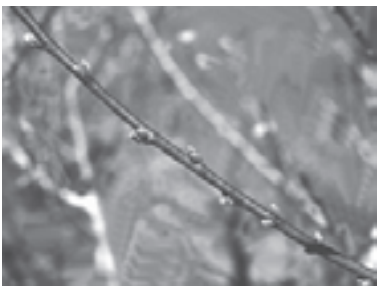
Flowers grow on laterals or spurs produced during the previous vegetative growth season. In healthy trees, flowers are initiated in

December/January with emergence or budbreak occurring during July/August. Flower buds break first, about a week ahead of leaf buds. The timing of budbreak depends on the chilling requirement of the variety and its sensitivity to temperature. Provided the chilling requirement has been met and the temperature rises above a certain threshold, budbreak can occur. This means that cold weather (to satisfy the chilling requirement) followed by warm weather (to promote growth) provides for an even and early budbreak.

Flowers of most low chill stonefruit are self-fertile (can be fertilised by their own pollen) and most set good crops without cross pollination from another variety. Exceptions are plums and the odd nectarine variety (for example Sunbob). In the self-fertile peaches and nectarines, most pollination is by wind movement and pollinating insects are helpful but not essential. In plums and Sunbob nectarine, where cross pollination is required, pollinating insects play an important role.

Flowers develop through a series of stages (Figure 1), some of which are important in the management of the tree. These stages are:

- dormancy — no activity
- budswell — buds become active and start to swell up
- budbreak (pink bud) — buds split open to show the tips of the petals
- full bloom — flowers fully open
- petal fall — petals wither and start to fall off
- shuck fall — petal fall complete and the dried-up remnants of the flower (shuck) still attached and ready to fall.



*Dormancy*



*Budswell*



*Budbreak (pink bud)*



*Full bloom*



*Petal fall*



*Shuck fall*

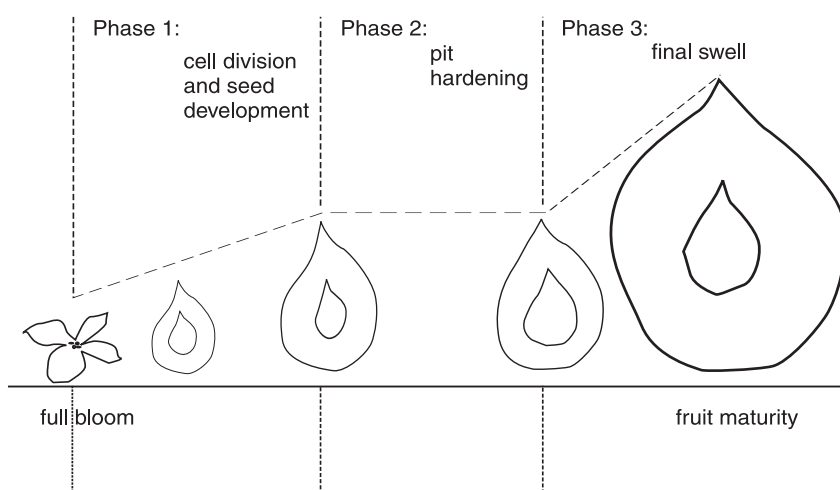
**Figure 1.** Stages of flower development

## Fruit development

Fruit develops through three main growth phases.

- Phase 1 is from fruit set to seed (stone) formation from early August to mid September. This is a period of rapid growth involving cell division where most of the fruit's cells are formed. The seed also starts to develop during this phase.
- Phase 2 is the main period of seed development and occurs from mid to late September, about 40 to 50 days after full bloom. The outer dimensions of the fruit change little. All the activity is within the seed (stone), which hardens and becomes crunchy.
- Phase 3 is from stone hardening to maturity. This is another period of rapid fruit growth where the fruit increases in size from enlargement of the cells in the flesh. The embryo in the seed also develops and matures during this phase. When the fruit is mature, it ripens from the tip upwards and from the inside to the outside.

An illustration of the phases of fruit growth is shown in Figure 2.



**Figure 2.** Phases of fruit growth

Fruit growth relies heavily on the energy reserves stored in the wood during the previous autumn. The period of fruit growth from blossoming to maturity varies with the variety and is called the fruit development period or FDP. The length of the FDP depends on temperature, particularly immediately after bloom for the first 30 or so days. Warmer temperatures satisfy the fruit growth heat requirement sooner and hence mature fruit more quickly. The most effective temperatures range from 15 to 30°C. An assessment of the FDP for a site can be made from climatic records. FDPs and chilling units for several typical low chill stonefruit sites are shown in Table 1.



Assesment of chilling  
This section page 25

**Table 1.** Fruit development periods (FDPs) and chilling units for various sites

Site	FDP (days)	Chilling units (1953–1996)		
		Average	Lowest	Highest
Mareeba	71	42	0	140
Bundaberg	82	157	63	256
Nambour	90	241	80	376
Kingaroy	97	451	191	704
Alstonville	92	245	76	340
Gatton	89	290	109	422

## Implications for crop management

Experience has shown that high performing trees follow a particular pattern of leaf growth, flowering and fruit development leading to a large crop of high quality fruit. The aim of crop management is to keep trees within this desired cycle by carefully managing fertilising, watering and other operations.

### Young, non-bearing trees

During the first one to two years, the aim is to grow a strong, healthy canopy of branches and leaves as quickly as possible. This involves several key management steps.

- Buy healthy trees from a specialist low chill stonefruit nursery. Ensure that the nursery is using virus-tested budwood and seed for rootstocks. Where possible, pre-arrange to receive trees at an appropriate stage of root development. Old, pot-bound trees have thick, matted roots which often poorly colonise the surrounding soil when planted out. When trees are received, check that the scion and rootstock are as ordered. Then check that the trees have good leaf colour, are free from pests and diseases and have been hardened to full sunlight.
- Ensure the trees get the best start by carefully preparing the planting site and using good planting technique.
- Provide optimum conditions for tree growth by supplying adequate fertiliser and water; controlling weeds, diseases and pests; mulching to create a better root environment; and minimising wind damage.

### Bearing trees

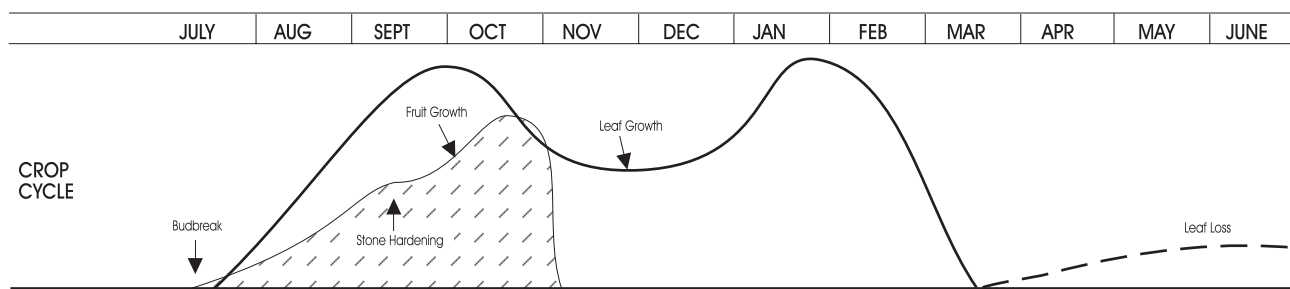
Once trees begin to bear, the management focus changes. The aim from the second year on is to manage the fruit bearing surface to produce quality fruit. The desired annual cycle for trees at this stage is shown in Figure 3. The cycle shown applies to a variety such as Flordaprince grown in coastal south-east Queensland. Cycles for other varieties and other locations may need calendar adjustment.



Nursery tree suppliers  
Section 6 page 5



Managing young trees  
Section 3 page 16



**Figure 3.** Desired annual cycle for bearing trees

Several key management operations are essential to keep trees within this desired cycle to produce quality fruit.

- **Keep the leaves on the tree in autumn until the end of April.** This reduces the risk of new buds being exposed to weather conditions (short periods of cool weather followed by warm weather) responsible for breaking their shallow dormancy and producing an early, out-of-season flowering. In general, these out-of-season flowerings are undesirable. The fruit may be of poor quality and the subsequent main crop is reduced. In frost-prone locations, early flowerings may also be damaged by frost.

Leaves fall early because of applied stress, a signal similar to the onset of colder weather that induces natural leaf fall. The key to keeping leaves on the tree is avoiding leaf stress. This means ensuring adequate irrigation water is applied, controlling leaf diseases such as rust and shot hole, and pests such as spider mites, and ensuring there is enough nitrogen fertiliser available from December onwards to keep the leaves fed. Don't overdo the nitrogen — excessive nitrogen may induce late growth flushes which delay flowering. Also avoid hard summer or autumn pruning, which induces leaf stress by making the remaining leaves work harder.

- **Manage the spring vegetative flush to prevent it getting too vigorous.** If the spring vegetative flush is too vigorous, it competes with the developing fruit for the available energy reserves. It also shades the inside of the tree, reducing the intensity of colour in the developing fruit, and reducing the development of strong fruiting wood for the next season. Over-vigorous flushes need stronger and more frequent spring pruning to prevent shading of the developing fruit and new fruiting wood.

Management of the spring vegetative flush involves careful management of nitrogen fertiliser in late winter and early spring, and the use of the growth retardant, Cultar, to reduce the potential size of the flush.

- **During late spring and summer, build good fruiting wood for the next season.** Good fruiting wood consists of strong laterals produced close to the main leaders of the tree during the spring and summer growth flushes. There are two important management

more info



Managing bearing trees  
Section 3 page 22



operations to achieve good fruiting wood. The first is judicious spring and summer pruning to allow light to penetrate inside the tree and stimulate growth. The second is careful management of water to avoid water stress during the spring and early summer growth phase. Once laterals are set, they need to be well protected against pests and diseases so that they can develop to their full potential.

- **Manage watering carefully during the critical stages of fruit growth.** The first critical stage of fruit growth is Phase 1, when cell division is taking place. Water stress during this phase reduces the number of cells produced, thereby limiting potential fruit size. The second critical stage is Phase 3, when the cells produced during Phase 1 are expanding. Water stress during this phase prevents the fruit reaching its potential size. If watering is uneven during Phase 3, fruit may split and the skin crack.

Water management at other times of the year may also profoundly affect fruit development. For example, severe water stress in late summer and early autumn may reduce fruit set to the extent that remaining fruit are more susceptible to the split stone condition. Production of twin fruit is also more prevalent. Water stress during flower initiation in December/January also results in the development of smaller flower buds. To prevent water stress, use soil moisture monitoring devices to carefully schedule irrigation to the needs of the tree. It is also important to control weeds within the root zone to remove competition for water and nutrients.

- **Thin fruit to achieve maximum fruit size.** The rapid fruit expansion during Phase 3 is fed from water, carbohydrates and minerals manufactured or stored in the tree. As there is a set and finite reserve of these materials, each fruit must compete for its small share. A smaller number of fruit, therefore, will be able to obtain more of the reserve and hence grow larger. If excess flowers and fruit are removed early, more of the finite reserve will be left for the remaining fruit. Early flower and fruit thinning is a vital operation in profitable low chill stonefruit. Where there is a danger of late frosts, fruit thinning is preferred to flower thinning.



## Economics of low chill stonefruit production

*New growers are attracted to low chill stonefruit by the perception of good returns from buoyant prices on the domestic market. The crop is also perceived to offer a quick return compared with other tree crops and good profitability from a small area of land.*

*A sensible appraisal of the prospects for low chill stonefruit, however, is only possible with a thorough economic analysis. This section provides some perspectives on the profitability of the crop.*

Background to the analyses .....	9
Economics — Atherton Tableland .....	10
Economics — Northern NSW .....	13

### **Background to the analyses**

Two different but related economic analyses for low chill stonefruit are summarised in this section. The first is a study in the Mareeba-Dimbulah irrigation area which analyses a model or hypothetical farm of four hectares of low chill peaches. It provides an annual whole orchard profit and loss statement at orchard maturity. This includes gross income, variable costs and fixed costs on a whole orchard basis. The variable or operating costs include the growing, harvesting and marketing costs. The fixed or overhead costs include an allowance for the farmer's own labour, administration costs, electricity, and depreciation. A gross margin, which is the difference between the gross income and the variable or operating costs, is calculated. The study also includes a discounted cash flow analysis to determine the annual cost of production and profitability. It is a technique used widely to analyse profitability for long term tree crops where costs and benefits occur over a long period. The technique reduces the time stream of costs and benefits to an equivalent amount of today's dollars. That amount is known as the present value of the future stream of costs and benefits. The present values are calculated using compound interest and a specified discount rate (in this case 6%). The Net Present Value (NPV) is the difference between the present value of the benefits and the present value of the costs.

The second analysis is a study from northern New South Wales which provides a simple cash flow budget on a hectare basis for a netted orchard grown under the palmette system. The cash flow budget analyses cash flowing in as receipts or income and cash flowing out as variable and capital costs. The cash flow is organised on an annual basis and extends over a ten year period.

## **Economics — Atherton Tableland**

---

Information courtesy of Andrew Hinton, Economist, DPI, Mareeba. Figures used in the analysis were current as at May 1994.

### **Assumptions**

Here are the main assumptions in this analysis:

- The hypothetical orchard consists of four hectares of irrigated low chill peaches.
- Trees are planted on a palmette system with 4 m between rows and 2.75 m between trees (909 trees/ha).
- The orchard is considered to be at steady state full production in the third year.
- The orchard is totally netted using a 20 mm square mesh net.
- Mature tree yields are considered to be 20 kg/tree with marketed fruit fetching an average price of \$4/kg or \$14 per single layer tray.
- Land cost is not included.
- Capital equipment is bought at the start of the operation and is purchased new, except for a tractor and utility which are bought second-hand.
- Machinery operation includes fuel and oil costs only.
- No permanent labour is used. Casual labour is employed for pruning, thinning, harvesting and packing to supplement family labour of the owners. All other activities are carried out by the owners and is not costed.
- The orchard is well managed.
- A project life of 10 years is used with a real discount rate of 6% to calculate the net present value (NPV).

### Variable costs at full production

Item	No./yr	Unit	Units/ha	\$/unit	\$/ha
<b>Machinery operation</b>					
Weed spraying	5	hour	1.5	8	60
Pest/disease spraying	20	hour	1	8	160
Slashing	6	hour	2	8	96
<b>Pruning and thinning</b>					
Pruning	2	hour	303	11	5 016*
Thinning	1	hour	455	11	4 725*
<b>Fertiliser</b>					
Muriate of potash	1	kg	545	0.42	229
Superphosphate	1	kg	107	0.37	40
Urea	1	kg	204	0.42	86
<b>Weed control and mulching</b>					
Glyphosate	2	L	3.63	10.26	75
Paraquat	3	L	4.1	7.59	93
Mulch	1	bale	55	7	385
Mulching labour	1	hour	40	11	440
Irrigation	–	ML	19.61	45	883
<b>Pest/disease control</b>					
Mancozeb	12	kg	4.55	6.82	372
Copper oxychloride	1	kg	17.05	3.51	60
Fenthion	6	L	1.70	48.75	497
Dicofol	2	L	2.84	36	204
Cultar	1	L	3	196	588
<b>Harvesting and marketing</b>					
Labour (picking and packing)	1	tray	5 194	1.32	6 856
Packaging	1	tray	5 194	1.62	8 415
Freight	1	tray	5 194	1.04	5 402
Levies	1	tray	5 194	0.14	728
Agent's commission (12%)	1	tray	5 194	1.68	8 726
Pallet strapping and corners	1	tray	5 194	0.05	275
<b>TOTAL VARIABLE COSTS</b>					<b>44 411</b>

\* owner contributes 300 hours to pruning and 100 hours to thinning

### Fixed costs for the 4 ha orchard

Item	Amount (\$/year)
Allowance for family labour	25 000
Fuel and oil for utility and farm motorbike	1 800
Electricity for equipment, lighting and cold room	1 000
Repairs and maintenance	8 000
Administration	6 000
Depreciation	26 202
<b>TOTAL FIXED COSTS</b>	<b>68 002</b>

### Capital costs for the 4 ha orchard

Item	Year/s of purchase	Cost (\$)
Tractor (45 kw)*	0	15 000
Utility*	0,5	10 000
4-wheel-motorbike	1,5	7 000
Slasher	0	5 000
Mulch spreader	0	9 000
Main sprayer	0	6 000
Knapsack sprayer	0	1 000
Electricity installation	0	5 000
Irrigation equipment	0	26 000
Cold room	2	20 000
Benches	0	500
Picking equipment	0,3,6,9	500
Shed	0	10 000
Workshop equipment	0,5	1 000
Roads	0	500
Land (opportunity cost only)	0	6 000
Land preparation	0	1 540
Planting	0	54 055
Netting	2	40 000
<b>TOTAL CAPITAL COSTS</b>		<b>218 095</b>

\* - purchased second-hand

### Profit and loss statement for the 4 ha orchard (NPV)

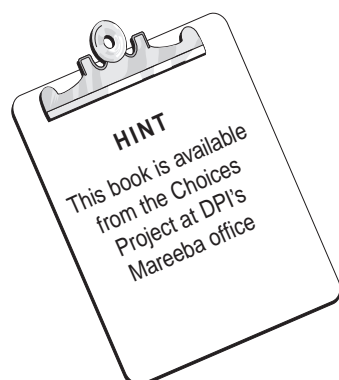
Item	\$/farm/yr	\$/kg
<b>GROSS INCOME</b>	<b>234 250</b>	<b>4.00</b>
<b>Variable costs</b>		
Machinery operation	1 264	0.02
Pruning and thinning	36 999	0.63
Fertiliser and mulch	5 167	0.09
Insect/disease control	4 187	0.07
Irrigation	3 086	0.05
Weed control	671	0.01
Cultar	2 452	0.04
Harvesting and marketing	97 934	1.67
<b>TOTAL VARIABLE COSTS</b>	<b>151 761</b>	<b>2.59</b>
<b>Fixed costs</b>		
Allowance — family labour	26 698	0.46
Administration	6 000	0.10
Repairs and maintenance	8 000	0.14
Fuel and oil	1 800	0.03
Electricity	1 000	0.02
Depreciation	26 202	0.45
<b>TOTAL FIXED COSTS</b>	<b>69 701</b>	<b>1.19</b>
<b>TOTAL COSTS</b>	<b>221 461</b>	<b>3.78</b>
<b>Return to management</b>	<b>12 789</b>	<b>0.22</b>
<b>GROSS MARGIN</b>	<b>82 489</b>	
<b>GROSS MARGIN/hectare</b>	<b>20 622</b>	
<b>GROSS MARGIN/tray</b>		<b>3.97</b>

## Discounted cash flow analysis for the 4 ha orchard

Year	Yield (kg/year)	Receipts	Operating costs	Fixed costs	Capital costs	Discounted annual cash flow	Discounted accumulated cash flow
0	0	0	0	12 500	158 095	-170 595	-170 595
1	0	0	26 671	41 800	0	-64 596	-235 191
2	32 724	130 896	98 149	41 800	60 000	-61 458	-296 649
3	72 720	290 880	187 662	41 800	450	51 190	-245 458
4	72 720	290 880	188 389	41 800	0	48 073	-197 385
5	72 720	290 880	179 120	41 800	11 800	43 460	-153 925
6	72 720	290 880	179 120	41 800	450	49 002	-104 923
7	72 720	290 880	179 120	41 800	0	46 527	-58 396
8	72 720	290 880	179 120	41 800	0	43 894	-14 503
9	72 720	290 880	179 120	41 800	450	41 143	26 640
10	72 720	290 880	179 120	41 800	-50 900	67 487	94 128
<b>Total (PV)</b>	<b>431 025</b>	<b>1 724 102</b>	<b>1 116 969</b>	<b>320 152</b>	<b>192 852</b>		

The analysis shows that the peak overdraft, \$296 649, occurs in the second year and annual expenses exceed annual income until the third year. The payback period, or the time required for accumulated income to exceed accumulated expenses, is nine years. Put another way, it would take nine years to recover the initial project outlay.

**Reference for further reading and research:** *Growing low chill peaches in the Mareeba–Dimbulah Irrigation Area — an economic perspective* by Andrew Hinton, in *Stonefruit — Choices Seminar Series No 4* (1994), Department of Primary Industries, Mareeba.



## Economics — Northern NSW

Information courtesy of John Slack, District Horticulturist, NSW Agriculture, Alstonville.

Figures used in the analysis were current as at October 1992.

### Assumptions

Here are the main assumptions in this analysis:

- Trees are planted on a palmette system with 4 m between rows and 2.5 m between trees (1000 trees/ha).
- The orchard is considered to be at steady state full production in the seventh year.
- The orchard is totally netted using a 20 mm square mesh net.
- Mature tree yields are considered to be 18 kg/tree with marketed fruit fetching an average price of \$3/kg or \$9 per 3 kg single layer tray. Price is net of agent's commission and levies.
- Land and overhead costs are not included.
- Capital equipment is bought at the start of the operation and is purchased new with costs spread over 2.5 ha.

- Machinery operation includes fuel and oil costs only.
- No permanent labour is used. Casual labour is employed for tree planting, pruning, thinning, harvesting and packing to supplement family labour of the owners. All other activities are carried out by the owners and is not costed.
- The orchard is well managed.

### Variable costs at full production

Item	No/ year	Unit	Units/ha	\$/unit	\$/ha
<b>Machinery operation</b>					
Pest/disease spraying	25	hour	1.5	12	450
Slashing	10	hour	1.5	12	180
Harvesting	3	hour	5	12	180
<b>Pruning and thinning</b>					
Pruning	1	hour	166	10.50	1 750
Thinning	1	hour	333	10.50	3 500
<b>Fertiliser</b>					
Muriate of potash	1	kg	140	0.42	59
Superphosphate	1	kg	100	0.27	27
Urea	3	kg	50	0.42	63
Lime	1	kg	600	0.06	36
<b>Weed control</b>					
Glyphosate	1	L	6	11.25	68
Paraquat	6	L	2.1	8.27	104
<b>Irrigation</b>	–	ML	6.46	45	291
<b>Pest/disease control</b>					
Mancozeb	8	kg	3	5.31	127
Copper oxychloride	5	kg	7.5	2.97	111
Fenthion	8	L	1.1	44.60	401
Benomyl	2	kg	0.8	53.15	80
Chlorpyrifos	2	L	1.5	21.46	64
Chlorothalonil	5	kg	3.5	15.53	268
Endosulfan	2	L	2.9	8.23	47
Iprodione	1	kg	0.8	56.60	42
Lime sulphur	1	kg	75	1.87	140
Propargite	1	kg	5.5	24	132
Summer oil	1	L	45	1.26	57
<b>Harvesting and marketing</b>					
Labour (picking and packing)	1	tray	4 167	1.31	5 459
Packaging	1	tray	4 167	1.13	4 709
Freight	1	tray	4 167	0.70	2 917
<b>TOTAL VARIABLE COSTS</b>					<b>21 262</b>

### Capital costs

Item	Year/s of purchase	Cost (\$)
Tractor	1	20 000
Slasher	1	1 500
Main sprayer	1	5 500
Herbicide sprayer	1	500
Fruit grader	3	12 000
Irrigation equipment	1	6 000/ha
Cold room	2	10 000
Machinery and chemical shed	1	5 000
Packing shed	1	10 000
Orchard establishment	1	8 306/ha
Netting	2	21 000/ha
<b>TOTAL CAPITAL COSTS PER HECTARE</b>	<b>52 306</b>	

### Cash flow budget for one hectare

Year	Yield (kg/tree)	Yield (trays/ha)	Receipts (at \$9/tray)	Capital outlays	Variable costs*	Total cash outlays	Cash surplus or deficit	Accumulated cash surplus or deficit
1	0	0	0	52 306	3 400	55 705	-55 705	-55 705
2	3	1 000	9 000	4 000	9 652	13 652	-4 652	-60 357
3	6	2 000	18 000	4 800	16 813	21 613	-3 613	-63 969
4	9	3 000	27 000	0	19 955	19 955	7 045	-56 925
5	12	4 000	36 000	0	23 098	23 098	12 902	-44 022
6	15	5 000	45 000	0	26 240	26 240	18 760	-25 263
7	18	6 000	54 000	0	29 383	29 383	24 617	-645
8	18	6 000	54 000	0	29 383	29 383	24 617	23 972
9	18	6 000	54 000	0	29 383	29 383	24 617	48 589
10	18	6 000	54 000	0	29 383	29 383	24 617	73 206

\* includes an allowance for administration

The analysis shows that the peak overdraft, \$63 969, occurs in the third year and annual expenses exceed annual income until the fourth year. It takes eight years for accumulated cash receipts to exceed accumulated cash outlays.

### Net returns per hectare at varying prices and yields

Yield (trays/ha)	Price (\$/tray)				
	4	6	8	10	12
500	-10 099	-9 099	-8 099	-7 099	-6 099
1000	-9 670	-7 670	-5 670	-3 670	-1 670
1500	-9 241	-6 241	-3 241	-241	2 759
2000	-8 813	-4 813	-813	3 187	7 187
3000	-7 955	-1 955	4 045	10 045	16 045
4000	-7 098	902	8 902	16 902	24 902
5000	-6 240	3 760	13 760	23 760	33 760
6000	-5 383	6 617	18 617	30 617	42 617

**Reference for further reading and research:** *Low chill stonefruit — costs and returns* by John Slack (1992), NSW Agriculture, Alstonville.





## Planning the orchard layout

*Planning the orchard layout is often done hastily and without regard for the long term consequences. Yet it is probably one of the most important steps in ensuring long term profitability and stability of the low chill stonefruit orchard. This is because of the impact of orchard layout on land degradation and its subsequent effects on tree health, soil fertility and ease of access. It is all the more important because mistakes made at the orchard establishment stage are difficult and costly, if not impossible, to correct.*

*Orchard planning can be a complex procedure and we recommend you get some expert assistance. In Queensland, this is available from land conservation extension officers of the Department of Natural Resources. In New South Wales, assistance is available from NSW Agriculture (orchard planning) and the Department of Land and Water Conservation (design for erosion control).*

*Here are the important things you need to know:*

Understanding land degradation .....	16
The elements of good orchard planning.....	18
The bigger picture .....	24

### **Understanding land degradation**

Land degradation is a term which is used to describe a permanent decline in productivity of land. Some forms of land degradation include soil erosion, soil structural decline, reduced fertility and increasing acidity.

The two most visible types of land degradation associated with horticulture in Queensland and New South Wales are gully erosion and mass movement including landslip.

These can occur individually or in combination with other less visible types and seriously threaten the long term viability of orchards. Although these types of land degradation are most visible, they are not necessarily the most significant forms. Remember that by the time you see a gully, serious soil erosion and other problems already exist in the surrounding areas.

### **Gully erosion**

Soil erosion begins on bare or cultivated ground when raindrops seal the surface and dislodge soil particles which gradually move downhill. Any water flowing over the surface will carry this loose soil material

with it, forming rills and eventually gullies. Where the soil surface is bare and the topography steep, soil erosion losses can be dramatic. In extreme cases, more than 300 tonnes of soil can be lost from each hectare each year.

Sloping land should be treated with soil conservation structures such as diversion drains, v-drains and grassed interrow strips to control soil loss before it becomes a problem. Water needs to be diverted away from crop areas at regular intervals to reduce the concentration and erosive potential of runoff.

### **Mass movement including landslip**

Landslips usually develop when an impervious layer of either rock or clay is present beneath the surface. When the soil is saturated and subsurface water is flowing on top of the impervious layer, the ground can become mobile and move downhill. These movements are often sudden and can extend over several hectares, though most are localised, covering only a few square metres.

Steep slopes, high rainfall and a lack of deep rooted vegetation greatly increase the risk of landslips.

Where landslips occur a range of rehabilitation measures can be used to make the slip and adjacent areas safe and stable. These include:

- locating diversion banks or drains above the slip area where possible, to intercept and divert runoff water away from the slip and into more stable areas;
- re-shaping, when water ponding occurs at the back of the slip, to remove water from this vulnerable area;
- using agricultural drainage pipes to intercept and remove subsurface water flows;
- maintaining a good grass cover and using trees wherever possible to stabilise and 'dry out' the slip area.

### **Off-site effects of land degradation**

The off-site or downstream effects of land degradation are costs borne by the landholder at the erosion source and by the community. Transported soil material contains fertilisers and chemicals which can have serious environmental consequences some distance from the soil erosion source. Land degradation caused by erosion within any catchment can lead to:

- sedimentation of culverts, drainage lines and watercourses which increases flooding risks and drainage costs;
- deterioration of water quality;
- reduced water storage capacity of dams;
- pollution of dams, creeks and rivers by soil, agricultural chemicals and fertilisers.

## **The elements of good orchard planning**

---

### **The best site**

Careful site selection plays a big part in reducing the potential for land degradation. There are five important points to consider.

### **Soil type**

Soil type has a major effect on the amount of soil loss. Sandy surface soils, for example, are generally more prone to erosion than clay soils. Of equal importance is the physical condition of the topsoil — called soil tilth. Soil which has been cultivated to a fine tilth when preparing planting sites is more susceptible to erosion damage than an undisturbed soil. Soils least likely to erode are those that are cultivated as little as possible and protected by a mulch or standing cover crop.

The best soils for low chill stonefruit are free-draining soils with no heavy clay or rock within at least one metre of the surface.

Problem soils are:

- heavy clays because they restrict root development and favour root diseases;
- rocky soils because they damage implements and machinery;
- light sandy soils because they have low water-holding capacity and poor retention of nutrients;
- poorly drained and shallow soils because they restrict crop growth and may cause tree death;
- soils with unstable subsoil because they restrict root penetration.

### **Aspect**

Slopes facing north, north-east and north-west are preferred, particularly in central and southern Queensland and northern NSW. These sites are generally warmer and better protected from the damaging winds from the south-east in summer and the west in winter.

### **Slope**

Always select the flattest areas available. All sloping land will require some erosion control measures.

Slopes of less than 15% are preferred for safe machinery operation and to allow a wider range of options for farm layout and soil erosion control. They also enable the easier provision of all-weather access to the crop, which is vital for harvesting and pest and disease control.

Slopes of more than 15% make it difficult to operate machinery safely and carry a high risk of erosion damage. Remember that erosion removes valuable topsoil and nutrients, reducing tree vigour and productivity. Steep slopes can also lead to erosion of access tracks, resulting in postharvest fruit damage during transport. Steep slopes require more substantial and costly erosion control measures.

### **Wind protection**

Protection from damaging south-easterly and westerly winds is essential. Wind can severely damage trees through limb breakage as well as reducing yields and fruit quality. It also increases evaporation, thereby making irrigation less efficient, and may cause wind erosion. Unprotected orchards have less flexibility in spray application and sprays are more subject to drift. Wind protection can be offered by natural stands of timber but planting of windbreaks is recommended on all orchards.

### **Access to irrigation water**

Check that you have access to enough good quality irrigation water. As a rule of thumb, two years supply is regarded as the minimum level for maintaining a crop throughout periods of drought.

### **A planning map**

Prepare a map of the farm on which you can develop a plan for windbreaks, on-farm access, erosion control structures, water harvesting and storage, and the irrigation system. To avoid costly mistakes, seek professional advice.



---

Farm planning  
assistance  
Section 6 page 11–12

---

### **Good windbreaks**

There are four options for windbreaks:

- Retain existing natural stands of timber.
- Plant tall, quick growing grasses such as bana grass. When planted in spring, it will form a dense windbreak by the next winter. Annual maintenance by deep ripping close to the bana grass to sever roots will prevent it spreading into the root zone of the orchard trees.
- Plant dense, quick growing trees and shrubs. Two or more rows of trees and shrubs provide the best protection.
- Erect artificial windbreaks. These are commonly constructed of mesh materials such as shade cloth. They are expensive but require less room than planted windbreaks.

Retaining natural timber and planting trees and shrubs to supplement the natural timber are the recommended options. Before clearing, seek professional advice on the way you go about your clearing. Leave windbreaks on all sides of the intended orchard site where possible. Leave timber on all major drainage lines as these can be used to safely dispose of runoff water from the crop. If planting windbreak trees, make sure they are at least 10 m from the low chill stonefruit trees to allow machinery access and to reduce shading and root competition.

### **All-weather, on-farm access**

All-weather access is vital for the efficient management of an orchard. This provides unhindered machinery movement for harvesting, spraying and other field operations. Major roadways can be easily main-



tained if water from adjoining fields is shed away from the roadway (Figure 4). Roadways should be constructed wide enough to allow for movement of spray equipment and other machinery without damaging the trees.

Here are the important points to remember:

- Locate access tracks on ridgelines wherever possible.
- Plant the trees parallel to access tracks on ridgelines where slope permits.
- Always shed runoff away from access tracks.
- Use contour drains to move this water to stable watercourses/gullies.
- Concrete pipes will often be needed when crossing major drainage lines. Concrete or rock inverts are ideal for dam spillways and other regular crossing points.
- Ensure access tracks are constructed and maintained at least four metres wide.
- Most access tracks require 'whoa boys' or speed bumps to catch and divert water safely off the track. In most situations, speed bumps should be no more than 50 m apart. They are best located where slope changes or suitable outlet points are found.

### Erosion control measures

Uncontrolled water runoff causes the loss of valuable topsoil and exposes the surface roots to desiccation. It may also pool within the orchard, causing waterlogging and root rot. Surface drainage structures such as contour drains and v-drains are required to safely dispose of runoff into stable waterways. These structures are designed to shorten slope lengths to reduce the impact of erosion and to prevent ponding around the roots. It is essential that these structures are correctly designed, constructed and maintained. Failure of structures will result in increased levels of soil erosion. For this reason, seek expert assistance in designing them.

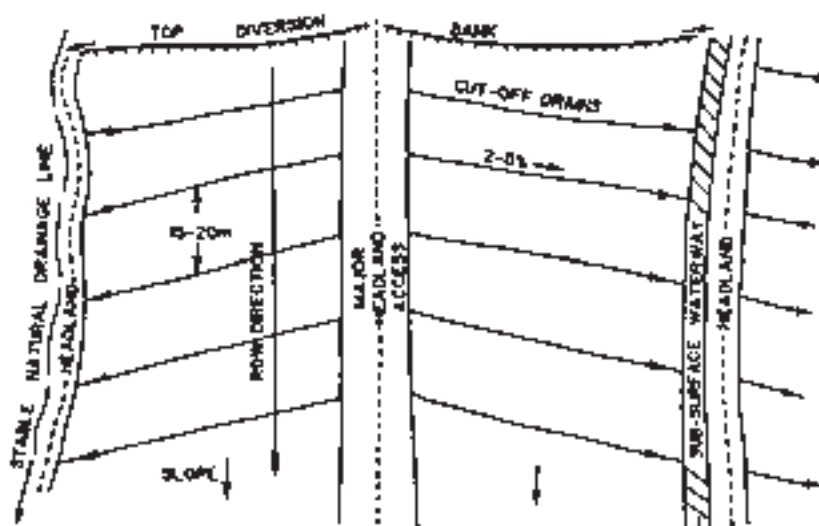
Here is an overall view of what's required.

- On slopes of less than 4%, rows can be run across the slope or up and down the slope without any soil erosion structures within the orchard.
- On slopes of 4 to 15%, rows can be run across the slope or up and down the slope but contour drains or v-drains are required within the orchard to control runoff. If rows are run across the slope, locate drains and rows as close as possible to the contour with a fall of 2 to 5% to safely remove water (Figure 4). If rows are run up and down the slope, contour drains are required at least every 50 m down the slope. A slope of 15% is the safe maximum limit for working a two-wheel-drive tractor across the slope.



Design assistance  
Section 6 page 11–12

- Try to avoid slopes greater than 15%, but if they are planted, run rows up and down the slope for safe machinery use. Cut-off drains will be required at regular intervals down the slope to intercept runoff water (Figure 4).



**Figure 4.** General layout for crops on steeper slopes

- The orchard needs to be protected from water flowing from land directly above it by building a diversion or contour drain at the top of the site (Figure 4).
- On flatter ground, row direction should suit the design needs of the irrigation system. Consult a qualified irrigation designer for assistance.
- Try to get long rows as these are preferred for machinery efficiency, but remember you need breaks in the rows to facilitate efficient harvesting.
- Don't use depressions or low points in the paddock as these carry runoff during storms. Maintain or replant these areas with a low growing, vigorous grass such as carpet grass, couch, African star grass or kikuyu. The grass must be regularly slashed to assist the rapid removal of runoff from the orchard.

### **Diversion drain**

A diversion or contour drain is required to protect sloping orchard land from water flowing from above. This flow will greatly increase potential crop damage and complicate water disposal problems as it concentrates further down the slope. The drain should be at a gradient of 1 to 5% and large enough to handle the water from the catchment above. It should empty into a grassed waterway or a stable natural watercourse. Keep the steeper sections furthest from the waterway or watercourse. Table 2 contains information on maximum gradients for drains of different lengths on a range of different soil types.

**Table 2.** Diversion drains: maximum gradients and lengths for different soil types

Diversion drain length (m)	Maximum gradients		
	Gravelly soils	Sandy soils	Red clay soils
50	3%	3%	5%
75	3%	2%	4%
100	2%	2%	3%
150	1-2%	1%	2%

To avoid overtopping or failure of diversion drains, they should be located using a levelling device, for example, a dumpy level, hand level, or water tube level. To prevent scouring of the drain channel, establish a creeping or sward-type grass such as carpet grass, couch, African star grass or kikuyu in the channel.

Contour drains within the orchard are built to similar specifications as diversion drains.

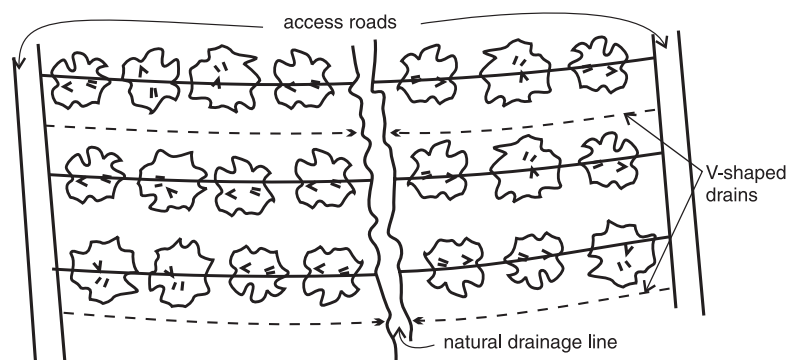
### Waterways

Diversion drains and all other runoff control structures should empty into stable grassed waterways — either natural depressions or constructed waterways. Constructed waterway channels are built below the ground surface level to allow rows and drains to discharge into the channel. They need a flat bottomed channel stabilised with carpet grass, couch, African star grass or kikuyu, to safely carry runoff water down the slope.

### V-drains

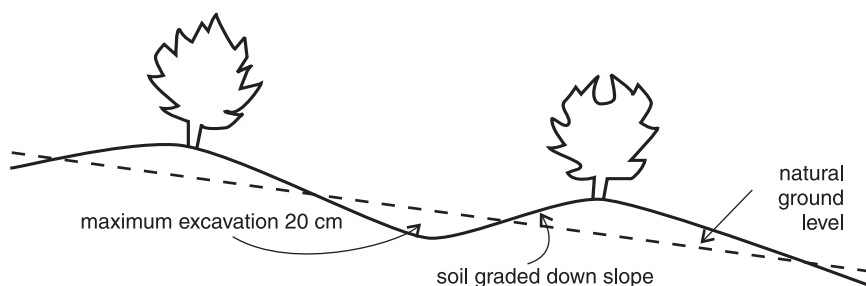
Within the orchard, shallow, wide v-shaped drains are constructed in the centre of the interrow to provide drainage and to control water flow. Maximum excavation depth is 20 cm. They are usually built by a grader or tractor-mounted blade.

For rows across the slope, v-shaped drains are constructed every second or third row and angled across the slope at a 2% gradient (Figure 5). The maximum distance between the v-drains should be 15 m.



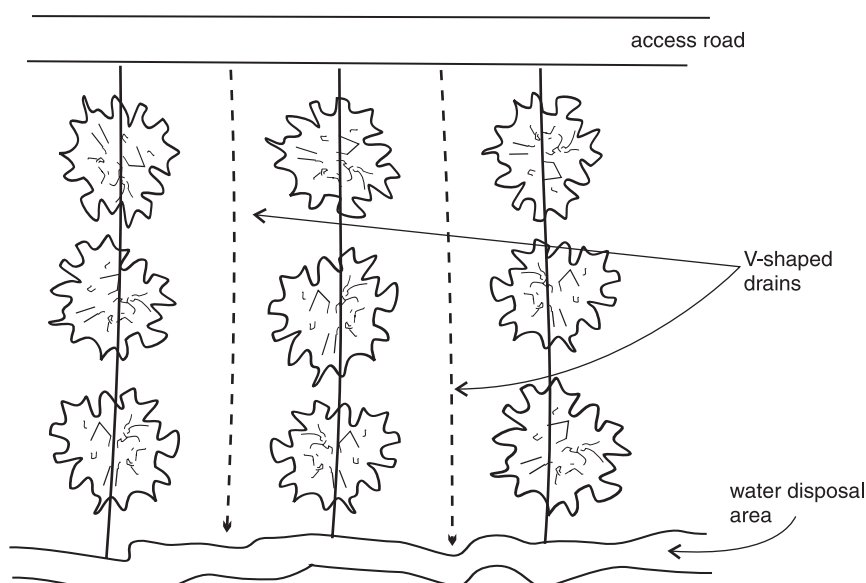
**Figure 5.** Across slope rows with v-drains (plan view)

Soil from the drain is moved on to the proposed downhill tree line (Figure 6).



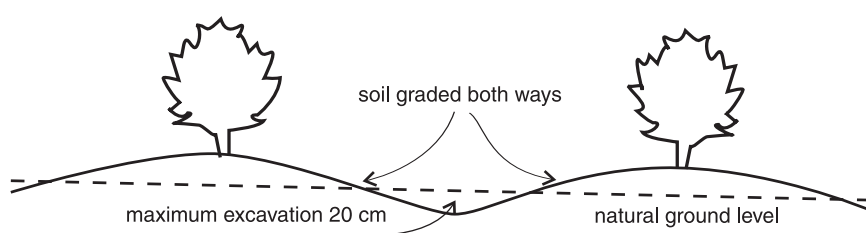
**Figure 6.** Across-slope rows with v-drains (cross-section view)

For rows up and down the slope, v-shaped drains are constructed between every interrow area to control side slope runoff (Figure 7).



**Figure 7.** Down-slope rows with v-drains (plan view)

Soil from the drain is moved both ways on to the proposed tree lines (Figure 8).



**Figure 8.** Down-slope rows with v-drains (cross-section view)

**Bench terracing**

The construction of a series of bench terraces across the slope is suitable for specific locations. Bench terracing involves major earthworks which are expensive to construct, reshape or remove, so they are recommended for use only in special circumstances and then only with expert assistance in their design and construction. A deep (stable) non-dispersible soil is essential for success with bench terraces.

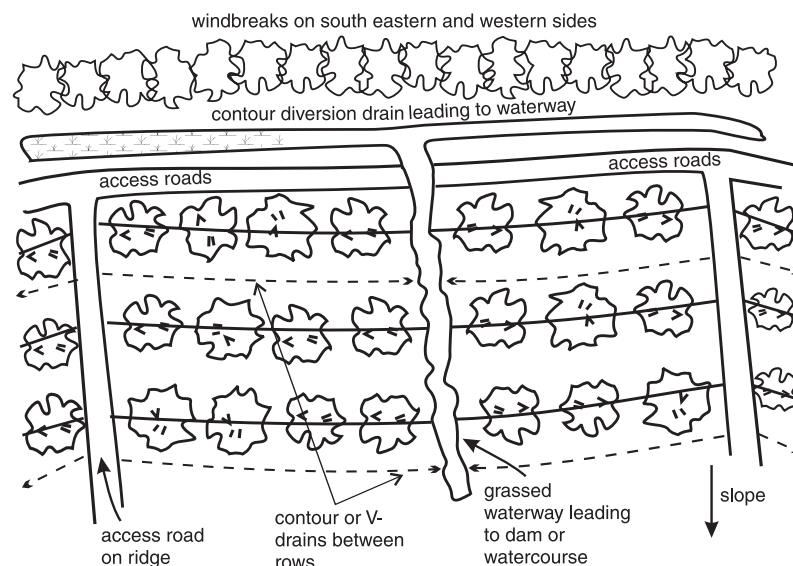


## Water harvesting and storage

A good orchard layout should incorporate water harvesting. This means that runoff is removed from the orchard site and directed into a dam for later irrigation use.

The type of irrigation system used should be integrated in the orchard layout to be compatible with erosion control structures, access roads and drainage. Locate irrigation mains and hydrants close to access tracks. Under-tree minisprinklers are preferred because of their lower water consumption and better water distribution. When planning irrigation, seek specialist advice from a qualified irrigation designer.

An example of an orchard design plan incorporating some of these features is shown in Figure 9.



**Figure 9.** An example of an orchard design plan

## The bigger picture

Following these planning principles for orchard layout will benefit your farm as well as your whole catchment and community.

Joint Government and community initiatives encourage people to cooperate and work together on a catchment basis to reduce the offsite effects of land degradation. Adoption of the recommended planning principles will lead to a reduction in the impact of community problems such as:

- poor water quality due to nutrients contained in runoff water;
- siltation of rivers, streams and harbours;
- algal blooms in water storage;
- loss of production caused by soil erosion.

For further information on how you can be more involved at a community level, contact Landcare and Catchment Management Groups in your area.



## Determining chilling units

To select appropriate low chill stonefruit varieties for your orchard, you need to determine the amount of chilling received. Here is what you need to know about chilling and its measurement:

Understanding chilling and its effects .....	25
What are chilling temperatures? .....	26
Models for calculating chilling .....	26
Chilling ready reckoner for low chill stonefruit .....	28

### Understanding chilling and its effects

Stonefruit trees initiate new leaf and flower buds in summer (low chill varieties) or autumn (high chill varieties). As the shorter daylengths and cooler temperatures of winter approach, these buds go into a state of dormancy. This dormancy or sleeping stage is designed to protect the buds from the cold winter weather. While the buds are dormant, they are tolerant of temperatures below freezing point. The buds remain dormant until warm weather stimulates a release from dormancy, and they then begin to grow.

To be most productive, dormant buds have to be exposed to sufficient cold weather to satisfy what is known as the chilling requirement. The chilling requirement varies from variety to variety according to its genetic make-up.

If there is sufficient chilling, the leaf and flower buds develop normally and grow away vigorously. If there is insufficient chilling, dormancy is not completely broken and buds behave abnormally. The common effects of this are:

- delayed or poor leaf development
- reduced fruit set and buttoning
- reduced fruit quality.

### Delayed or poor leaf development

The classic symptom of delayed or poor leaf development is small tufts of leaves (rosettes) near the tips of branches and few or no leaves for 30 to 45 cm back towards the trunk. Lower buds will eventually shoot but often not until later in spring or in early summer.

The late development of leaves delays their contribution to food manufacture for the tree and the developing fruit, resulting in reduced

yield. In addition, trees frequently sucker from the trunk or in the branch angles of the main leaders.

### **Reduced fruit set and buttoning**

Flowering often follows the pattern outlined previously for leaf development. Bloom is delayed, extended, and because of abnormalities in ovary and pollen development, fruit set is reduced.

In some peach varieties, flowers drop, and in others, buttons form. Buttons result from flowers that apparently have set, but never develop into full size fruit. The fruit remains small and misshapen as it ripens. If these fruit are cut open, the seed is dead.

Buttoned fruit cannot be distinguished at thinning. They remain an unproductive nuisance and are potential sites for pest and disease infestation.

### **Reduced fruit quality**

The effects of insufficient chilling on fruit quality are probably the least discussed, but probably the most common and important. Where delayed leaf development and reduced fruit set can be dramatic, the effects on fruit quality are subtle.

These include enlarged tips, greener background colouring, reduced firmness (especially in the tip) and more prominent sutures. The result is a significant reduction in fruit quality.

## **What are chilling temperatures?**

---

There is still considerable debate about chilling temperatures for low chill stonefruit, mainly because most of the early research on chilling was conducted on high chill stonefruit varieties. However, it is generally agreed that temperatures below freezing or above 15°C are not effective for calculating chilling unit accumulation. Effective chilling is considered to range between 0° and 15°C. There are several models for calculating chilling, most developed on high chill varieties. These are of interest in providing background to the development of a model for low chill stonefruit.

## **Models for calculating chilling**

---

### **High chill models**

The three most common models have been:

- hours below 7.2 °C model
- hours between 0°C and 7.2°C model
- the Utah model.

The first two models are simple and define a chilling unit as one hour

below or between certain temperatures. The Utah model is more complex because it introduces the idea of relative chilling effectiveness and negative chilling accumulation (Table 3).

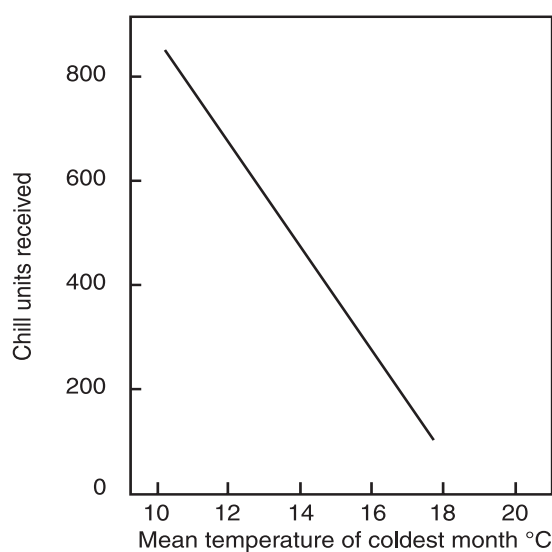
**Table 3.** *Utah model*

Temperature condition	Equals chill units
1 hour below 1°C	0.0 chill units
1 hour at 1.7 to 2.2°C	0.5 chill units
1 hour at 2.8 to 8.9°C	1.0 chill units
1 hour at 9.5 to 12.2°C	0.5 chill units
1 hour at 12.8 to 15.6°C	0.0 chill units
1 hour at 16.1 to 18.3°C	-0.5 chill units
1 hour at greater than 18.3°C	-1.0 chill units

All these models require hourly temperatures to be calculated which can be a laborious process. In addition, since these models were developed with high chill stonefruit, their usefulness for low chilling conditions has been questionable.

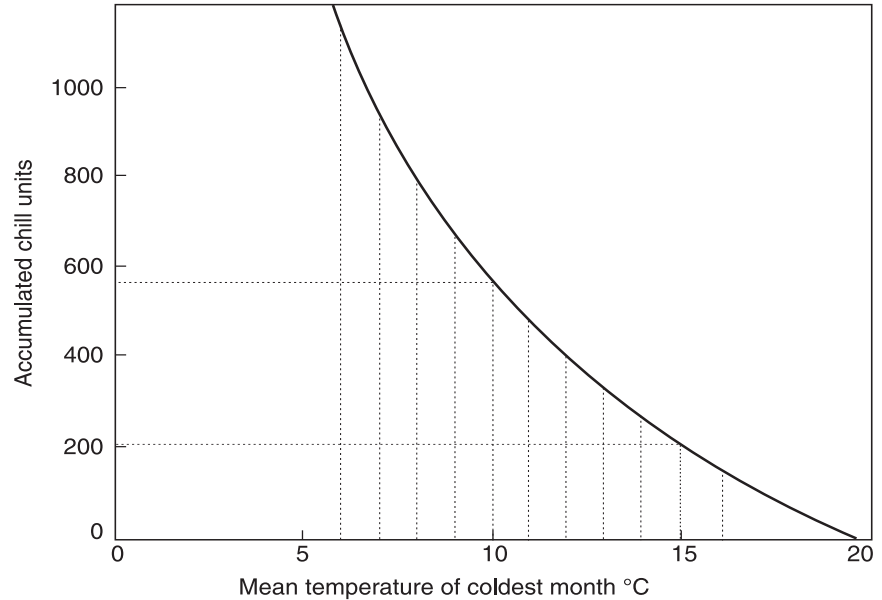
### A model for low chill stonefruit

In the 1980s, researchers in Georgia and Florida independently developed relationships between the monthly temperature of their coldest month/s and chilling units accumulated. Various adaptations of these have since evolved, the most relevant being the mean temperature model. For medium and low chill areas, it uses the mean temperature of the coldest month (January in the northern hemisphere and July in the southern hemisphere) to calculate chilling. In the high chill areas, a mean of the two coldest months (December–January in the northern hemisphere and June–July in the southern hemisphere) is used. Once this mean temperature is available, chilling units received can be simply calculated from a linear graph (Figure 10).



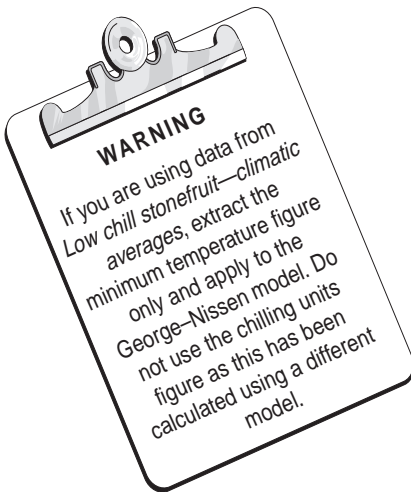
**Figure 10.** *Mean temperature model for low chill stonefruit*

Alan George and Bob Nissen from the Department of Primary Industries' Maroochy Research Station in Queensland have further refined this model for Australian conditions. Their mean temperature/chilling units relationship is shown in Figure 11. We recommend you use this model.



**Figure 11.** George–Nissen model for calculation of chill units in Australia

This model has proved to be accurate and is also simple to use. Records of mean temperatures are kept for many districts by the Bureau of Meteorology. The George–Nissen model has been made easier to use by John Slack, who has assembled temperature data for most low chill areas into a booklet *Low chill stonefruit — climatic averages*. For those without access to these records, a chilling ready reckoner is provided below.



### Chilling ready reckoner for low chill stonefruit

Step 1	Contact the Bureau of Meteorology and for your nearest weather station, obtain the mean temperature for July. If a mean monthly temperature is not available, obtain the mean maximum temperature and the mean minimum temperature for July, add them together and divide by 2.	Example for Nambour: Mean temperature for July = 13.8 °C
Step 2	Go to Figure 11 and locate the point on the bottom line corresponding to your mean temperature for July. From this point, go vertically upwards to the curve and then horizontally left to the chill units line.	
Step 3	On the vertical line, read off the chill units received.	Answer: 240 chill units

Adapted from an article by David H. Byrne, Terry A. Bacon and John Lipe from *The Texas Horticulturist*, January 1992.



## Selecting varieties

Success in commercial low chill stonefruit production largely depends on the correct selection of varieties. This is not always easy as there are many varieties to choose from and many differing opinions on which varieties are best. This section will help you make an informed decision about selecting varieties.

The basis for selecting varieties .....	29
Characteristics of the main varieties .....	31
New varieties for trial .....	32

### The basis for selecting varieties

Selecting varieties involves consideration of several factors. The broad process we suggest you follow consists of four steps.

#### Step 1. Determine how much chilling your orchard receives and compare this with the chill units required for each variety.

To determine the amount of chilling your orchard receives, follow the procedure outlined in *Determining chilling units*. The chill units we have assigned to the main varieties are listed in Table 4. In some cases, these differ to the rated chill units assigned by the breeder. This is because experience under Australian conditions has shown these varieties to perform well in lower chilling ranges.

**Table 4.** Assigned chill units for the main varieties

	Chill units		
	50 – 150	150 – 300	300 – 450
Peaches	Flordaprince (150)	Flordagem (250)	Flordagold (325)
	TropicBeauty (150)	Fla. 3-2 (200)	Forestgold (350)
	Newbelle (150)	Flordastar (225)	
	Flordaglo (150 – rated 200)		
Nectarines	SunWright (150)	Sunblaze (250)	Sunripe (400)
	Sunraycer (150 – rated 250)	Fla. 82-17N (275)	
Plums	Fla. 8-1 (150 – rated 200)		
	Gulfruby (150 – rated 350)		

Choose only varieties that fall within your determined chilling range. Use of varieties outside of this range may result in poor growth, reduced fruit set and poor fruit quality.

more info



Determining chilling units  
This section page 25

## Step 2. With the varieties chosen from Step 1, select those that are likely to meet the best market window.

The earlier the maturity, the better the price. The general rule of thumb is — warm temperatures during fruit development = earlier maturity = higher prices. However, all fruit marketed on the domestic market before about the third week of November will generally fetch reasonable prices as long as fruit is average or better in quality. The general maturity times for each variety are listed in Table 5.

**Table 5.** General maturity times for the main varieties

	Maturity times*		
	Early season (early to late October)	Mid season (late October to mid November)	Late season (mid November to mid December)
Peaches	Flordaprince	Flordagem	Newbelle
	TropicBeauty	Fla. 3–2	Forestgold
	Flordastar	Flordagold	
	Flordaglo		
Nectarines	SunWright	Sunblaze	Sunripe
	Sunraycer	Fla. 82–17N	
Plums		Fla. 8–1	
		Gulfruby	

\* maturity times for coastal Queensland, northern New South Wales, Atherton Tableland. Maturity times for inland Queensland are about two weeks later.

## Step 3. Assess which of the varieties chosen from Steps 1 and 2 has the best market acceptability.

Consumers are looking for fruit with good colour, good size, good shelf life, freedom from blemish and good flavour. The more of these characteristics a variety has, the higher is its market acceptability. Yellow fleshed varieties are preferred as there is a perception that these have better shelf life. Niche markets exist for white fleshed peaches but these require more marketing effort.

**Note that we are talking about market acceptability, not market performance.** For example, Flordaprince peach performs very well on the market because of its earliness. However, it has low market acceptability because of russet in cooler areas and heavy fuzz in warmer areas. Our rating of market acceptability is shown in Table 6. Note that Flordagold is used as the benchmark with a rating of 10. This does not suggest it is without faults and its rating is purely to provide a level against which the other varieties can be easily compared.

**Table 6.** Broad ratings for market acceptability

	Variety	Market acceptability rating (scale of 0–10): 0 = poor 10 = very good
Peaches	Flordagold	10
	TropicBeauty	9
	Fla. 3–2	9
	Newbelle	8
	Forestgold	6
	Flordaprince	5
	Flordaglo	5
	Flordagem	4
	Flordastar	4
Nectarines	SunWright	8
	Fla. 82–17N	8
	Sunraycer	7
	Sunblaze	7
	Sunripe	6
Plums	Gulfruby	6
	Fla. 8–1	5

#### **Step 4. You may want to spread your risk and labour inputs over a range of different varieties chosen from Steps 1–3.**

In general, no one variety will suit the needs of the average grower. A selection of two, three or more varieties is recommended to spread the risk and workload.

Note: As new varieties will continually become available, our advice is to select the most appropriate varieties and then plant at the highest practicable density to concentrate your production for the first ten years into as small an area as possible. This makes it more practicable to net the orchard, improves your early cash flow per unit area and makes your management more efficient.

A word of advice — don't rely solely on our suggestions. Seek opinion from experienced extension officers, growers, nurseries, consultants and marketers. Growers investigating the export market should also consult exporters and export organisations.



Sources of advice  
Section 6 page 11

#### **Characteristics of the main varieties**

The *low chill stonefruit variety colour supplement* details the main features of the varieties we suggest you consider.



## New varieties for trial

New varieties are continually becoming available. We recommend that you trial new varieties in small numbers as they become available. This enables you to establish variety performance on your farm instead of accepting data from other areas at face value. Varieties we currently suggest for trial are listed in Table 7.

**Table 7.** Varieties currently suggested for trial

	Variety	Main features
<b>Peaches</b>	TropicSnow	Chilling units: 250. Maturity period: mid season (late October to mid November) Fruit features: freestone, round, reasonably shaped, medium to large size, creamy white skin (40% red blush), white non-browning flesh, outstanding flavour, very firm, highly resistant to bacterial spot, some suture bulge, can be hard to pick as it grows close to the branches. White flesh requires specialised marketing.
	Rayon	Chilling units: 175. Maturity period: late season. Fruit features: yellow flesh, freestone, very good skin colour (80% red colour), large size, reasonable shape, good flavour, tendency to be a little soft.
	Fla. 86-10	Chilling units 250. Maturity period: early season (between Flordaprince and TropicBeauty). Fruit features: yellow flesh, round shape, well coloured, reasonably firm.
	Fla. 88-3	Chilling units: 350. Maturity period: early season similar to Fla. 86-10. Fruit features: yellow flesh, round shape, well coloured, reasonably firm.
<b>Nectarines</b>	Sunmist	Chilling units: 350. Maturity period: mid season (early to late November). Fruit features: semi clingstone, well shaped, medium to large size, dull purple skin colour, yellow flesh, firm, highly resistant to bacterial spot. Very impressive in trials to date.
	Suncoast	Chilling units: 400. Maturity period: mid season (early to late November). Fruit features: semi clingstone, oval shape, large size, attractive skin colour, yellow flesh, firm, thick skin, good flavour, good resistance to bacterial spot.
	Fla. 87-4N	Chilling units: 250. Maturity period: early season (mid to late October). Fruit features: yellow flesh, similar fruit to Sunraycer with possible better size potential.
	Fla. 88-4N	Chilling units: 350. Maturity period: early season. Fruit features: yellow flesh, bright red skin colour.
	Fla. 90-3NW	Chilling units: 250. Maturity period: early season (possibly a week earlier than SunWright). Fruit features: white flesh, very attractive red skin colour.
<b>Plums</b>	Gulfblaze	Chilling units: 325 assigned by University of Florida but performs well in Australia at 150. Maturity period: early season (early to mid November). Fruit features: Excellent full dark-red colour, good size (larger than Gulfruby), flavour acceptable but only average, conical but uniform shape.
	Gulfbeauty	Chilling units: 250 assigned by University of Florida but performs well in Australia at 150. Maturity period: early season (late October). Fruit features: red flesh, good skin colour, moderate size (larger than Gulfruby), polliniser for Gulfruby.



## Nutrition

Good plant nutrition is one of the vital components of achieving good yields and fruit quality. Both deficiencies and excesses of plant nutrients can adversely affect fruit yield and quality. Fertiliser use has to be carefully managed to ensure a balanced supply of all nutrients is maintained. This is vital in low chill stonefruit because of the relatively short fruit development period of 80 to 100 days. Here are the important things you need to know:

Why nutrition needs to be carefully managed .....	33
The managed approach — monitoring nutrients .....	34
Understanding the important nutrients .....	34
A program for managing nutrition .....	36
Fertigation .....	43



### Why nutrition needs to be carefully managed

The unmanaged approach to fertilising low chill stonefruit involves applying fertiliser throughout the season without knowing whether the soil or the tree needs it or not. This can lead to excessively low or high levels of some nutrients in the soil and trees. This can cause several problems:

- reduced yields from nutrient imbalance;
- excessive leaf vigour, resulting in a reduction in fruit quality and production of replacement fruiting wood from shading, as well as increasing the amount of pruning;
- lower fruit quality from nutrient imbalance;
- greater susceptibility to fruit quality problems such as soft tip, postharvest browning and poor shape;
- out-of-season flowering and reduced production from early leaf fall;
- contamination of groundwater from excess nutrients being leached out of the root zone.

In addition, blanket fertiliser applications fail to recognise that different varieties, different blocks of trees and different soil types have different fertiliser needs. Consequently, a blanket fertiliser rate tends to be too much for some and too little for others.

Nutrient levels in both the soil and plant need to be more carefully monitored to avoid these problems. Nutrient monitoring improves

yield and fruit quality, reduces fertiliser cost and is kinder on the environment.

### **The managed approach — monitoring nutrients**

---

The modern approach to fertilising relies on regular monitoring of soil and plant nutrient levels so that nutrients are at all times kept at optimum levels for the plant. Three different monitoring tools are used:

- **Pre-plant soil analysis.** This ensures that firstly soils are suitable for the crop, and then that nutrient levels are at their optimum before planting. It is particularly important to allow for the adjustment of insoluble nutrients such as phosphorus and calcium, which are difficult to adjust once the trees are in the ground.
- **Annual leaf analysis in bearing trees.** This allows the fertiliser program to be fine-tuned each year to keep all nutrients within the optimum range. It allows variables such as the season, the crop load and the condition of the tree to be taken into account.
- **Regular, preferably annual, soil analysis in bearing trees.** This ensures that soil pH is kept within the desired range and monitors the important balance between pH, calcium, magnesium and potassium.

### **Understanding the important nutrients**

---

#### **Nitrogen**

Nitrogen is the key nutrient affecting yield and fruit size. Too little nitrogen reduces photosynthesis and hence leaf growth, causes early leaf fall and reduces fruit set. On the other hand, too much promotes excessive vigour, which by shading the inside of the tree, reduces fruit colour and the position of replacement fruiting laterals.

In young trees, nitrogen is applied regularly to grow the leaf canopy as quickly as possible. In bearing trees, it is applied annually with rates based on leaf analysis, crop removal figures and a visual assessment of vigour. Nitrogen is best applied in three applications:

- one at budbreak to assist in fruit development;
- another after harvest to grow a strong summer flush and build up the energy reserves for the next crop;
- a third application in autumn to help hold the leaves on and to supplement the storage of energy reserves in the wood over winter.

#### **Phosphorus**

Like most tree crops, low chill stonefruit has a low requirement for phosphorus, particularly in the sandy loam soils where much of the low chill stonefruit is grown. As phosphorus is readily available in these soils, deficiencies are rare. The only situation where regular application

may be necessary is in heavier clay soils where phosphorus becomes fixed and unavailable to the tree. Here, banding of phosphorus fertiliser in a one-metre-wide strip along the tree row will generally meet the tree's needs for several years. Base the calculation of timing and rates on leaf and soil analysis and crop removal figures.

### **Potassium**

After nitrogen, potassium is the next most important nutrient for low chill stonefruit. It is a major component of fruit and, if deficient, has a significant impact on fruit size and quality. Too much potassium may lead to imbalances with calcium and magnesium.

Annual applications of potassium fertiliser may be necessary, with most or all applied between budbreak and harvest to help build size in the developing fruits. Base rates on leaf and soil analysis and crop removal figures.

### **Calcium and magnesium**

While the need for calcium is high, calcium deficiency is rare. Problems develop only where soil pH is low or where excessive leaf growth from high nitrogen levels reduces calcium uptake. Where calcium levels become too high, the uptake of magnesium and potassium can be significantly reduced.

Magnesium is not required in large amounts, and deficiency is rare, except in the leached, acid, sandy soils of the coast. Again, high levels can interfere with the uptake of calcium and potassium.

Because of the links between pH, calcium, magnesium and potassium, base the calculation of timing and rates of these nutrients on leaf and soil analysis. Corrective application is generally only necessary once every few years. Aim to keep the soil pH around 5.5 (1:5 water) or slightly lower for krasnozems soils.

Where pH needs raising, only use dolomite where both calcium and magnesium are low and the ratio of calcium to magnesium is greater than 6:1. Otherwise use lime. Make sure the lime or dolomite used has a high neutralising value and a high degree of fineness.

Where pH is at the correct level or higher, use gypsum to correct a calcium deficiency and magnesium oxide to correct a magnesium deficiency.

All liming materials are best applied in autumn.

### **Trace elements**

Zinc and boron are the main trace elements affecting yield and quality of low chill stonefruit. As both nutrients do not easily re-translocate within the tree, there must be either a ready supply from the soil or from foliar sprays. Use leaf and soil analysis to monitor levels. Where foliar sprays are used, apply these to the developing spring flush.

## A program for managing nutrition

### Before planting

Do a complete soil analysis before planting to enable all nutrients to be adjusted to their appropriate levels throughout the intended root zone. This is particularly important for the relatively insoluble nutrients such as phosphorus, calcium, zinc and copper as these are best applied to the soil surface and then worked into the entire root zone. It is difficult to do this after the trees have been planted.

Get the results of the soil analysis interpreted by the laboratory analysing your samples, an agronomist or nutrition consultant. They will recommend appropriate fertilisers and rates to bring the levels of all nutrients within the desired ranges. The optimum soil nutrient levels to aim for are shown in Table 8.

**Table 8.** Optimum soil nutrient levels for low chill stonefruit

Element	Optimum soil levels
pH (1:5 water)	5.5 – 6.5 (5.0 – 5.5 for krasnozem soils)
pH (1:5 CaCl <sub>2</sub> )	4.5 – 5.0
Organic carbon (Walkley-Black)	more than 2.0% C
Nitrate nitrogen (1:5 aqueous extract)	more than 20 mg/kg
Phosphorus (Colwell)	60 – 100 mg/kg P
Potassium (exchangeable)	more than 0.5 meq/100 g K
Calcium (exchangeable)	more than 5 meq/100 g Ca
Magnesium (exchangeable)	more than 1.6 meq/100 g Mg
Sodium (exchangeable)	less than 1 meq/100 g Na
Chloride (1:5 aqueous extract)	less than 250 mg/kg Cl
Conductivity (1:5 aqueous extract)	less than 2 dS/m
Copper (DPTA)	0.3 – 10 mg/kg Cu
Zinc (DPTA)	2 – 10 mg/kg Zn
Manganese (DPTA)	4 – 45 mg/kg Mn
Iron (DPTA)	more than 2 mg/kg Fe
Boron (hot calcium chloride)	0.5 – 1 mg/kg B
Calcium:magnesium ratio	3 – 5:1
Total cation exchange capacity	more than 7
Cation balance (%)	calcium 65 – 80; magnesium 10 – 15; potassium 1 – 5; sodium less than 5

### Young, non-bearing trees

If nutrient levels were adjusted properly before planting, there will be little need to apply any fertiliser other than nitrogen for the first one to two years.

Don't start fertilising until the young trees have begun to put on new growth. Then fertilise little and often, at least once every six to eight weeks from September to May. For each application, use about 10 to 15 kg/ha of urea or nitram. Avoid using sulphate of ammonia.

Spread the fertiliser in a broad ring around the tree extending 50 cm beyond the canopy. Keep the fertiliser 10 cm away from the trunk to avoid collar burn. Alternatively, apply through the irrigation system (fertigation).

## Bearing trees

From bearing onwards (normally considered from the second or third year), base all fertiliser application on leaf and soil analysis. In addition, consider crop removal figures for calculating nitrogen, phosphorus and potassium rates, and factor in tree vigour in the nitrogen calculation. Do leaf and soil analysis each year about two weeks after harvest and before summer pruning or fertiliser application.

## Leaf analysis

Separate the orchard into trees of different varieties and different ages and where possible, take separate samples for each. Buy leaf sampling kits from your farm supply store and follow the instructions. Take leaf samples from trees representative of the variety and tree age — not from trees on the edge or trees under stress. In a palmette orchard, sample two leaves from each of 50 trees, one from each side of the row. In an open vase orchard, sample four leaves from each of 20 trees, one from each of the four sides of the tree. The correct leaves to sample are mature leaves from the midpoint of exposed shoots from the current season's terminal growth (Figure 12). After sampling, keep leaves cool and send to the analysis laboratory as soon as possible.

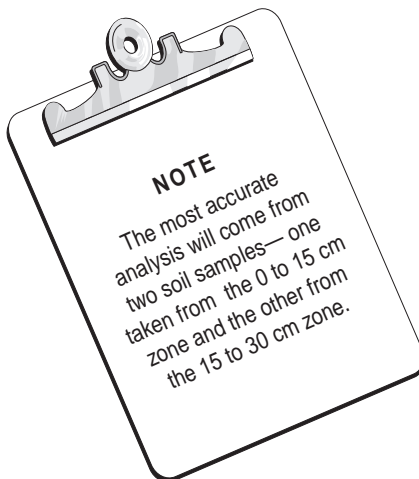


*Figure 12. Correct leaves to sample for leaf analysis*

## Soil analysis

Buy soil sampling kits from your farm supply store and follow the instructions.

The traditional soil sample is taken from a depth of between 0 and 15 cm. However, many low chill stonefruit soils are acidic and contain low levels of available phosphorus. For this reason, lime and superphos-



phate are regularly applied and accumulate in the top 15 cm of soil. If this zone alone is sampled, it will distort the picture for the rest of the root zone. We recommend you take two soil samples — one from the 0 to 15 cm zone, and the other from the 15 to 30 cm zone. If only one sample is taken, sample the entire 0 to 30 cm zone.

To obtain your sample(s), take a reasonably uniform area of the orchard which is typical of most of the trees. If there is an obviously different area, sample it separately. Sample about 15 sites from each uniform area, taking the samples from under the tree canopies but no closer than 30 cm from the trunks, and within the wetted area of the sprinklers (Figure 13). Use a soil auger or spade to take samples, and store them in a bucket. Use two buckets if sampling at the two recommended depths. If lime, dolomite, gypsum or other fertilisers have been applied recently, scrape away a thin layer of soil before sampling.



Sample from under tree canopy, within the wetted area of the sprinkler, and no closer than 30 cm from the tree butt.

Sample to at least 30 cm or take two samples; the first, 0 – 15 cm and second, 15 – 30 cm.

**Figure 13.** How to sample for soil analysis

When all 15 samples have been collected, mix the soil together and remove about a cupful for analysis. Do this by taking pinches of soil periodically during the mixing process. Place the cupful portion on clean newspaper or plastic sheeting in the shade for a few hours to air-dry. Place the air-dried soil in the plastic sample bag provided with your test kit. Send to the laboratory as soon as possible. A full soil test including pH, electrical conductivity, phosphorus, potassium, calcium, magnesium, sodium, aluminium and trace elements is recommended.

### Interpretation of leaf and soil analysis results

The laboratory analysing your soil samples will interpret the results and provide recommendations of appropriate fertilisers and rates to bring



'Replacement rates'  
This section  
pages 40–41

the levels of all nutrients within the desired ranges. If you want to do this yourself, or at least understand how it is done, Tables 9 and 10 provide broad guidelines to interpreting leaf and soil analysis results. The tables use a concept known as 'replacement rates' which is explained later in this section.

**Table 9.** *Interpreting soil analysis results*

Element	Desired levels	Interpretation
pH (1:5 water)	5.5 – 6.5 (5.0 – 5.5 for krasnozems soils)	5.5 is about ideal. If below 5.5, apply dolomite if calcium:magnesium ratio (in this table) is close to 3 – 5:1. Otherwise use lime.
pH (1:5 CaCl <sub>2</sub> )	4.5 – 5.0	4.6 is about ideal. If below 4.6, apply dolomite if calcium:magnesium ratio ((in this table) is close to 3 – 5:1. Otherwise use lime.
Organic carbon – %C (Walkley-Black)	2.0 – 5.0	If less than 2, use green manure crops, mulches, and organic manures.
Nitrate nitrogen – mg/kg (1:5 aqueous extract)	more than 20	If less than 20, apply at replacement rates + 30 to 50% if losses are expected. If 20 to 60, apply at replacement rates. If more than 60, apply less than replacement rates.
Phosphorus – mg/kg P (Colwell)	60 – 100	If less than 60, apply at rate of 30 kg/ha phosphorus; more if losses are expected. If 60 to 100, apply at replacement rates. If more than 100, no application is necessary.
Potassium – meq/100 g K (exchangeable)	more than 0.5	If less than 0.5, apply at replacement rates + 20 to 30% if losses are expected. If 0.5 to 1, apply at less than replacement rates. If more than 1, no application is necessary.
Calcium – meq/100 g Ca (exchangeable)	more than 5	If less than 5, apply lime, dolomite or gypsum depending on pH and calcium:magnesium ratio. If more than 5 and pH is more than 5.3, no application is necessary.
Magnesium – meq/100 g Mg (exchangeable)	more than 1.6	If less than 1.6, with pH more than 5.3 and calcium:magnesium ratio 4, no application is necessary. If more than 1.6, with pH more than 5.3 and calcium:magnesium ratio 4, apply magnesium oxide at 100 to 200 kg/ha.
Sodium – meq/100 g Na (exchangeable)	less than 1	If more than 1, check quality of irrigation water and height of water table.
Chloride – mg/kg Cl (1:5 aqueous extract)	less than 250	If more than 250, check quality of irrigation water and height of water table and use sulphate forms of potassium fertiliser.
Conductivity – dS/m (1:5 aqueous extract)	less than 2	If more than 2, check quality of irrigation water, fertiliser rates and height of watertable.
Copper – mg/kg Cu (DPTA)	0.3 – 10	Rarely out of adequate range.
Zinc – mg/kg Zn (DPTA)	2 – 10	If less than 2, check leaf analysis level to see if overall deficiency is confirmed. Follow recommendations there.
Manganese – mg/kg Mn (DPTA)	4 – 45	Rarely out of adequate range.
Iron – mg/kg Fe (DPTA)	more than 2	Rarely out of adequate range.
Boron – mg/kg B (hot calcium chloride)	0.5 – 1	If less than 0.5, check leaf analysis level to see if overall deficiency is confirmed. Follow recommendations there.
Calcium:magnesium ratio	3 – 5: 1	See pH, calcium and magnesium above.
Total cation exchange capacity	more than 7	See pH, calcium, magnesium and potassium above.
Cation balance (%)	calcium 65 – 80; magnesium 10 – 15; potassium 1 – 5; sodium less than 5	See pH, calcium, magnesium and potassium above



**Table 10.** *Interpreting leaf analysis results*

Nutrient	Desired range		Interpretation
	Not Cultar-treated	Cultar-treated	
Nitrogen (% N)	3.49 – 3.71	2.96 – 3.18	If below desired levels, may indicate insufficient fertiliser, poor application or root damage. Use soil analysis results to determine rates of application. If within or above desired range, use soil analysis results to determine rates of application.
Sulphur (% S)	0.18 – 0.2	0.18 – 0.2	Rarely out of range.
Phosphorus (% P)	0.23 – 0.32	0.17 – 0.26	If within desired range, no action necessary. If below or above desired range, use soil analysis results to determine rates of application.
Potassium (% K)	2.23 – 2.64	2.23 – 2.64	If below desired levels, may indicate insufficient fertiliser or competition for uptake with high levels of calcium and/or magnesium. Use soil analysis results for potassium, calcium and magnesium to determine rates of application. If within or above desired range, use soil analysis results to determine rates of application.
Calcium (% Ca)	1.23 – 1.56	1.53 – 2.03	If below desired range, may indicate low soil pH, insufficient calcium fertiliser or an imbalance with potassium and/or magnesium. Use soil analysis results for potassium, calcium, magnesium and pH to determine type of fertiliser and rates of application. If within or above desired range, no action necessary.
Magnesium (% Mg)	0.33 – 0.37	0.58 – 0.62	If below desired range, may indicate low soil pH, insufficient magnesium fertiliser or an imbalance with potassium and/or calcium. Use soil analysis results for potassium, calcium, magnesium and pH to determine type of fertiliser and rates of application. If within or above desired range, no action necessary.
Zinc (ppm Zn)	28 – 32	28 – 32	If below desired range, may indicate high soil pH, excessive phosphorus or excessive nitrogen. If soil levels also low, apply zinc sulphate monohydrate to the soil under the trees at a rate of 2 to 3 g/sq.m. of soil surface beneath the trees. Alternatively, apply a foliar spray of zinc sulphate heptahydrate (1 kg) + hydrated lime (500 g) per 100 L water in early summer; or a dormant season (after pruning but before applying winter oil) spray of zinc sulphate heptahydrate at 2.5 kg/100 L water. If within or above desired range, no action necessary.
Copper (ppm Cu)	7.9 – 10.9	7.9 – 10.9	Rarely out of range if copper sprays are used for leaf curl control.
Sodium (% Na)	0.011	0.011	If more than desired level, check quality of irrigation water and soil analysis results.
Chloride (% Cl)	0.04 – 0.06	0.09 – 0.11	If more than desired range, check quality of irrigation water and soil analysis results.
Iron (ppm Fe)	45 – 160	45 – 160	Rarely out of range except where heavy applications of lime or dolomite have been made.
Boron (ppm B)	29 – 47	29 – 43	If below desired range, apply 1 to 2 g/sq.m. of borax or 0.5 to 1 g/sq.m. of Solubor to the soil surface beneath the trees. If within or above desired range, no action necessary.
Manganese (ppm Mn)	46 – 162	46 – 162	Rarely out of range where mancozeb is regularly sprayed for leaf diseases. If below desired range, apply a foliar spray of manganese sulphate at 100 g/100 L at petal fall.

### Fertiliser rates using the nutrient replacement concept

Once you have worked out what nutrients require adjustment, the next step is to calculate the rates of fertiliser that need to be applied. For the main nutrients, we recommend you use the nutrient replacement concept. This bases fertiliser application rates on how much nutrient is removed by the tree, adjusted by the expected losses of nutrient through leaching and soil fixation.

The starting point is determining nutrient removal by the tree. This has been calculated from research and is shown in Table 11.

**Table 11.** Nutrient removal by trees with varying crop yields (based on mature palmette trees at a density of 1000 trees/ha)

Crop yield (tonnes/ha)	Total tree nutrient removal (kg/ha)				
	Nitrogen	Phosphorus	Potassium	Calcium	Magnesium
5	19.9	2.1	20.6	13.1	2.7
10	26.3	2.8	29.1	13.4	3.2
15	32.7	3.6	37.5	13.8	3.6
20	39.1	4.3	46.0	14.1	4.1
25	45.5	5.1	54.4	14.4	4.5
30	51.9	5.9	62.9	14.7	5.0

Depending on your soil type and situation, these figures can be adjusted for leaching, fixation and soil washing effects. The following losses could be expected:

- 30 to 50% of nitrogen lost by leaching, the higher levels occurring in sandy soils;
- 20 to 30% of potassium and magnesium lost by leaching, the higher levels occurring in sandy soils;
- 50 to 80% of phosphorus lost by fixation, the higher levels occurring in red krasnozem soils;
- 5 to 20% of phosphorus and calcium lost by soil washing away in runoff, the higher levels occurring in erodible sandy soils.

Because soil type and weather conditions vary so much, we recommend you adjust your rates to suit your particular set of conditions. The following rule of thumb can be applied in most situations:

- increase nitrogen rates by 30%;
- increase phosphorus rates by 100%;
- increase potassium rates by 30%;
- increase calcium rates by 10%;
- increase magnesium rates by 25%.

Based on this rule of thumb, the adjusted requirements for full nutrient replacement for the yield ranges in Table 11 are shown in Table 12.

**Table 12.** Nutrient requirements for full replacement (tree nutrient removal + adjustment for leaching and other losses — based on mature palmette trees at a density of 1000 trees/ha)

Crop yield (tonnes/ha)	Nutrient requirements for full replacement (kg/ha)				
	Nitrogen	Phosphorus	Potassium	Calcium	Magnesium
5	26	4	27	14	3
10	34	6	38	15	4
15	43	7	49	15	5
20	52	8	60	15	5
25	60	10	70	16	6
30	67	12	82	16	6

## A fertiliser program

Once you have worked out nutrient replacement rates, go back to the leaf and soil analysis interpretation in Tables 9 and 10 and work out a fertiliser program. An example for an orchard yielding a crop of 25 t/ha and using full nutrient replacement rates is shown in Table 13. Note that the annual requirement for nitrogen is broken up into three applications — in July, November and March. The November application may be evenly split into two applications — one in November and the other in January. This provides a measure of insurance against the one application being lost by leaching from heavy summer rain. Other nutrients are applied with the nitrogen for convenience at one or two of the application times.

**Table 13.** Fertiliser program for an orchard yielding 25 t/ha

	July	November	March	Total
Nitrogen	21 kg/ha	18 kg/ha	21 kg/ha	60 kg/ha
Phosphorus			10 kg/ha	10 kg/ha
Potassium	35 kg/ha		35 kg/ha	70 kg/ha
<b>Orchard on palmette — density of 1000 trees per hectare (spacing 4.0 m x 2.5 m)</b>				
<b>Either</b>				
mixed fertiliser 12:5:14 N:P:K	175 g/tree	150 g/tree	175 g/tree	500 g/tree
<b>Or</b>				
straight fertilisers:				
urea	50 g/tree	40 g/tree	50 g/tree	140 g/tree
superphosphate			120 g/tree	120 g/tree
muriate of potash	70 g/tree		70 g/tree	140 g/tree
<b>Orchard on open vase — density of 400 trees per hectare (spacing 5.0 m x 5.0 m)</b>				
<b>Either</b>				
mixed fertiliser 12:5:14 N:P:K	435 g/tree	370 g/tree	435 g/tree	1240 g/tree
<b>Or</b>				
straight fertilisers:				
urea	120 g/tree	100 g/tree	120 g/tree	340 g/tree
superphosphate			300 g/tree	300 g/tree
muriate of potash	175 g/tree		175 g/tree	350 g/tree

Apply calcium, magnesium and trace elements according to leaf and soil analysis results.

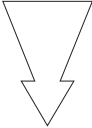
## Fertiliser choice

We recommend the use of manufactured fertilisers as they produce a more predictable and timely response. Organic fertilisers are useful in improving soil structure, organic matter levels and microbial activity. They are recommended as supplements to the manufactured fertilisers for this purpose.

Within manufactured fertilisers, straight fertilisers are preferred as they allow a more individual response to the needs of each nutrient. They are also generally cheaper per unit of nutrient. Mixed fertilisers are more convenient to use but may cause a nutrient imbalance by oversupplying a particular nutrient.

Another important issue in the selection of fertilisers is how much they will contribute to soil acidity and soil salinity. If your soil is acid, choose the least acidifying fertiliser available. Common fertilisers are rated in Table 14.

**Table 14.** Acidifying effect of common fertilisers

Fertiliser	Acidifying effect
MAP	highly acidifying
Sulphate of ammonia	
DAP	
Urea	
Nitram	
Superphosphate	
Muriate of potash	non acidifying

Most mixed fertilisers are based on sulphate of ammonia and therefore acidify the soil.

If you have a salinity problem, choose fertilisers with the lowest salt index. Common fertilisers are rated in Table 15.

**Table 15.** Salt index of common fertilisers. (For comparison, common salt has a salt index of 154)

Fertiliser	Salt index
Muriate of potash	114
Nitram	105
Urea	75
Potassium nitrate	74
Sulphate of ammonia	69
Sulphate of potash	46
DAP	34
MAP	30
Gypsum	8
Superphosphate	8
Lime	5
Dolomite	1

## Fertiliser placement

Mature tree roots extend into the middle of the row so the whole orchard should receive some fertiliser. Set up the fertiliser spreader to place most of the fertiliser under the tree canopy.

## Fertigation

Fertigation (application of fertiliser through the irrigation water) is recommended and has many advantages over the manual application of solid fertilisers. It uses less labour, there is more efficient nutrient uptake and fertilisers can be applied more regularly and conveniently. With efficient fertigation, annual rates of nitrogen can generally be reduced by up to 50% and annual rates of potassium by up to 25%.

With fertigation, fertiliser is dissolved in water in a drum or tank and sucked or injected through the watering system. The preferred equipment is a venturi injection pump or a pressure differential system. Fertilisers used must be highly soluble to avoid pump damage and pipe blockages. Mixtures of fertiliser must also be compatible to avoid the development of precipitates which can block sprinklers and also cause root damage. Other major requirements are good filtration and a uniform irrigation system which delivers similar amounts of water to all trees in the orchard.

The most suitable fertilisers for fertigation are listed in Table 16.

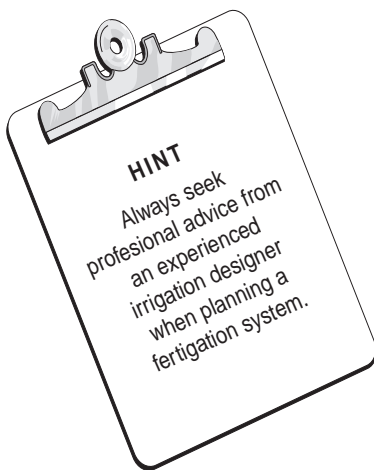
**Table 16.** Soluble fertilisers for fertigation

Fertiliser	Main nutrient supplied
Urea	Nitrogen
Calcium nitrate	Nitrogen, calcium
Potassium nitrate	Potassium, nitrogen
Potassium chloride	Potassium
MAP (technical grade)	Phosphorus, nitrogen

Several suitable commercial soluble fertilisers that supply a range of nutrients are also available. These include Flowfeed and Liquifert.

You can fertigate every time you water if you wish, but once every fortnight or month is sufficient and most practical. Before you start fertigating, get a water testing laboratory to fully analyse your irrigation water. Make sure an iron test is included.

When fertigating, inject the fertiliser during the last third of the irrigation period. After injection is completed, continue watering for a short time to wash any fertiliser residues out of the irrigation system.





## Irrigation and monitoring

*Although the trees may not show it, water stress at critical times in the development of the crop can dramatically affect fruit yield and quality. Careful management of irrigation is a key factor in achieving good orchard performance. Here are the main things you need to know:*

The importance of getting irrigation right .....	45
Irrigation must No. 1 — a good irrigation system .....	46
Irrigation must No. 2 — a monitoring system .....	46
Tensiometers .....	48
Soil moisture sensors .....	52
The neutron probe .....	52
Capacitance probes .....	53
Evaporation pan .....	54
Tips for managing with limited water .....	55

### **The importance of getting irrigation right**

Stonefruit have a high seasonal water requirement, particularly when compared with other tree crops such as citrus and macadamia. There are three critical periods when too little water may cause major fruit yield and quality problems:

- Two weeks before to three weeks after fruit set. This is the period when the young fruit is undergoing rapid cell division. The number of cells formed here determines the potential fruit size. Water stress at this stage reduces cell division and hence final fruit size. It may also increase fruit drop.
- Two to four weeks before harvest. This is the fruit filling period where fruit cells formed at fruit set expand. Water stress at this stage reduces fruit size and may lead to skin cracking.
- Summer growth flush and flower bud initiation (December to March). Water stress at this time reduces flower bud initiation and, by reducing the health and vigour of the summer flush, leads to early leaf fall.

To guard against the problem of underwatering, it is easy to go to the other extreme and apply too much. This reduces yield through

reducing soil aeration, increases the incidence of root and collar rot diseases and reduces fruit quality. Overwatering just before harvest also increases the incidence of split stone. Another major problem is that overwatering leaches fertiliser out of the root zone. This wastes fertiliser and poses a serious environmental hazard of polluting groundwater with excessive amounts of nutrients.

### **Irrigation must No. 1 — a good irrigation system**

The first essential requirement of efficient irrigation is a water supply and irrigation system capable of delivering the required amounts of water when needed without wasting your scarce water resource.

The best way to do this is to get a qualified irrigation designer to prepare an irrigation design plan. There are two preferred irrigation systems on which the plan can be based:

- Under-tree minisprinklers with a micro-spray feature. The micro-spray feature is used for the first two years to limit water throw. Use sprinklers with an output of 80 to 250 litres per hour. Remember, in the design of the irrigation system, to allow capacity for the extra sprinklers to water your windbreak trees.
- Trickle systems (either T-tape or Netafim buttons). For young trees, use one row of T-tape. When trees are about three to four years old, install a second row of tape on the other side of the tree row. With buttons, use two eight-litre emitters per tree. Trickle systems need to be well designed to operate effectively and must be properly maintained to prevent blockages. High level filtration with sand filters is essential. Although trickle watering requires more careful management, it has some significant advantages. It uses much less water, provides more efficient wetting of the root zone and can be used to apply soluble fertilisers directly into the root zone.

Whatever system you use, it must be able to supply water to a depth of about 150 cm, the normal depth that roots reach in the soil profile.

### **Irrigation must No. 2 — a monitoring system**

The second essential requirement of efficient irrigation is a system to tell you when and how much water your crop needs. This is known as a monitoring or scheduling system. The importance of monitoring is confirmed by research which shows that with monitoring, water use can generally be reduced without affecting yield and fruit quality. It also makes sure you are applying enough water at the critical times and not overdoing it at other times.

A range of equipment and techniques is available for monitoring soil moisture and scheduling irrigation. The most common are the soil based systems using tensiometers, soil moisture sensors, neutron soil moisture probes or soil capacitance systems such as the Enviroscan. Another technique is a climate-based system that uses estimates of



Irrigation consultants  
Section 6 page 7

evapotranspiration. The soil based systems are preferred and recommended. A brief comparison of the main systems is shown in Table 17.

Most of the roots of stonefruit trees are in the top 75 cm of soil, so soil water monitoring devices used for irrigation scheduling need to concentrate on this part of the soil profile.

As soil moisture monitoring can be complex, we recommend you seek expert advice, particularly when setting up the system.

**Table 17.** Comparison of main soil moisture monitoring systems

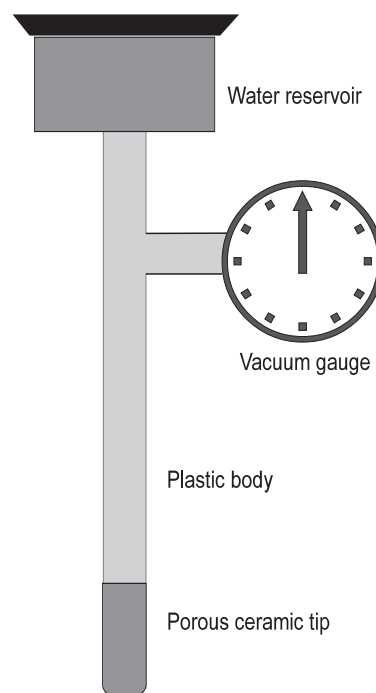
System	Advantages	Disadvantages
Tensiometers	<ul style="list-style-type: none"> <li>• Relatively cheap</li> <li>• Easy to install yourself</li> <li>• Can be read by yourself</li> <li>• Allows continuous monitoring</li> </ul>	<ul style="list-style-type: none"> <li>• Labour intensive to collect and record data</li> <li>• Require regular maintenance</li> <li>• Can be inaccurate in extremely wet or dry soil</li> <li>• Less accurate in the top 10 cm of soil</li> </ul>
Soil moisture sensors e.g. gypsum blocks	<ul style="list-style-type: none"> <li>• Relatively cheap</li> <li>• Easy to install yourself</li> <li>• Can be read by yourself</li> <li>• Continuous monitoring possible</li> </ul>	<ul style="list-style-type: none"> <li>• Labour intensive to collect and record data. Requires a digital meter to be brought to each sensor site to take readings.</li> <li>• Can be inaccurate in extremely wet or dry soil</li> <li>• Less accurate in the top 10 cm of soil</li> </ul>
Neutron probe	<ul style="list-style-type: none"> <li>• Portable, can be moved around sites</li> <li>• Very reliable and accurate</li> </ul>	<ul style="list-style-type: none"> <li>• Not suitable for continuous monitoring</li> <li>• As equipment is expensive and radioactive, generally used by a consultant who owns the equipment</li> <li>• Less accurate in the top 10 cm of soil</li> <li>• Less accurate in sandy soil because of low sampling frequency</li> </ul>
Capacitance probes e.g. Enviroscan	<ul style="list-style-type: none"> <li>• Continuous monitoring</li> <li>• Accurate at all depths and for all soils</li> <li>• Enables rapid reading and recording of results</li> </ul>	<ul style="list-style-type: none"> <li>• Expensive</li> <li>• Needs skill in interpreting data</li> </ul>
Evaporation pan	<ul style="list-style-type: none"> <li>• Inexpensive. No in-field measurement is needed because the system uses weather data to predict irrigation need</li> <li>• Regular schedules can be developed in advance</li> </ul>	<ul style="list-style-type: none"> <li>• Less accurate as system ignores soil variability and the performance of the irrigation system</li> <li>• Cannot assess the effectiveness of rainfall received</li> </ul>



## Tensiometers

Tensiometers, provided they are well sited and maintained, are a relatively cheap and effective way of monitoring soil moisture.

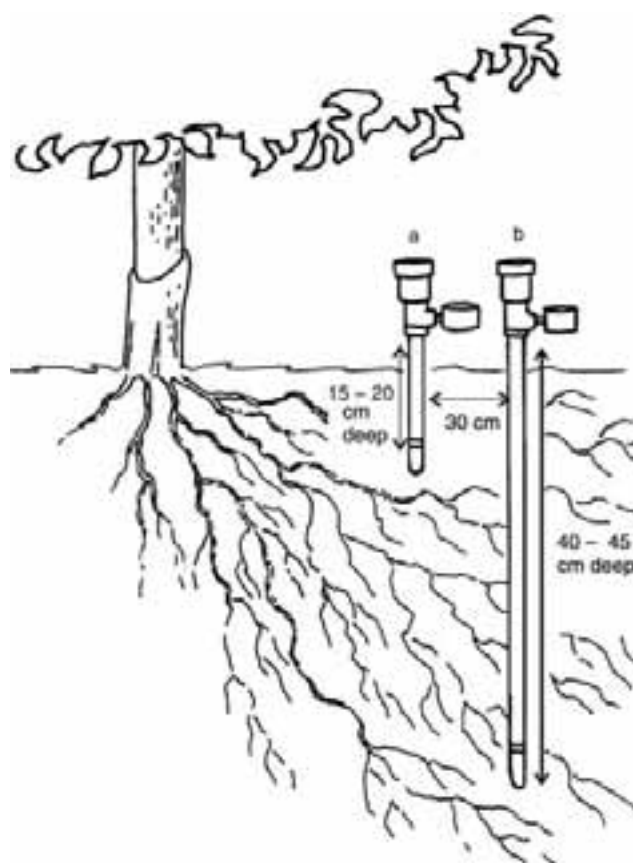
A tensiometer consists of four basic parts — a hollow tube filled with water and algaecide, a ceramic tip, a water reservoir and a vacuum gauge which reads water tension on a scale of 0 to 100 centibars or kilopascals (kPa) (Figure 14 ). In saturated soil, the vacuum gauge displays 0 kPa. As the soil dries over several days, water moves from inside the instrument, through the porous ceramic tip, into the soil. The gauge reading steadily increases to a maximum of about 90 kPa. When the soil is re-wet after rain or irrigation, water moves from the soil back into the tensiometer and gauge readings fall.



**Figure 14.** Parts of a standard tensiometer

## Monitoring sites

Tensiometers are installed at monitoring sites throughout the orchard once trees are established. They are then left in place. Use at least one monitoring site for each variety or block. At each site, install two tensiometers — one 30 cm long tensiometer installed in the major root zone at a depth of about 15 to 20 cm, and one 60 to 90 cm long tensiometer below most of the roots at a depth of about 45 cm. Place tensiometers on the north-eastern side of trees, inside the dripline and at least 15 cm from the trickle tube. Placement of tensiometers is shown in Figure 15.



**Figure 15.** Tensiometers in place, (a) in major root zone and (b) below most roots

### Installation

Assemble tensiometers and fill with good quality water to which algaecide has been added. Adding a dye to the water also makes it easy to observe the water level. Leave them to stand in a bucket of water at least overnight, but preferably for one to two days. The water does not need to be pre-boiled. Tensiometers are more reliable if a vacuum pump is used to remove any air from the tensiometer body and gauge. Make sure the pump fits snugly over the fill point on top of the tensiometer. Top up the tensiometers with more water if necessary and use the vacuum pump to remove any air bubbles. They are now ready to install.

The two main principles when installing tensiometers are:

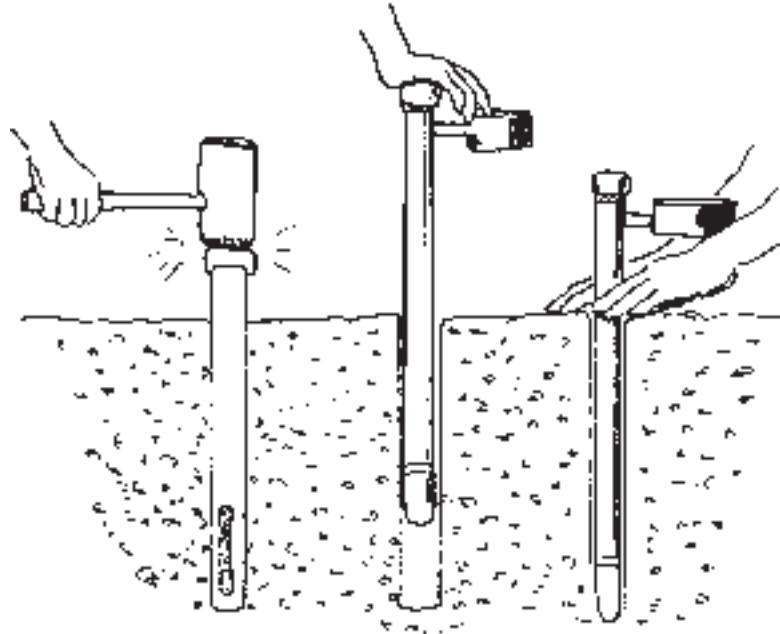
- good contact between the soil and ceramic tip
- no easy pathways for water to flow directly from the soil surface to the tensiometer tip.

Carry tensiometers to the installation site with the tips either in water or wrapped in wet rags. Do not touch the porcelain tips with the fingers as grease from the fingers can block the fine pores. Provided the ground is moist and well cultivated, the shallow tensiometer can be pushed into the soil to the required depth of 15 to 20 cm. Don't push too hard. The tips are strong, but can crack under excessive pressure. Only

experience teaches how hard is too hard. At \$30 per tip, this is an expensive lesson. If you encounter a hard soil layer, either take the tensiometer out and try somewhere else, or use the deep tensiometer procedure.

To install the deep tensiometer, follow these instructions in conjunction with Figure 16. Dig a hole to the required depth and keep the excavated soil nearby in a pile. We have found a 50 mm (two inch) auger the best tool. Place the tensiometer in the hole, over to one side. The next step is critical. Good contact between the ceramic tip and the surrounding soil is most important. Take the most crumbly, moist soil from the dirt pile and pack it around the tip at the base of the hole. A piece of 10 to 15 mm diameter dowel is useful for packing. Don't overcompact the soil into plasticine, but remove large air gaps. Continue replacing soil until the hole is filled. It doesn't matter which soil you use after you have packed the first 5 cm above the tip. Friable topsoil from a few metres away can be used to create a slight mound around the tensiometer. This minimises the risk of water draining down beside the tensiometer, leading to false readings.

Covers made from silver/blue insulation foil can be placed over the tensiometers to minimise temperature fluctuations and algal growth. The gauge can be left exposed for easy reading.



**Figure 16.** *Installing deep tensiometers*

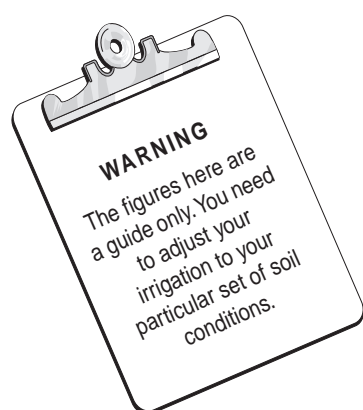
The tensiometers are now ready to operate. Use the vacuum pump to remove air bubbles. Tensiometers may take a few irrigation cycles to settle down, so don't take too much notice of the readings for the first few days. During this period, air gaps may appear in the tensiometer. Simply refill with algacide-treated water. Within a week of installation, readings should rise and fall with irrigation or rainfall.

Clearly mark tensiometer locations to avoid damage from tractors and other equipment.

## Reading

Read tensiometers early in the morning, before 8 a.m., and preferably at the same time each day. At this time there is little water movement in the soil or plant. Read at least twice a week but preferably every day or second day. Lightly tap the gauge before reading. It is best to read the tensiometers daily for the first few weeks to get a feel for the system.

The shallow tensiometer indicates when to water. The deep tensiometer indicates when the right amount of water has been applied.



## Irrigating using tensiometers

Start watering when the shallow tensiometer reads 20 kPa (sandy soils) and 30 to 40 kPa (loam and clay loam soils). Stop watering when the reading on the deep tensiometer falls to 10 kPa. Slightly lower readings should be used for trickle systems. Reposition tensiometers every second year in winter to the new dripline position. Once a week, remove any accumulated air and check that gauges are working using the vacuum pump. Refill tensiometers with clean water.

## Troubleshooting tensiometer problems

### No water in the tensiometer; gauge reads 0

There is either a crack in the ceramic tip or a faulty seal. Fill the tensiometer with water and apply suction with the vacuum pump. A stream of large bubbles will indicate the problem area; usually a cracked tip or a missing o-ring.

### Air entering over several days; gauge registering more than 5

There is either a hairline crack in the tip or a substantial air gap in the soil around the tip. Remove the tensiometer. If there are no obvious tip cracks, re-install it. If the problem persists, replace the tip.

### No change in readings over several days

The gauge may be faulty or blocked. Check the gauge is working by:

- applying suction to the tensiometer with the vacuum pump, or
- removing the gauge, rinsing with clean water and sucking it. If the needle does not move, the gauge is faulty and should be replaced.

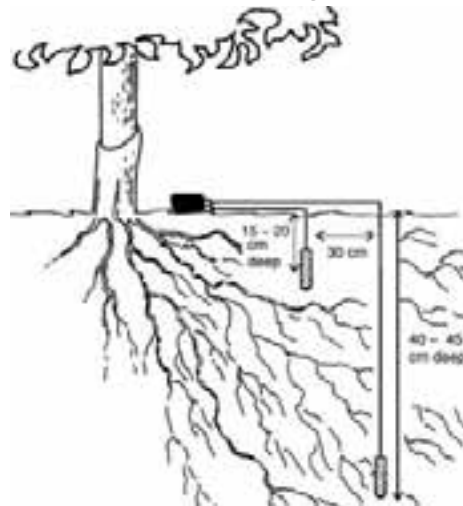
### Tensiometer readings increase beyond 80 then fall to 0, accompanied by air in the tensiometer

The soil has become too dry for the tensiometer to operate. After irrigation, refill the tensiometer and treat as if it had just been installed. If this happens frequently, consider whether you are under-irrigating. If you are happy with your irrigation scheduling, try installing the shallow tensiometer slightly deeper. This problem should never occur with the deep tensiometer.

## Soil moisture sensors

These devices consist of blocks of gypsum which are buried in the soil at strategic points and allowed to assume the same moisture content as the surrounding soil. A pair of wires hooked to the blocks are left exposed at the soil surface and a digital ohmmeter is connected when a reading is desired. The electrical resistance recorded by the ohmmeter is measured as water tension in centibars or kilopascals (kPa).

Monitoring sites for the blocks are set up in a similar manner to those for tensiometers with two blocks at each site — one at a depth of about 20 cm and the other at a depth of about 40 to 50 cm. Positioning of the blocks is similar to that shown for tensiometers. The gypsum blocks can be installed in holes similar to those used for tensiometers. Again there must be good contact between the blocks and the surrounding soil and the hole filled to the soil surface. See Figure 17 .



**Figure 17.** Placement of gypsum blocks

Irrigating using gypsum blocks is similar to that recommended for tensiometers as the device is recording the same soil tension readings.

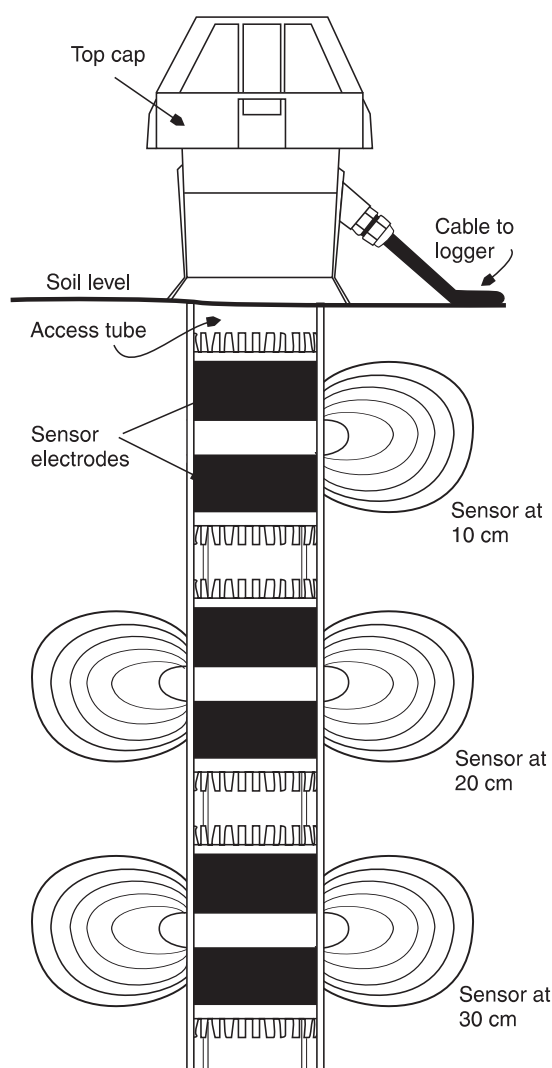
## The neutron probe

The neutron probe is a sophisticated device consisting of a probe containing a neutron source and a detector. Several access holes are set up in the orchard and the probe is brought to these sites at regular intervals. When the probe is lowered into the access holes, neutrons from a radioactive source are emitted into the soil profile. When these fast neutrons collide with hydrogen atoms in water, they slow down dramatically and are deflected back to the detector, which responds to slow neutrons only. If the soil is dry, the neutrons don't slow down and are therefore not detected. Readings are taken at various depths to provide an overall view of soil moisture within the profile.

The probe is expensive and is generally used only by consultants to monitor and provide recommendations for watering. Although it is more accurate than tensiometers, its usefulness depends on how regularly readings are taken.

## Capacitance probes

Capacitance probes such as the Enviroscan are continuous moisture monitoring devices based on capacitance sensors. These continuously measure the dielectric constant of the soil and consequently its water content. The sensors are mounted on probes which have slots every 10 cm to accommodate the snap-in sensors. These probes are then placed within vertical PVC access tubes installed semi-permanently in the orchard. The probes are generally left in place for the season and then moved to another tube or site as required. Sensors are positioned on the probes to provide readings at specific depths. Measurements from the sensors are relayed at regular intervals via a cable to a data logger for recording. Data from the logger are downloaded to a computer every few days to show water use and to provide recommendations for watering. Figure 18 is a representation of the Enviroscan capacitance probe.



**Figure 18.** Diagrammatic representation of an Enviroscan probe

For low chill stonefruit, three probes are the minimum recommendation for a block but the number of sites depends on the variability in soil and varieties. The first probe should have sensors at 10, 30, 50 and



Irrigation consultants  
Section 6 page 7

100 cm, the second probe with sensors at 10, 30, 50, 100 and 150 cm, and the third probe with sensors at 10, 20, 30, 50, 70, 100, 150 and 200 cm.

The current cost of a logger, solar panel, 1500 m of cable, four 1.5 m probes, 16 sensors and software is about \$12 000. The equipment can also be hired from some consultants.

As interpretation of the data requires some skill, we recommend that consultants are used to set up the system and provide at least the initial advice.

## Evaporation pan

The evaporation pan technique uses evaporation figures from a pan evaporimeter at a weather station to calculate water requirements at various times of the year. Evaporation figures for your district are available from the Bureau of Meteorology.

The evaporation figures are used in a formula to calculate potential water use. As the formula is complex, Table 18 provides an abbreviated working version to give you some idea of how it works.

**Table 18.** Using readings from an evaporation pan to calculate the number of hours of sprinkler watering per week

Step 1	Obtain from the Bureau of Meteorology a set of mean monthly evaporation figures (Epan) for August to March. Assume there is no irrigation between April and July because trees are dormant	Monthly evaporation figures in mm (Epan)
Step 2	As the evaporation figures are generally based on a US Class A evaporation pan, multiply them by 0.85 to convert the figures to the equivalent of evaporation from a free water surface, to give the adjusted evaporation (ETo)	Epan X 0.85 = adjusted evaporation in mm (ETo)
Step 3	Multiply the figure from Step 2 by a crop factor representing the different growth stages of the tree. The suggested crop factors vary from 0.64 in August to 0.86 in October (for all values, see example following this table)	ETo X crop factor = water use in mm/month. (water use per month in mm)
Step 4	Divide the figure from Step 3 by 4 to calculate the approximate water use/week. This equates roughly to the amount of water required from rain or irrigation. Ignore any rainfall of 5 mm or less	Water use/month ÷ 4 = water use per week in mm
Step 5	Calculate the output of your sprinklers in mm/hour by dividing their output in L/hour by the area of coverage in square metres	Sprinkler output L/hour ÷ coverage in square metres = sprinkler output in mm/hour
Step 6	Divide the figure from Step 4 by the figure from Step 5 to obtain the number of hours of sprinkler watering per week	Water use per week ÷ sprinkler output in mm/hour = sprinkler hours per week

Here is an example using the formula in Table 18 to determine the irrigation schedule for bearing low chill stonefruit trees growing on a palmette system at Alstonville, New South Wales.

Month	Step 1	Step 2	Step 3		Step 4
	Mean monthly evaporation mm (Epan)	Adjusted monthly evaporation mm (ETo)	Crop factor	Water use mm/month	Water use mm/week
August	113	96	0.64	61	15
September	137	116	0.75	87	21
October	158	134	0.86	115	29
November	170	145	0.83	120	30
December	188	160	0.73	117	29
January	180	153	0.73	112	28
February	141	120	0.83	100	25
March	135	115	0.79	91	23

**Step 5: Output of sprinklers in mm/hour.** Sprinklers delivering 40 L/hour and covering 10 sq. m (1.75 m radius) = 4 mm/hour. Sprinklers delivering 40 L/hour and covering 40 sq. m (3.5 m radius) = 1 mm/hour.

**Step 6: Number of hours of sprinkler watering per week.**

Month	Water use mm/week	Hours of watering/week	
		4 mm/hour output	1 mm/hour output
August	15	4	15
September	21	5	21
October	29	7	29
November	30	8	30
December	29	7	29
January	28	7	28
February	25	6	25
March	23	6	23

### Tips for managing with limited water

- Eliminate weed competition near trees. Use herbicides rather than cultivation to avoid damaging surface feeder roots and increasing evaporation losses.
- Keep the interrow grass sward mown close to the ground.
- Mulch trees, particularly during the drier spring months. Mulch to a depth of 15 cm, covering the area under the trees to just beyond the canopy dripline.
- Don't over fertilise with nitrogen as the large leaf area produced increases evaporation losses from the tree.
- Irrigate at night and apply water to the active root area only.





## Pruning and tree size control

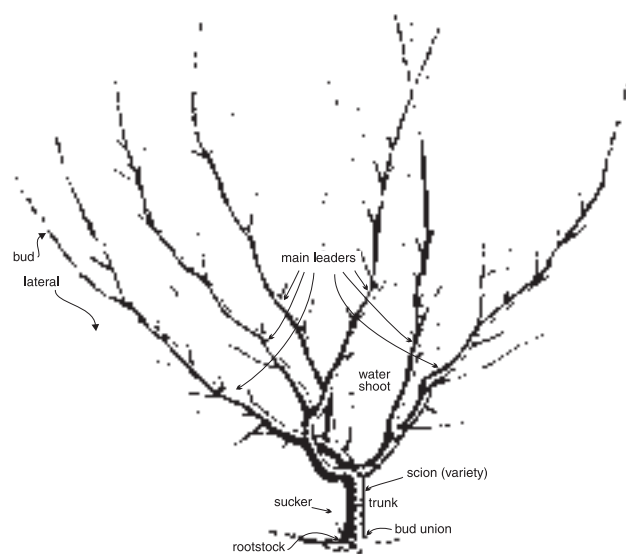
*Pruning is perhaps the most important management operation in low chill stonefruit. Fruit yield and quality are influenced more by pruning than by any other single management operation. Pruning also plays a major role in the positioning of fruit on the tree, a vital issue in the efficiency of spraying, thinning and harvesting operations. Low chill stonefruit are also extremely vigorous growers and controlling tree size is an important related but different issue. Here are the important things you need to know:*

Basic principles of pruning low chill stonefruit .....	56
The two main training systems .....	58
Pruning young trees .....	59
Pruning bearing trees .....	62
Methods of controlling tree size .....	64
Use of Cultar in controlling tree size .....	65

### **Basic principles of pruning low chill stonefruit**

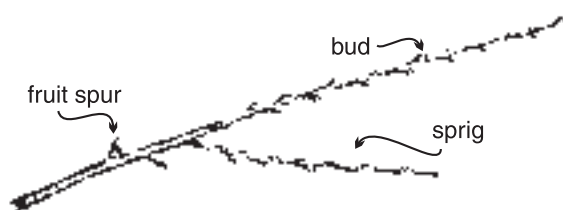
#### **Understanding the terms**

Several terms are used to describe the structure of the stonefruit tree and those parts involved in the pruning process. This can be viewed at three levels, as shown in Figures 19, 20 and 21.

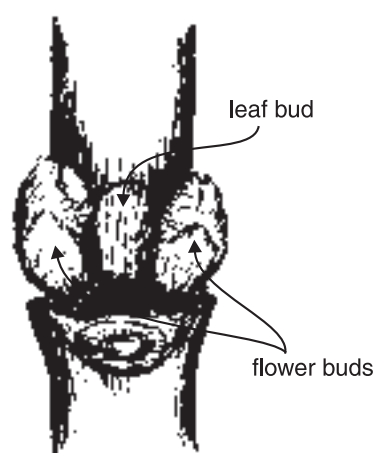


**Figure 19.** The macro view of the low chill stonefruit tree

Note: Leaders are the main shoots or branches that form the permanent framework or scaffold of the tree. Laterals are one-year-old shoots about 200 to 400 mm long that grow from the leaders.



**Figure 20.** Close-up of a fruiting lateral (after *Pruning for the Australian Gardener* by David T Kilpatrick)

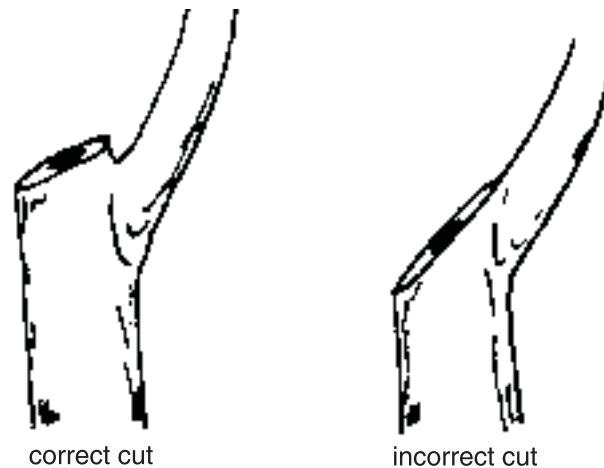


**Figure 21.** Close-up of a multiple bud (after *Pruning for the Australian Gardener* by David T Kilpatrick)

### The main principles

Here are the main principles of pruning bearing trees.

- Terminal buds on a branch and uppermost buds on a tree usually have the greatest vigour.
- Horizontal growth is less vigorous and more fruitful than upright growth.
- Hard pruning usually reduces the potential crop and increases the growth of unwanted watershoots.
- Trees continually pruned hard may have a shorter productive life. You cannot 'dwarf' a tree by hard pruning.
- Untipped leaders will grow and thicken more than tipped leaders.
- For peaches and nectarines, fruit is borne only on laterals produced during the previous season. While fruit can be borne on leader growth, the main crop is carried on laterals. Plums develop short fruiting spurs close to the leader. Spurs can remain fruitful for several years before needing replacement.
- When pruning major limbs, always leave a short stub about 5 mm long (Figure 22).



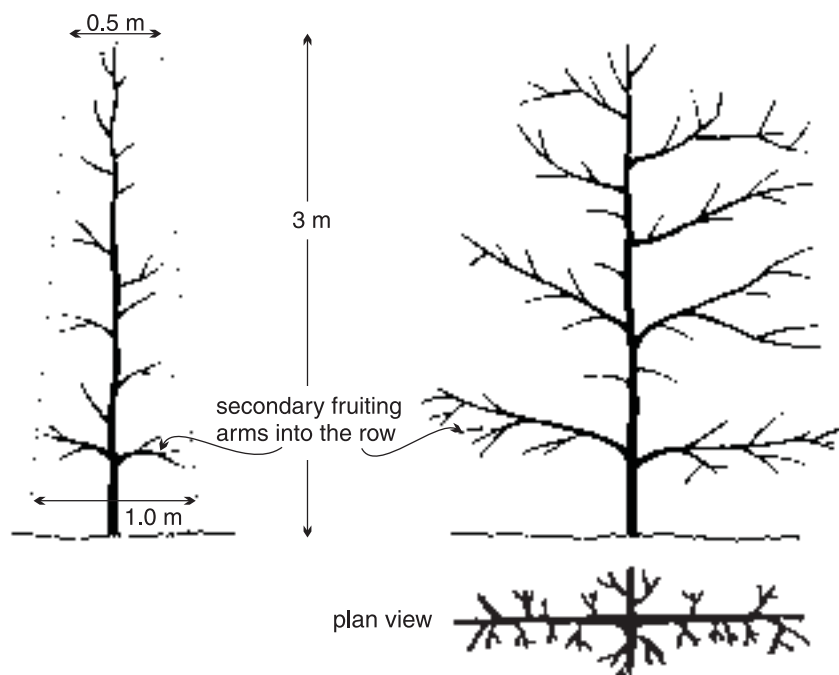
**Figure 22.** How to make a pruning cut

- Seal pruning cuts more than 20 mm in diameter with a proprietary pruning wound dressing, bitumen preparation or white, water-based, anti-mould paint.
- Most laterals carry leaf buds at the base and towards the tip and multiple buds between. Most multiple buds have three buds (one leaf bud with a flower bud on either side). Generally, a flat pointed bud is vegetative and will produce a shoot whereas a full rounded bud will produce a flower (Figure 21).
- The best fruiting wood is laterals about 200 mm long and one to two pencils thick. Short spurs also produce good quality fruit.

### **The two main training systems**

Before we look at the timing and techniques of pruning, it is important to understand that there are two main training systems, each with its own pruning requirements.

- **Open vase.** The open vase is the traditional system where each tree is free-standing and pruned to the shape of a vase or inverted hollow cone. Its main advantage is that trees produce fruit which can be harvested from ground level. Its main disadvantage is that pruning has to be more carefully managed to maintain light penetration into the tree. Figure 19 shows a typical open vase tree.
- **Palmette.** With the palmette system, trees are planted closer and pruned to grow together along the row into a thin continuous hedgerow. For peaches and nectarines, the hedgerow is freestanding. For plums, which produce long pliable laterals, the hedgerow is supported on a trellis. The main advantage of the palmette is that trees are easier to prune and spray. Its main disadvantage is that trees grow taller, making it more difficult to harvest the fruit. Picking platforms or ladders are generally required. A typical palmette tree is shown in Figure 23.



**Figure 23.** End and side views of a palmette tree

Both systems have their place. On flatter land, the palmette system is preferred. On steep land where it is difficult to operate picking platforms safely, the open vase system is preferred.

Whatever system is chosen, here are the ideals for an efficient and productive orchard:

- Rows running north-south where possible. This is more important for palmette than open vase systems.
- Trees at a suitable height to facilitate pruning, thinning and harvesting. For open vase trees, this should be no more than two metres. For palmette trees where picking platforms are used, a maximum tree height of three metres is recommended.
- Canopy no more than one metre deep to facilitate light and spray penetration and easy harvesting.
- Interrow width twice the tree height to prevent shading of the lower canopy.

## Pruning young trees

For both palmette and open vase systems, the task for the first year after planting is to develop the basic structure of the tree so that by the end of the first year, it is about the right size and shape.

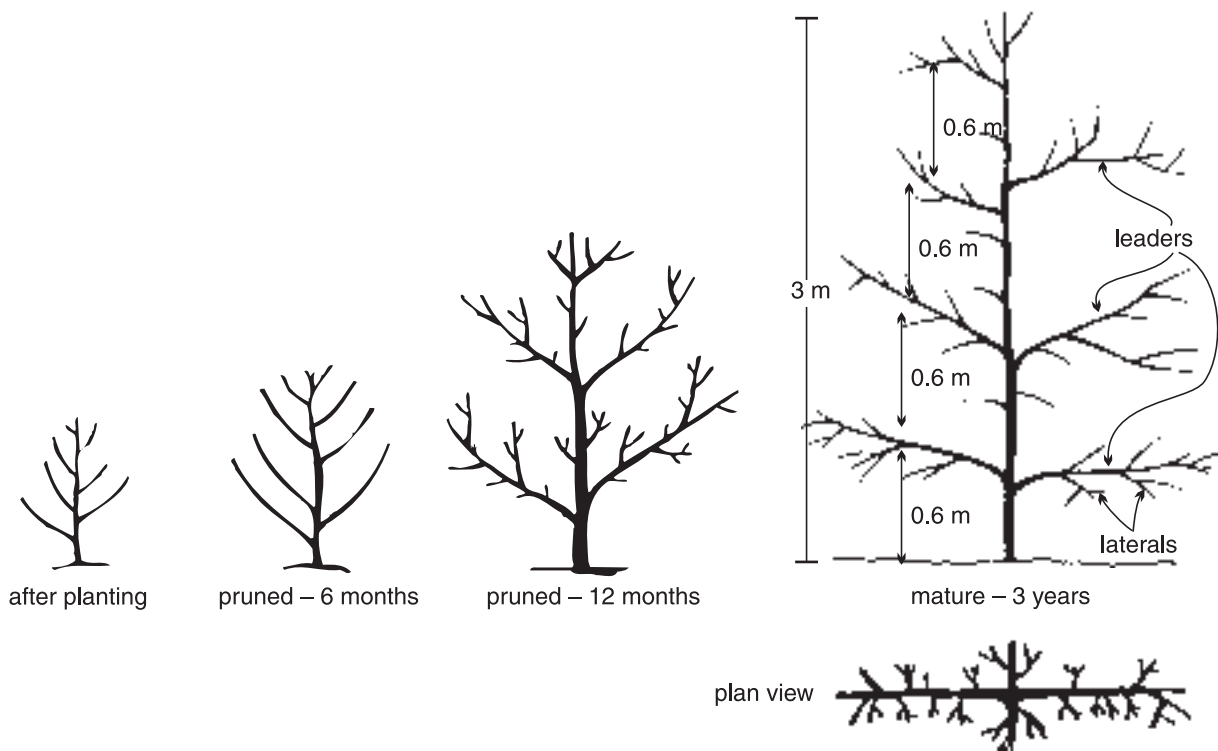
## Palmette training and pruning

The tree is pruned to allow the main leaders to grow only along the row to form a hedgerow about 1 m wide and 2.5 to 3 m tall. Figure 24 shows the beginning and end result. The steps involved are listed after the figure.

more info



Contract pruning services  
Section 6 page 6



**Figure 24.** Training and pruning for trees on a palmette system

### **Step 1. After planting**

If the tree does not have any shoots within 450 mm of the ground, cut off the main stem or central leader at this height. If the tree does have good shoot growth below this point, do not prune the central leader. Instead, remove any shoots growing out into the interrow areas. Leave all shoots growing along the row. Some of these might need to be pruned to an underneath lateral to keep these leaders at about 45° to the trunk.

### **Step 2. About six months after planting**

Trees should be about 1.5 m tall. Remove side shoots and suckers within 300 mm of the ground.

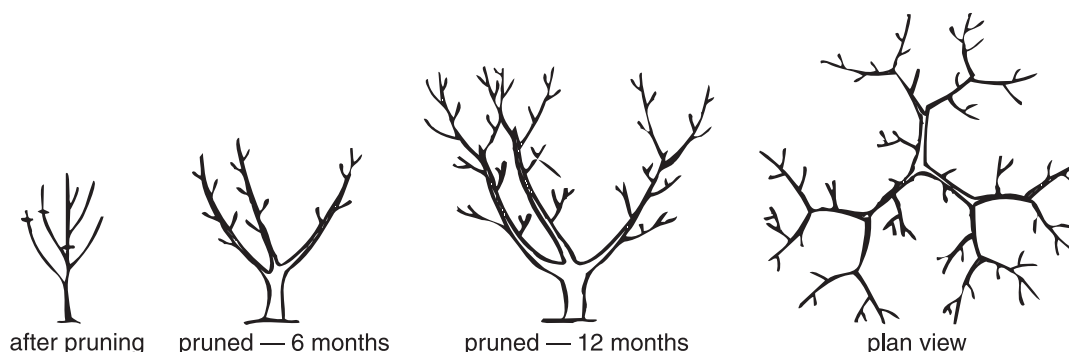
### **Step 3. About 12 months after planting**

The trees should now be large enough to enable you to select the leaders. Selectively remove some shoots (leaders) on either side of the central leader so that remaining leaders are about 0.6 m apart. Spread the laterals away from the leaders to produce wide crotch angles. This will form the permanent framework of the tree. Fruiting laterals will be produced on this framework.

### **Open vase pruning**

The aim of open vase pruning is to get three or four main leaders originating at a point on the trunk about 450 mm from ground level.

These limbs are angled away from the centre of the tree so that the centre is open. Fruit is then borne on laterals growing on these leaders. Figure 25 shows the beginning and end result. The steps involved are listed after the figure.



**Figure 25.** Open vase pruning for the first year

### **Step 1. After planting**

Nursery trees usually carry several small, well spaced shoots around a central stem (often called the central leader). Start pruning as soon as growth starts after planting. Do not prune weak trees until they are well established.

Select three or four, evenly spaced shoots around the central leader and up to about 450 mm from the ground. Remove the central leader just above the highest of the three or four shoots, if this has not already been done. If the shoots on the young plant are too high, prune the plant back to 450 mm high and wait for new shoots to come from below the cut. Do not tip-prune the selected leaders unless one or two are much longer than the others. Prune these back to a strong, outside vegetative bud.

### **Step 2. Up to six months from planting**

Regularly tip leaders to a strong outward vegetative bud to ensure they continue to grow at about a 45° angle.

After about six months, if water and nutrition have been adequate, the trees should be about shoulder height (1.5 m tall). The leaders can now be pruned back to two outward facing vegetative buds at just over a metre high. This stimulates the growth of two growing points from each leader to give six to eight leaders on the tree.

### **Step 3. Twelve months from planting**

The trees should now be just over two metres tall. Start to prune as for bearing trees.



Contract pruning services  
Section 6 page 6

## Pruning bearing trees

Pruning bearing trees has four important purposes:

- It keeps the tree at a manageable size.
- It allows light and spray material to penetrate all parts of the tree.
- It stimulates the production during spring and summer of replacement fruiting wood for the following season.
- It removes excess fruiting wood during winter.

### Pruning strategy

One year after planting the tree should be just over two metres tall. The main aim now is to encourage new fruiting wood (laterals) to grow within the body of the tree.

Prune three times throughout the year (spring, mid-summer and winter). The technique is similar for both palmette and open vase trees.

### Spring pruning

Prune trees lightly a couple of times between stone hardening and harvest, generally from mid-September to mid-October, depending on the variety. These are light prunings only. The aim is to open the canopy to allow light and spray to penetrate easily to the fruit. This improves fruit colour and makes it easier to control pests and diseases. Trees treated with Cultar in the previous autumn may not need this spring pruning.

*At spring pruning*

- Prune out strong growth from tree centres. Leave weak lateral growth on leaders to protect limbs from sunburn.
- Top trees to the framework height (palmette) or reaching height (open vase).
- Remove all watershoots more upright than 45°. Make the cut where the shoots join the leaders.
- Remove suckers.

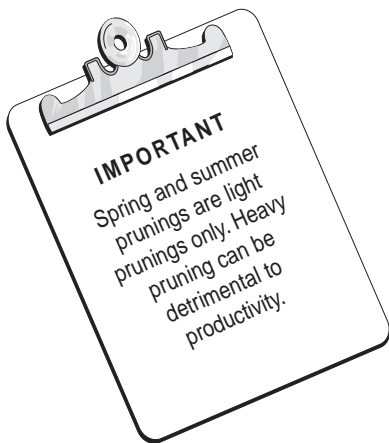
### Summer pruning

Summer-prune two to three weeks after harvest. With early varieties, do this before mid-November to avoid any delays in flowering in the following season.

The aim of summer pruning is to allow light to penetrate the tree. This ensures good flower bud development and induces the growth of new fruiting wood close to the leaders for the next season. **Do not prune heavily.**

*At summer pruning*

- Remove strong water shoots in the tree centre. Leave weak lateral growth to protect limbs from sunburn.



- Top trees to framework height (palmette) or reaching height (open vase).
- Remove some laterals if growth is excessive.
- Do not allow old fruiting wood in the body of the tree to develop into heavy branches. Where potentially fruitful new laterals have been produced along an old lateral, remove wood outside the selected new growth (Figure 26). Where there is no new growth, prune the old spent wood to a stub carrying two or three buds. These generate growth in the following few months and bear fruit the next season.
- Remove old fruit and dead shoots.
- Remove all growth, including suckers, within 500 mm of the ground.



**Figure 26.** How to summer-prune laterals

### **Winter pruning**

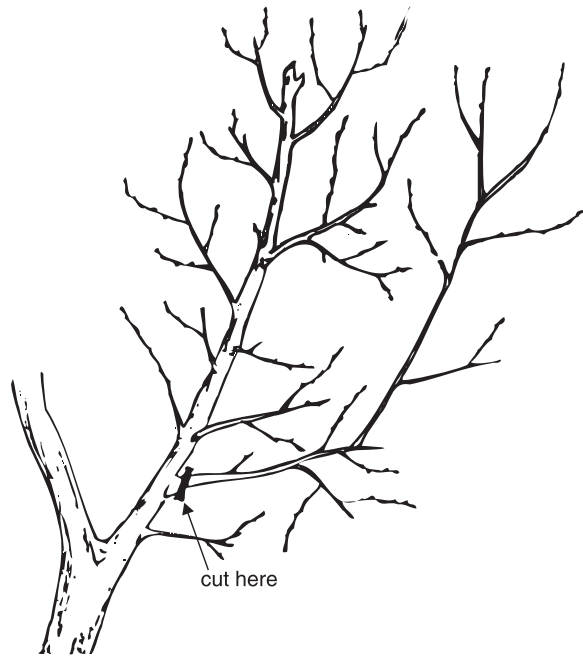
The main purpose of winter pruning is to remove a part of the fruiting wood produced during spring, summer and autumn. This reduces the amount of fruit thinning required later.

Early maturing varieties can be pruned in early June or even late May provided the weather is cold enough not to break dormancy. Otherwise, prune in late June or early July.

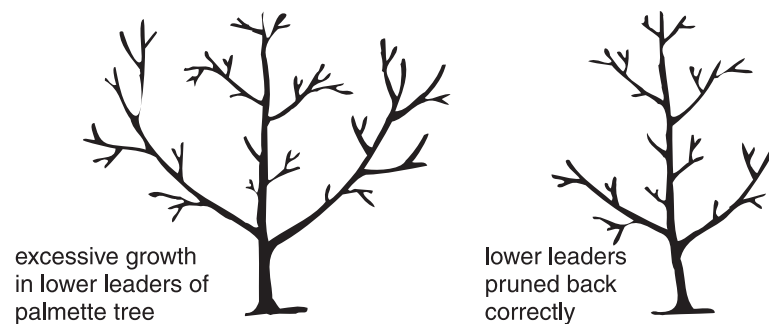
#### *At winter pruning*

- Remove strong secondary laterals that are competing with main leaders (Figure 27).
- Remove strong watershoots not required as replacement wood.
- Top trees to the framework height (palmette) or reaching height (open vase).
- Remove all growth within 500 mm of the ground.
- Remove every second or third lateral, particularly on nectarines which produce many short laterals.
- Tip laterals more than 400 mm long to remove some flower buds by cutting off about one-third of the lateral. More fruitful varieties, in particular nectarines, can be tipped more severely. Short, sturdy spurs should not be cut back.
- In palmette trees, prune the lower leaders back if they are too vigorous (Figure 28).





**Figure 27.** Remove vigorous laterals that compete with the main leaders



**Figure 28.** Pruning lower leaders in palmette trees

## Methods of controlling tree size

A characteristic of low chill stonefruit is excessive vegetative growth. This occurs for several reasons.

- Low chill stonefruit are grown in warmer climates where there is a long potential growth period.
- Buds break out of dormancy earlier than other stonefruit varieties and so have a longer growth period.
- Fruit is carried on the tree for a shorter period and, for a large part of the season, there is no competition for energy reserves.

This excessive growth shades the fruiting wood, reducing fruit colour and quality, as well as reducing the potential crop for the next season. It also makes it harder to thin the fruit and spray for pests and diseases. The trees are also more difficult to prune and manage.

Several strategies have been tried to control this excessive vigour.

- **Heavy pruning.** This is generally ineffective as heavily pruned trees react by producing more vigorous shoots and strong sucker growth. Wood rots are also more prevalent in the large exposed pruning cuts.
- **Restricting irrigation.** This is generally impracticable as it runs the risk of also reducing fruit size and quality if it is not perfectly timed.
- **Cincturing (ringbarking) of the main limbs.** This is very labour intensive and also increases the incidence of undesirable fruit problems such as split stone and skin cracking. Cincturing also provides sites for potential disease infection.
- **Use of the growth retardant — paclobutrazol (Cultar).** This is the best and most practicable technique yet developed. It works by inhibiting the production of gibberellic acid — a growth hormone responsible for elongation of shoots.

### **Use of Cultar in controlling tree size**

---

The use of Cultar has some advantages and disadvantages. Here are the advantages.

- The amount of summer pruning is reduced because there is less growth of strong vigorous leaders.
- It offers a potential increase in fruit yield, mainly by increasing fruit size. This is largely because Cultar promotes the production of short, thick fruiting laterals.
- It makes harvesting easier.
- Fruit is better coloured by exposure to higher light intensities and potentially freer from pests and diseases through better spray penetration into the canopy.
- Flowering is advanced by up to two to four weeks and fruit maturity by up to five days, providing the opportunity for higher early season prices.

Here are the disadvantages.

- As the number of flower buds and fruit set is increased, there is a need for more fruit thinning.
- Treated trees are more susceptible to nutrient deficiencies and infestation by spider mites, and require much more careful management.
- Trees that are under stress, waterlogged or affected by nematodes may be killed by the treatment.
- The response varies, depending on soil type, tree condition, temperature and rainfall. It takes a couple of years of testing to calculate an appropriate dose for an individual orchard.
- The chemical has a residual effect in the soil. Replanting within three years of treatment may result in poor growth in new trees.



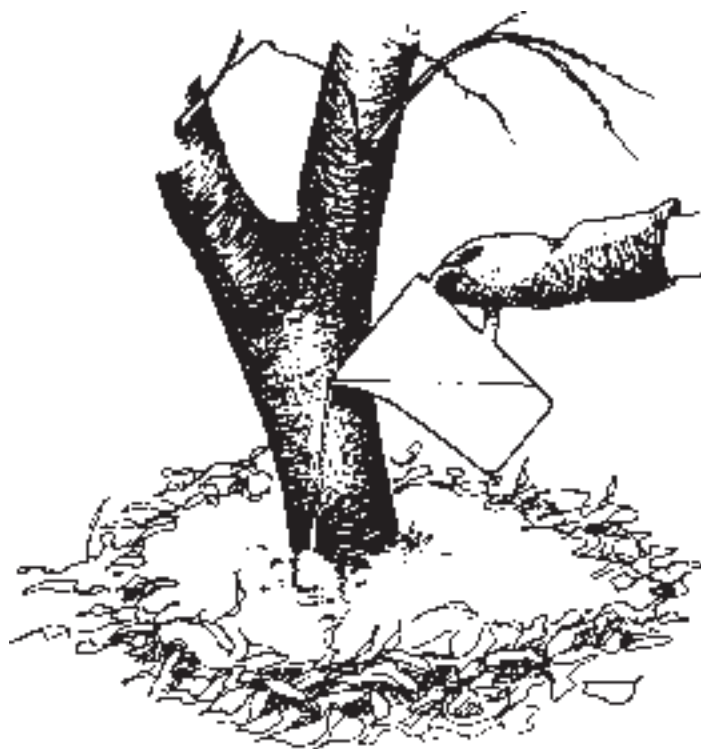
### Our rules for the use of Cultar

- Wait until you have had a year or two of experience in managing normal trees before experimenting with Cultar.
- Wait until trees have reached their desired size (two years after planting) before treatment.
- Only contemplate its use where you are prepared to try the product on a few trees first and where you are prepared to actually measure its effects.
- The product label suggests two alternative application times — early autumn (mid-March, about four weeks before leaf fall), and spring (between 14 days before budburst and full bloom). Of the two, we prefer the spring application for low chill stonefruit. Research continues into more appropriate application times.
- Select three healthy trees per block or variety and apply a different rate within the label rate of 2 to 4 L/ha to each tree. Rates at the higher end are suggested for heavy clay soils and rates at the lower end for light sandy soils. The rate per tree is calculated by dividing the rate per hectare by the number of trees per hectare (Table 19). Do not exceed the label rate under any circumstances. Apply to healthy vigorous trees only. The application of different trial rates is necessary to determine the most appropriate rate for your soil type and tree condition.

**Table 19.** Example rates for use of Cultar

Tree type	Rate (L/ha)	Rate (mL/tree)
Open vase (5.5 x 4.6 m = 395 trees/ha)	4	10
	3	7.5
	2	5
Palmette (4.0 x 2.75 m = 909 trees/ha)	4	4.5
	3	3.3
	2	2.25

- Apply the required volume in one litre of water as a collar drench. Pour the mixture on to the soil right up against the collar of the tree and all the way around the trunk (Figure 29).



**Figure 29.** Application of Cultar as a collar drench

- If the soil is dry at application, irrigate immediately after the drench has been applied. Remember that trickle irrigation systems will generally not assist uptake as the water is normally applied well away from the trunk application site of the Cultar. Rain is generally required in these circumstances to achieve uptake.
- Measure the effects on the trial trees throughout the subsequent spring and summer. Measure that there is:
  1. no excessive weakening of the tree's fruiting wood
  2. an annual shoot extension of 40 to 60 cm
  3. sufficient renewal wood produced for the next season's crop.
- Only treat larger numbers of trees when you have confirmed no adverse effects of the treatment.
- Don't treat old blocks where you envisage replanting new trees within three years.
- After the initial application, reduce the rate for the next and subsequent years. For example, if you applied 4 L/ha on the first application, use 3 L/ha for the next and subsequent applications.
- Reduce nitrogen rates to compensate for the reduced growth.





## Pest and disease management

*Managing insect pests and diseases is a most difficult aspect of growing low chill stonefruit. There are several serious pests and diseases and some will inevitably develop during the life of the crop. Many have the potential to destroy fruit yield and quality. Here are the important things you need to know:*

The traditional approach to pest management .....	68
The modern approach — IPM .....	69
The managed spraying alternative .....	70
Monitoring pests .....	70
Pest and disease management program .....	74
Precautions when selecting chemicals .....	77
Disease forecasting service (NSW only) .....	78

### **The traditional approach to pest management**

The traditional approach to pest control was to apply routine calendar sprays of chemicals. This approach had several problems.

- It was a waste of money if the pests were absent.
- Even when pests were present, it disregarded the fact that trees can tolerate small numbers of pests without significantly affecting yield and quality. In these cases, the cost of spraying is much greater than the benefit gained by controlling the pest.
- It increased the risk of chemical damage to the fruit.
- It was costly, with up to 20 chemical sprays being applied each season.
- It relied heavily on new chemicals being developed to replace those for which insects develop resistance. This contradicts the modern reality where fewer new chemicals are being discovered and developed.
- It was severe on beneficial insects and mites and sometimes resulted in outbreaks of pests which were well controlled naturally.
- It exposed the farm family and farm employees to a range of toxic chemicals.
- It increased the amount of chemical residue in both the fruit and the environment.

## The modern approach — IPM

The modern approach to insect pest control involves less reliance on chemicals by using all or several complementary control measures in an integrated program known as Integrated Pest Management (IPM). There are several key elements of IPM:

- using cultural control measures such as crop hygiene, crop rotation;
- using biological control measures such as naturally occurring or introduced parasites, predators and pathogens (known as beneficials) of the insect pests;
- using chemicals only where necessary. Preference is given to chemicals which are compatible with the beneficial insects and 'softer' on the environment;
- carefully applying chemicals with well calibrated spray equipment to avoid crop damage, excess residues and off-site pollution;
- checking the crop regularly to determine when pests are present and taking action only when pests are present and at damaging levels. This process of checking the crop for pests is called monitoring.

Monitoring works by first determining pest action levels — the pest populations at which damage is considered worthy of attention. The action level can be thought of as the point at which the damage is roughly equivalent to the cost of control. Pest populations are then regularly monitored and control measures applied only when pest populations approach or reach this action level. Monitoring then continues to allow pest populations to be managed at or below this action level. As well as the pests, the beneficial insects and mites which naturally attack the pests are also monitored. This is because in some cases, they alone will be sufficient to keep the pest populations in check.

Monitoring requires skill in observing and identifying pests and beneficials. This requires considerable training and experience. For this reason, we recommend use of professional pest monitoring services.

An IPM system which uses all of the above elements is well established in low chill stonefruit. In some situations, pests such spider mites can be well controlled without chemicals. However, IPM is not without risks. It works best in the following situations:

- dry inland areas where pest pressure is lower;
- where pest consultants or skilled monitors are available to do the monitoring and provide on-the-spot technical advice;
- where you as a grower are dedicated to IPM ideals and prepared to accept the odd failure inherent in a biological system, trading that off against the advantages offered.

For more detail on IPM including detailed monitoring and full details of pests and beneficials, read the book *Protect your stonefruit*.



Note that diseases are difficult to monitor in the same way as insect pests. A disease is microscopic and in most cases, by the time you see symptoms, it is well established and difficult to control. We therefore rely on preventive sprays to control most disease problems. Monitoring is still useful for detecting some diseases such as brown rot and for evaluating how well your rust disease prevention program is working.

### **The managed spraying alternative**

If you are unable to employ the complete IPM system, you can still take advantage of the principal benefit offered — reduced chemical spraying — by using just some of the elements. This system uses the following strategy:

- monitoring pest populations broadly as outlined previously;
- using chemicals alone when action levels are reached;
- giving preference to chemicals that are ‘softer’ on naturally occurring beneficials so that they can exercise maximum benefit;
- carefully applying chemicals with well calibrated spray equipment so that maximum impact is achieved with each spray.

This strategy is called managed spraying and is the minimalist position we recommend for pest control in low chill stonefruit.

### **Monitoring pests**

Whether you are using IPM or managed spraying, pest monitoring is the basic common requirement. As mentioned earlier, we recommend you use professional pest monitoring services. These consultants visit the orchard about every seven to ten days during the main part of the season to monitor pest populations. After each visit, the pest consultant provides a report on pest status, and required sprays. The cost of using a pest consultant varies, depending on planting density, pest and disease status of the orchard and so on.

If you wish to do the monitoring yourself, we suggest you first get some training from a pest consultant. Here are the main requirements for monitoring.

#### **Materials**

- x10 hand lens, magnifying glass or small microscope
- notebook, prepared monitoring charts and pen
- plastic bags or small bottles and marking pen for samples
- sharp pocket knife
- roll of coloured plastic tape

#### **Other**

- commitment and the time to do regular monitoring at least every week to ten days



Pest monitoring services  
Section 6 page 6

- good eyesight
- a good knowledge of the pests and beneficial insects and mites
- common sense.

Monitoring is not intrinsically difficult. It is just a process of systematic observation and recording.

### How many trees to monitor

Define your orchard as blocks. A block is trees of the same variety and about the same age. Each block should be monitored separately. If your entire orchard consists of trees of the same variety, then treat it as one block.

For most pests, closely examine at least 20 trees in every hectare in each block. If you have less than one hectare in any block, then check ten trees in that block. Ten trees is the minimum number to check. Planting density does not affect the number of trees you need to monitor.

### How often to monitor

While monitoring is necessary throughout the whole season, the frequency varies. Here are the minimum frequencies for the four main periods during the year:

- **Dormancy.** Check the orchard once only. It is best to do this before winter pruning. If scales are detected, mark the trees with coloured plastic tape so they can be sprayed at budswell.
- **Flowering.** Do two checks — once when trees are just beginning to flower and again when most trees are in full flower.
- **Fruiting period (petal fall to harvest).** Check trees at least once per week.
- **After harvest to leaf fall.** Check trees once every two weeks for two-spotted mite and once per month for other pests.

### Monitoring procedure

Prepare some monitoring charts to record the results of your pest monitoring.

Each time you monitor, select trees randomly but from different parts of the block. While moving between these selected trees, keep alert and visually scan intervening trees. Collect two leaves from each of 20 trees per hectare per block for mite checks. You can check these leaves with your hand lens straight away, or put them in a bag inside an esky for examination back in the shed or office. If you collect samples, mark the sample with the block number and date.

more info



Monitoring chart  
This section page 72





**PEST MONITORING CHART**

Tree no	Pest or disease						
	QFF						
1							
2							
3							
4							
5							
6							
7							
8							
9							
10							
11							
12							
13							
14							
15							
16							
17							
18							
19							
20							
TOTAL							
%							

KEY:	
QFF — Qld fruit fly	OFM — Oriental fruit moth
OFB — Orange fruit borer	BC — Bacterial canker
YPM — Yellow peach moth	BS — Bacterial spot
RB — Rutherglen bug	BR — Brown rot
S — Scale	R — Rust

Insert the appropriate column headings. Record the % of leaves, fruit or twigs infested for each tree for caterpillars, bugs and fruit fly. For scale, record if the tree is infested.

Tree no	Mites	
	SM	
1		
2		
3		
4		
5		
6		
7		
8		
9		
10		
11		
12		
13		
14		
15		
16		
17		
18		
19		
20		
TOTAL		
%		

KEY:	
SM — Spider mites or eggs	
Pred — Predatory mites	

Record the number of leaves with at least one mite or mite egg.

Insert the appropriate column headings. Record the % of leaves, fruit or twigs infested for each tree for caterpillars, bugs and fruit fly. For scale, record if the tree is infested. Record the number of leaves with at least one mite or mite egg.

After each monitoring, transfer the results from your monitoring charts to an orchard record which will cover the full season. This will form a permanent record of the trend for each pest and beneficial insect over the season, and will be very valuable once data have been recorded over several years.

**Monitoring calendar**

Table 20 shows a monitoring calendar with appropriate action levels for the main pests. Note that pest levels below the action level are not considered damaging enough to warrant the cost of treatment. Pest levels above the action level mean that some action should be taken immediately to prevent further pest build-up. A pest treatment program combining appropriate actions from the monitoring with essential disease sprays is shown in Table 21.

**Table 20.** Pest monitoring calendar

Time	Pest or disease	Frequency	Procedure	Action level
Dormancy	Scale insects	Once	Peach white scale is easily seen but San Jose scale, because it is small and grey, is difficult to see. In most cases it is easier to look initially for signs of damage rather than for the insect. Look for rough, cracked or dimpled bark or dead twigs. Suspect trees should be checked thoroughly for live scale. Mark infested trees with coloured tape so they can be sprayed and rechecked in September. Be sure to check trees downwind of those found to be infested.	If present
	Brown rot Bacterial spot Bacterial canker	Once	Check for fruit mummies, twig infection and cankers.	If present
Early blossoming	Thrips	Twice, once at one quarter bloom, once at full bloom	By the time you see thrip damage, it is too late. You need to detect thrips before they do any damage. To check for thrips, place a note-pad or small container under a lateral carrying flowers and shake it vigorously. If thrips are present, they can be observed on your hand or in the container. Use a x10 lens to confirm they are thrips. Pay particular attention to nectarines as they are generally more susceptible to damage.	10% of trees infested
Late blossoming	Blossom blight (brown rot)	Once	Check flowers for blossom blight.	If present
Fruiting	Scales	Once in September	Check those trees that were sprayed during dormancy. Examine the scale with a pin and x10 lens or microscope to see if they are dead. Gently turn several scales over to see if the insect underneath is dead and dry. Live scale are soft-bodied and yellow. Also examine adjacent trees, particularly those downwind, for live scale.	If live scale present
	Queensland fruit fly	Once every week	There are several ways of monitoring for fruit fly. Because it is such a serious pest, we recommend a combination of monitoring techniques: <ul style="list-style-type: none"> <li>• Hang fruit fly traps in late August (about one trap in the centre of each large block). Empty after counting every 3 to 4 days.</li> <li>• Check visually for adult flies on fruit or leaves.</li> <li>• From early September onwards, check for stung fruit (small dried blobs of clear gum on the fruit surface). If in doubt, cut through the skin under the blobs and see if small eggs are present. (A hand lens is useful for this).</li> </ul>	Either 20 flies per trap per 3 or 4 days or stung fruit or several flies on fruit
	Spider mite	Once every week	Collect two leaves from each of 20 of the randomly selected trees per hectare for examination. This is 40 leaves in total. Examine the undersides of the leaves for both spider mites and predatory mites. Also look for pale sparse foliage which may indicate mite 'hot-spots'.	20% of leaves infested with one mite or mite egg (release predators). 60% of leaves infested with one mite or mite egg and a predatory mite on less than 40% of leaves (spray).

Time	Pest or disease	Frequency	Procedure	Action level
Fruiting ...cont.	Rutherglen bug Red shouldered leaf beetle Heliothis Yellow peach moth Light brown apple moth Orange fruit borer Fruit piercing moth Brown rot Rust Aphids	Once every week	Check for signs of these pests. Look for: <ul style="list-style-type: none"> <li>clusters of Rutherglen bugs or red shouldered leaf beetles on foliage, fruit or weeds</li> <li>holes or chew marks on fruit (Heliothis, yellow peach moth, light brown apple moth, orange fruit borer)</li> <li>weeping pin holes on fruit (fruit piercing moth)</li> <li>webbed leaf shelters at stem end of fruit (orange fruit borer)</li> <li>rolled and webbed leaves near fruit (light brown apple moth)</li> <li>shoots infested with aphids</li> <li>fruit with early signs of brown rot</li> <li>rust spots on undersides of leaves.</li> </ul> For the fruit pests, examine five randomly selected fruit per tree.	5% or more of fruit with fresh injury 5% of fruit with bugs 10% of shoots infested with aphids Large swarms of bugs or beetles Brown rot or rust present
After harvest to leaf fall	Spider mite	Once every two weeks	Collect two leaves from each of 20 of the randomly selected trees per hectare for examination. This is 40 leaves in total. Examine the undersides of the leaves for both spider mites and predatory mites. Also look for pale sparse foliage which may indicate mite 'hot-spots'.	20% of leaves infested with one mite or mite egg (release predators). 60% of leaves infested with one mite or mite egg and a predatory mite on less than 40% of leaves (spray).
	Oriental fruit moth Yellow peach moth	Once every month	Examine five randomly selected shoots on each of 20 trees per hectare in each block.	10% of shoots infested
	Scale Rust Light brown apple moth	Once every month	Check for signs of these pests. Look for: <ul style="list-style-type: none"> <li>rolled and webbed leaves (light brown apple moth)</li> <li>cracked rough bark or dead twigs (scale)</li> <li>rust spots on undersides of leaves.</li> </ul>	Live scale present 10% of shoots infested with light brown apple moth Rust present

## Pest and disease management program

A pest and disease management program combining appropriate actions from the monitoring with essential disease sprays is shown in Table 21.

**Table 21.** Pest and disease management program (See the 'Problem solver handy guide' for all trade names, rates, withholding periods and registration status of chemicals for the different stonefruits)

Timing	Essential sprays			Optional sprays, depending on monitoring (action level reached)		
	Problem	Preferred chemical or other treatment	Comments	Problem	Preferred chemical or other treatment	Comments
Early bud movement (July)	Leaf curl and shot hole	chlorothalonil (not registered on nectarines – use copper or dithianon)	Apply 1 spray at budswell (2 sprays a week apart if budswell is variable).	Bacterial spot and canker	copper oxychloride	Apply one spray at budbreak if twig cankers present.
Flowering (August)				Blossom blight	chlorothalonil <b>Alternative chemicals:</b> benomyl captan (NSW only) carbendazim iprodione procymidone propiconazole triforine	Spray at 10% blossom, full bloom, and petal fall. Where benomyl or carbendazim are used, apply once at full bloom. Alternate use of different fungicides to avoid disease resistance developing. See 'Precautions' after this table.
				Thrips	endosulfan tau-fluvalinate (nectarines only)	Spray late in the evening.
				Bacterial spot (plums only)	phosphorous acid (Qld only)	Spray at late petal fall where bacterial spot is a problem.
Fruiting (September–November/December)	Rust and shot hole	chlorothalonil mancozeb dithianon	Apply every 3 weeks. Chlorothalonil and dithianon are the safest to use as they are less toxic to predatory mites, and less likely to cause spray burn. Do not mix mancozeb with fenthion as spray burn may result.	San José scale	chlorpyrifos	Check trees in September for signs of live scale. If detected, spray at high volume to thoroughly wet trunk and branches. Re-check six weeks later and re-spray if live scale still present.
				Fruit fly	<b>Bait spray:</b> chlorpyrifos plus yeast autolysate <b>Cover spray:</b> fenthion trichlorfon	Apply 50 mL of the mixture to the lower leaves of each tree every 7 days. Reapply after rain. Stop bait spraying 4 weeks before harvest and switch to cover sprays. Spray every 7 days until harvest. Spray the whole tree.

Table 21. ...cont.

Timing	Essential sprays			Optional sprays, depending on monitoring (action level reached)		
	Problem	Preferred chemical or other treatment	Comments	Problem	Preferred chemical or other treatment	Comments
Fruiting ... cont.				Rutherglen bug	endosulfan trichlorfon (NSW only)	
				Mites	Release predatory mites <b>Chemicals:</b> propargite fenbutatin-oxide tebufenpyrad (peaches only)	When mites are present on about 20% of the leaves, release predatory mites. If mites are present on more than about 60% of the leaves, first spray and then resume monitoring.
				Brown rot	As for blossom blight above or dithianon	Spray at 3 to 4 weeks and again 1 to 2 weeks before harvest. Dithianon and chlorothalonil are preferred where predatory mites are being used.
				Lightbrown apple moth	azinphos-methyl fenthion (NSW only) <i>Bacillus thuringiensis</i>	
				Oriental fruit moth	fenthion azinphos-methyl	
				Red shouldered leaf beetle	carbaryl (Qld only) methomyl (NSW only)	
				Bacterial spot (plums only)	phosphorous acid (Qld only)	Spray at 3 to 4 weekly intervals where bacterial spot is a problem. Note 28 day withholding period.
After harvest to leaf fall (November/December – May)	Rust and shot hole	chlorothalonil mancozeb dithianon	Apply every 3 weeks. Use dithianon if rust is severe. Dithianon and chlorothalonil are the safest to use as they are less toxic to predatory mites, and less likely to cause spray burn. Do not mix mancozeb with fenthion as spray burn may result.	Mites	Release predatory mites <b>Chemicals:</b> propargite fenbutatin-oxide tebufenpyrad (peaches only)	When mites are present on about 20% of the leaves, release predatory mites up to the end of February. If mites are present on more than about 60% of the leaves up to and beyond the end of February, spray.
				Oriental fruit moth	fenthion azinphos-methyl	

Table 21. ...cont.

Timing	Essential sprays			Optional sprays, depending on monitoring (action level reached)		
	Problem	Preferred chemical or other treatment	Comments	Problem	Preferred chemical or other treatment	Comments
Dormancy (May–June)	Brown rot	Prune off infected twigs and mummified fruit. Burn or bury.	Essential to lessen the risk of brown rot in subsequent flowers and fruit.	Scales	petroleum oil	Spray infested trees. It is very important to use the correct rate. Mark infested trees with tape and re-check in September. Do not apply 2 full strength oil sprays in the same year as trees may die or suffer severe dieback.
	Bacterial spot	Copper oxychloride	Spray trees once at about 30 to 50% leaf fall to protect the leaf scars from infection.			

Note: NSW growers should use this table as a guide only. For specific recommendations, use *An orchard protection guide for deciduous fruits in NSW* (available July 1998).

## Precautions when selecting chemicals

The development of pest and disease resistance to some chemicals is becoming a major problem. Resistance occurs where individual, naturally-occurring resistant strains of a pest or disease build up through the continual use of one type of highly selective chemical. In low chill stonefruit, particular problems exist with spider mites and brown rot disease.

### Spider mites

To avoid problems with chemical-resistant mites, use predatory mites instead of chemicals. However, if chemicals need to be used, use different miticides in rotation. Use each miticide only once per season and don't apply them unnecessarily. Use monitoring to determine when spraying action is really required.

### Brown rot

Chemicals registered for the control of brown rot can be classified into five groups as shown in Table 22.

**Table 22.** Groupings of brown rot chemicals

Chemical type	Chemical (trade name/s)
Benzimidazole group	benomyl (Benlate) carbendazim (Bavistin, Spin)
Dicarboximide group	iprodione (Rovral) procymidone (Sumisclex)
Dithiocarbamate group	mancozeb (Mancozeb, Manzate, Dithane, Penncozeb) thiram (Thiram) ziram (Ziram, Fulasin, Cyram, Bryzam, Ziragranz) zineb (Zineb)
Ergosterol inhibitor group (EI'-s)	propiconazole (Tilt, Bumper) triforine (Saprol)
Miscellaneous group	chlorothalonil (Bravo, Rover, Fung-O-Nil, chlorothalonil, Crotop) captan (Captan) dicloran (Diclosan) dithianon (Delan)

The strategy for minimising the build-up of resistance involves using chemicals from more than one group. In particular, use the EI group for no more than three sprays per season. To minimise exposure of the disease to the chemicals, pay careful attention to orchard hygiene by removing diseased fruit and old fruit mummies throughout the year.

### **Disease forecasting service (NSW only)**

NSW Agriculture provides a special disease forecasting service for low chill stonefruit growers in the Northern Rivers area of New South Wales. Wetness and temperature are measured, infection periods for rust and brown rot are identified and weekly disease warnings issued through local media. The service is relevant to growers from Alstonville to Macksville. The issue of a disease warning means that a spray should be applied immediately.



Service contacts  
Section 6 page 12



## Netting

*Low chill stonefruit is extremely susceptible to significant damage from birds and flying foxes. There are two main reasons for this — most growing areas are located close to the forest habitats of birds and flying foxes, and the early spring fruit production often coincides with weather conditions that decrease the availability of native nectar food sources for these animals. Consequently, most growers face significant losses from time to time.*

*Over the years, growers have used many different methods of dealing with this problem. These have included shooting, various scaring devices, odour emitters, overhead electric wires and acoustic repellent equipment. However, we believe that none of these provide the same level of protection as total orchard netting. This involves erecting a structure of poles, tensioned wires or cables covered by net over the top of the orchard trees. Here are the things you need to know about orchard netting:*

The pros and cons of netting .....	79
Planning .....	80
Construction procedure .....	84

### **The pros and cons of netting**

There are several advantages of netting orchards.

- Netting provides absolute protection against losses, provided the structure is well maintained. The value of netting is only now being clearly identified. For example, research in lychees has shown that over several years, the average loss of crop in an unprotected orchard, compared to a netted orchard, is about 60% but varies from 5 to 100%. Experts believe that the average figure for low chill stonefruit, although less, is still about 30%.
- Netting provides peace of mind, not available with other protection systems. Once the netting is constructed, growers know that there is no opportunity left open for damage. Compared with other systems, there is also no physical or mental effort required to maintain protection during the fruiting season.
- The netting structure can be made multi-purpose. Provided a suitable mesh size is chosen, the net can provide protection against birds, flying foxes, fruit piercing moth and hail. If secure at ground level, it can also provide protection against possums, wallabies and hares.



- Netting is an environmentally-friendly and socially-responsible approach to the problem. It avoids using techniques which some people may find offensive.

There are few problems with netting apart from its high cost, the risk of storm damage and the need for maintenance. Cost is the major hurdle. Whole orchard netting costs from \$12 000 to \$30 000 per hectare depending on materials (poles, net, fittings) and the extent of the grower's labour input. A figure of \$12 000 to \$16 000 per hectare is considered an average outlay.

It has been calculated that to achieve a reasonable return on investment of 30% at 10 years, the average fruit loss would need to be about 15% per year (bat net) to 17.5% (bird/semi-hail net) for a small orchard of 1.36 ha, and 10% per year (bat net) to 12.5% (bird/semi-hail net) for a larger orchard of 4.28 ha. If netting costs \$15 000 per hectare and losses exceeded 30% per year, then savings from lost fruit would recoup costs within three seasons.

## Planning

The netting structure referred to in the remainder of this section is a flat canopy consisting of a net canopy held in place by a grid of wires or steel cables supported and tensioned at the perimeter by poles and anchors. Other structures are available. Consult a netting contractor or consultant. There are nine important issues in planning a netting structure.

## Professional assistance

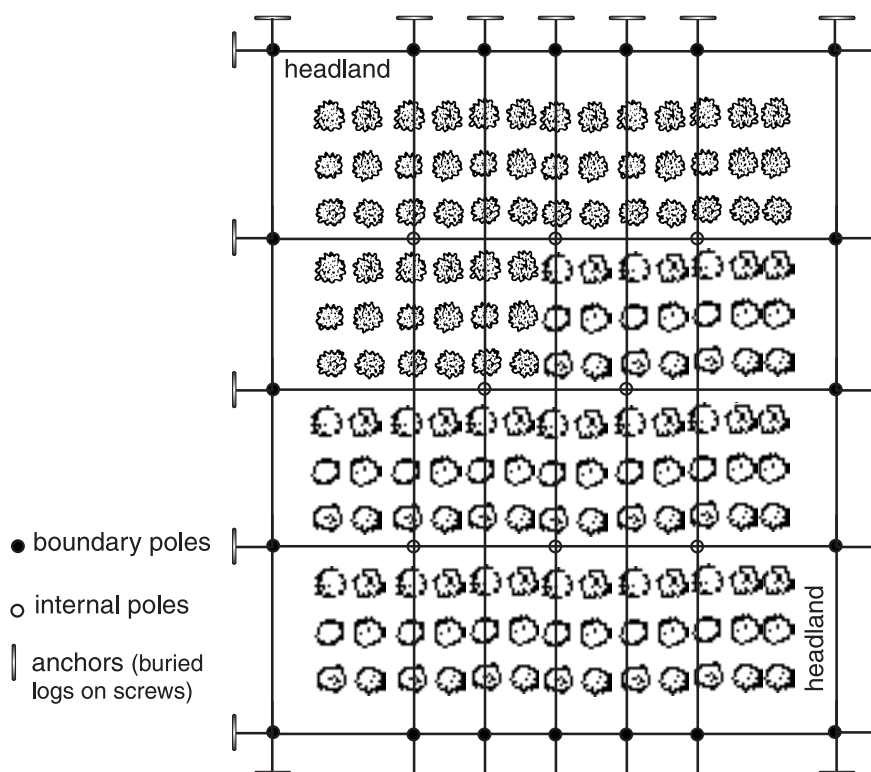
The netting structure needs to be designed to withstand wind loads, the weight of the net when wet, and possibly the extra weight of hail. Seek professional advice from a structural engineer or a netting contractor. Netting contractors provide a complete design and construction service.

## Pole size and quality

As the structure will be subject to storms and perhaps cyclones, use good quality poles. Poles that are CCA-treated to H5 standard are preferred as these have a life of 40 years. Galvanised steel poles are also suitable. The general practice is to imbed perimeter poles and anchors in the ground and use lighter internal poles which are often not imbedded. Internal poles are generally placed under every second grid wire junction (Figure 30). Where the soil is soft, use anti-sink pads to prevent the poles sinking into the soil. Boundary poles should have a small end diameter (SED) of 200 mm and internal poles a SED of 150 mm.



Netting consultants & contractors  
Section 6 page 9



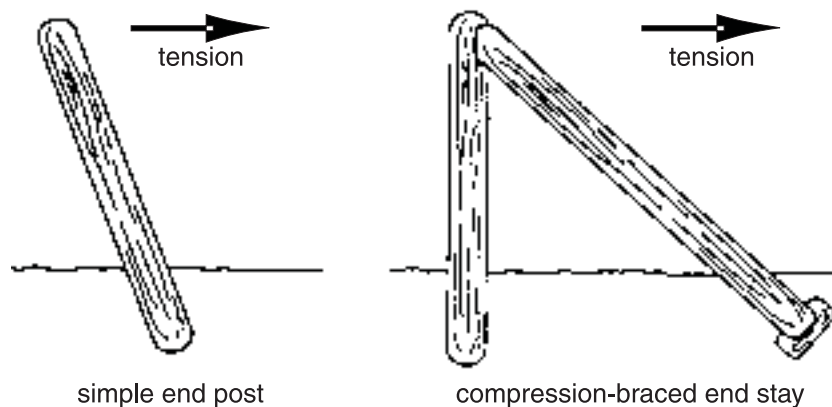
**Figure 30.** Overall plan of a typical netting structure (adapted from Guidelines for netting orchards and backyard fruit trees, courtesy John Gough)

### Anchor type and position

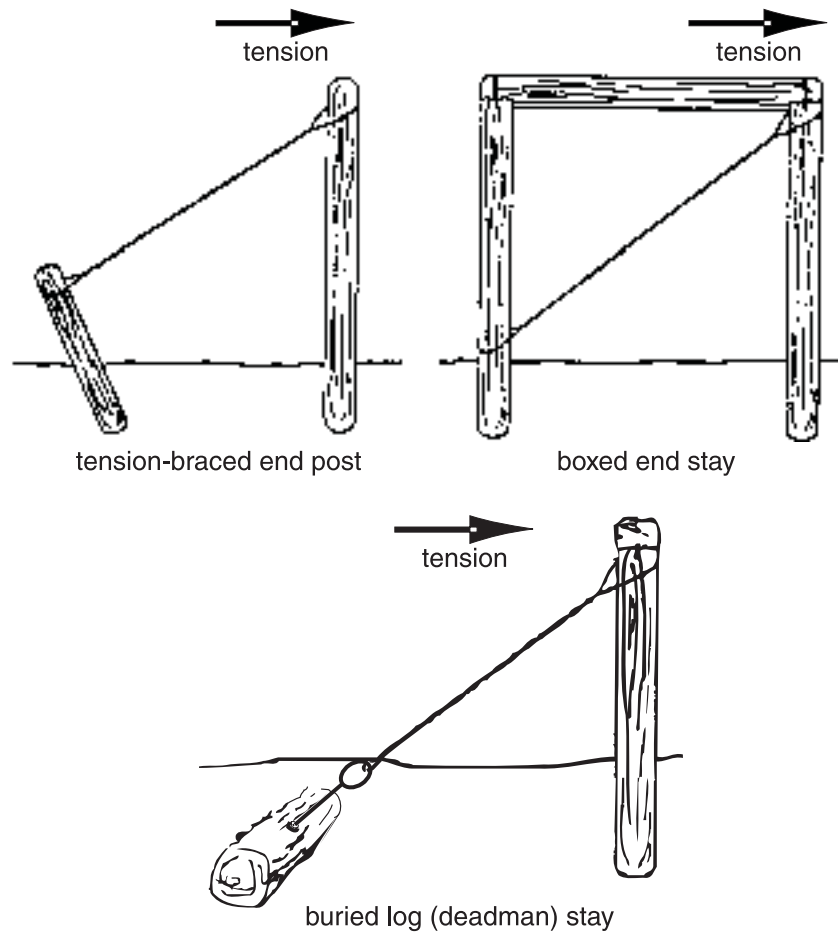
There are five possible types of anchors:

- simple end post
- compression-braced end stay
- tension-braced end post
- boxed end stay
- buried log or deadman.

These are illustrated in Figure 31. Although the boxed end stay is the best, it is rarely used because of cost. The most common and practicable are the tension-braced end post and the buried log or deadman.

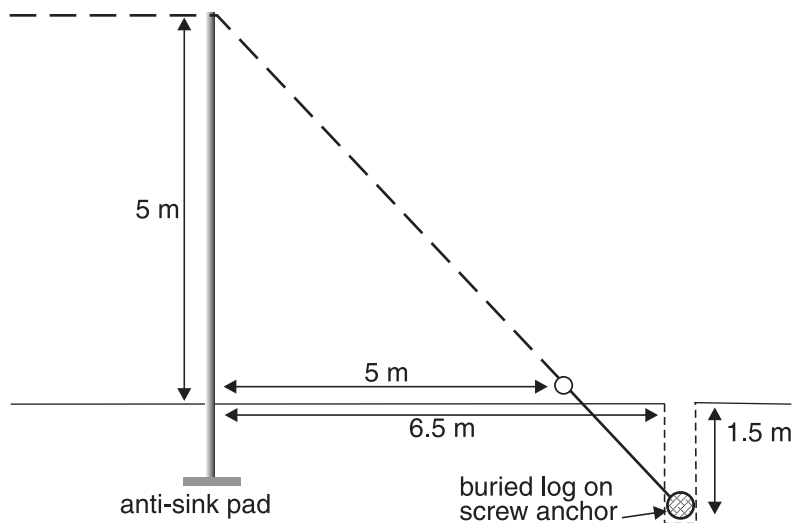


**Figure 31.** Types of anchors ...continued on next page



**Figure 31.** Types of anchors ...cont.

The buried log or deadman anchor should have an SED of 225 mm with the tensioning wire attached by a screw anchor. Position the anchors at a maximum of 45° from the pole top. An example of this positioning is shown in Figure 32.



**Figure 32.** Positioning of anchors (adapted from Guidelines for netting orchards and backyard fruit trees, courtesy John Gough)

### Wire or cable

Use only high tensile wire. The common wire used is high tensile 3.5 mm or 10-gauge galvanised wire. Steel 7.5 mm cable is used occasionally to increase span widths and lengths. Guy wires that run from perimeter posts to anchors should be a double strand of the wire used in the grid. The wire needs to be properly tensioned to hold the structure firmly in place and prevent wear on the net. Use a tension gauge to achieve appropriate tensions more accurately.

### Orientation of wire/cable and net

Where possible, run the net in the same direction as the rows.

### Headland room

Plan for at least nine metres between the outer edge of the stonefruit trees and the boundary/windbreak trees/buildings etc. This allows plenty of room for machinery access within the enclosure as well as for the netting structure itself. If the structure is too close to boundaries, heavier cables and deeper anchors will be necessary.

### Height of structure

This depends on intended tree height, clearance required and the amount of sag in the net. Where cable is used, net sag is minimised but a sag of one metre per 170 m is acceptable. Common structure heights are 3.5 to 4.5 m for open vase trees and 5 m for palmette trees.

### Net characteristics

There are several features to consider.

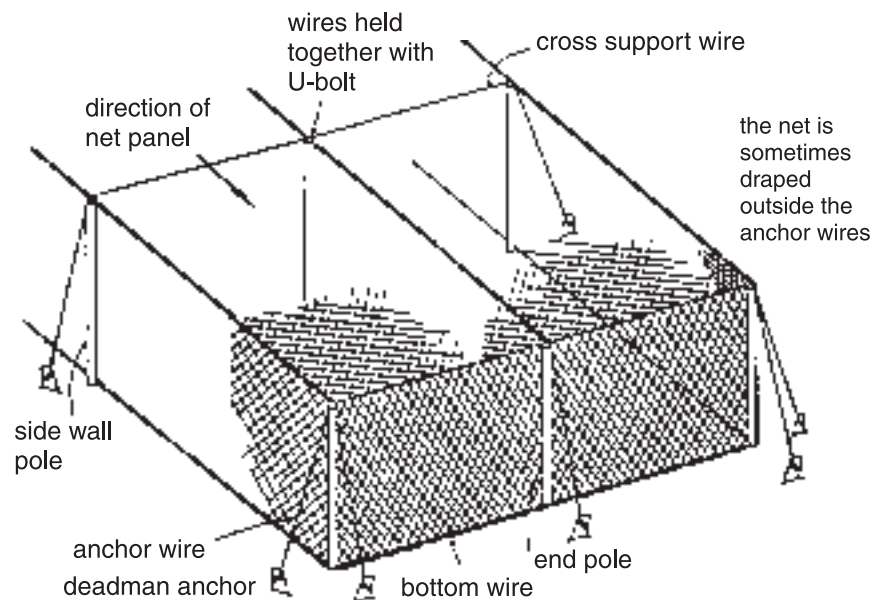
- **Mesh size.** The smaller the mesh size, the more expensive the net and the stronger the structure needed to support it. For protection against flying foxes and larger birds such as lorikeets, mesh size should be 45 mm or less. For protection against smaller birds such as silvereyes, mesh size should be 20 mm or less. For protection against fruit piercing moth, mesh size should be 10 to 15 mm or less. Remember that mesh size is measured with the net erected at the recommended tension.
- **Net type.** There are three types of nets — extruded, knitted and knotted. The best are knitted nets made from woven monofilament strands without knots. When tensioned, these nets assume a triangular mesh shape. Some nets have an extra monofilament strand across the mesh (called crossover mesh) for extra protection. The most common nets are made from high density polyethylene (HDPE) and these have good durability. Nets should last ten years. Use nets with woven selvedged edges for extra strength and so the net material won't unravel. The edges also reduce abrasion damage and allow wire to be threaded through for easy attachment to the wire grid.

- **Net colour.** Black nets use carbon black as a UV stabiliser and have the best durability. White nets are cheaper but have a life expectancy of about two-thirds of black nets.
- **Net width.** For practical purposes, net panel widths should coincide with tree row widths or multiples of these. Consequently, panels are usually 10 to 15 m wide but can be specially manufactured to any width up to 50 m. With flat canopy designs, panel widths greater than ten metres require a support wire down the centre of the panel to reduce sag. The higher tensions possible with cables will eliminate this need.

## Doors

Plan the position of doors carefully for efficient access. Doors generally consist of a curtain drop with a pipe weight at the bottom.

An illustration of a typical netting structure is shown in Figure 33.



**Figure 33.** A typical netting structure

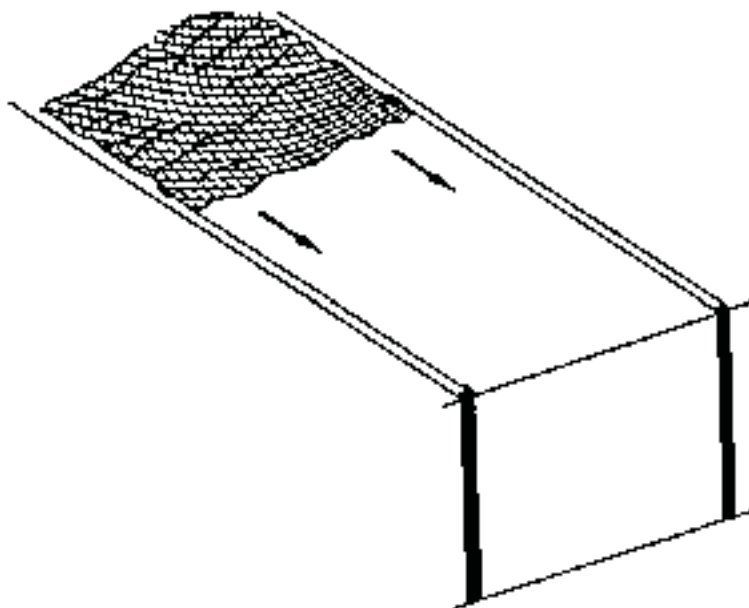
## Construction procedure

1. Erect poles and anchors. Imbed corner and edge poles 1 to 1.5 m in the ground and anchors 1.5 m. In sandy soils, poles may need anti-sink pads in the bottom of the holes.
2. Erect wire grid and tension to firm only.
3. Thread a net wire through the net selvaging. The net does not have to be expanded to do this. In many instances, the net manufacturer will have threaded a polytube through the net selvaging. This makes the job of threading the net wire very easy.
4. Place the bunched panels of net up onto the wire grid.
5. Attach the net wire to the perimeter wires at both ends but do not

### HINT

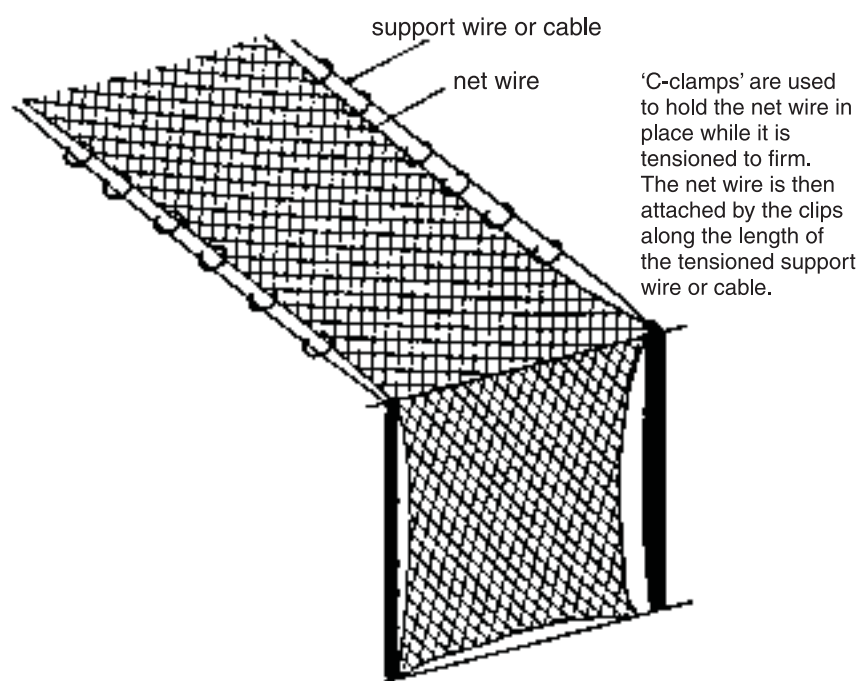
A special video on net construction canopies is available for viewing at some DPI and NSW Agriculture offices and libraries

tension them. Expand the net out to its full length (Figure 34). The mesh should be diamond shaped.



**Figure 34.** Erecting nets

6. Use C-hooks or some other type of fastener to hold the support wires of the grid close to the net wires (Figure 35).



**Figure 35.** Securing net with C-hooks

7. Tension the net wires to firm only.
8. Clip net wires permanently to the support wires. Use Duralink clips or galvanised wool bale fasteners.

9. Put side-wall net panels in place.
10. Tension net and support wires to their correct tension. Use a tension gauge. High tensile 10-gauge wire (3.5 mm) needs to be tensioned to 2 KN (450 lb).
11. Lace net to right angle grid wires for extra strength. This transfers some of the wind load along the right angle grid wires to the side anchors, thus reducing the load on the anchors on the windward edge.



## Fruit thinning

Most low chill stonefruit varieties set many more fruit than can be matured to a marketable size. Under normal conditions, a mature peach tree will set around 2 000 fruit and a mature nectarine or plum around 3 500 fruit. Research shows that the tree has capacity to grow only 300 to 350 of these to a size acceptable to the market. As premium prices are paid for large fruit, the need for thinning is clear. Here are the important things you need to know:

The background to thinning .....	87
Thinning technique .....	88

### The background to thinning

As well as the problem of reduced fruit size, the setting of large numbers of fruit also leads to poor skin colour and increased potential for insect and disease damage.

Careful winter pruning will remove some of the potential crop but blossoms and fruit will need thinning during flowering and after fruit set. Although thinning reduces the potential yield of the crop, the benefits of better fruit size, colour and quality out-weigh any yield loss. For this reason, it is better to over-thin than under-thin.

The aim is to reduce the natural set to about the figures shown in Table 23. This is roughly equivalent to about one fruit every 15 cm (a hand width) along each fruiting lateral.

**Table 23.** Suggested final fruit load per tree after thinning

Training system	Peach	Nectarine/Plum
Open vase	300	360
Palmette	150	200

Another advantage of thinning is that it enables better positioning of fruit on the tree. For example, fruit can be selected closer to the scaffold limbs and more evenly distributed throughout the tree for better light interception and easier harvesting.

### Time of thinning

There are three options for the timing of thinning.

- **Blossom thinning only.** The best time for blossom thinning is at about full bloom plus 15 days. Thinning at blossoming is quick and





easy and provides the greatest potential increase in fruit size. However, it is risky as you are not able to compensate later if weather conditions adversely affect the remaining fruit. It is also difficult to achieve an adequate level of thinning with just the one thinning at blossoming. As a result, blossom thinning alone is not entirely practicable and should only be considered where there is no risk of frost or other adverse weather after thinning.

- **Fruitlet thinning only.** The best time for fruitlet thinning is just after fruit set. Its advantage is that it is again a 'one pass' operation but it can be time-consuming and obviously reduces the full potential of increase in fruit size available from earlier thinning. However, it is the only option available for growers in frost prone areas where late frosts can damage blossoms and fruit.
- **A two-stage combination of blossom thinning and fruitlet thinning.** This is the preferred option for all areas where there is no risk of late frosts. Although it involves two operations and may seem labour intensive, two-stage thinning provides the best overall balance of quantity and quality of the final crop. Normal two-stage thinning involves blossom thinning to broadly get fruit numbers close to the final goal and fruitlet thinning to adjust the final crop to the required fruit numbers. Weather conditions are monitored during blossoming and blossom thinning minimised in seasons when the following conditions occur:
  - a) an extended period of three or four days of heavy rain at full bloom (Reason: reduced fruit set from poor pollination),
  - b) night time temperatures of about 18° to 20°C during blossoming (Reason: reduced fruit set from poor pollination),
  - c) insufficient chilling (Reason: blossom emergence may be tardy and erratic).

Remember the general rules are:

- Thin as early as your conditions allow. The earlier you thin, the greater the increase in size of remaining fruit.
- Thinning should be fully completed well before seed hardening begins (about 40 to 50 days after full bloom). In coastal areas, this is about early September. Fruit can be 1 to 2 cm in diameter by this time. Seed hardening is indicated when the seed becomes 'crunchy'. This is best judged by cutting fruit in half lengthways and feeling the stone with the tip of a knife.

### Thinning technique

Thinning chemicals that are sprayed onto the tree are used to thin fruit in other stonefruit and deciduous fruit varieties. However, there are no thinning chemicals yet suitable for low chill stonefruit. All thinning must be done by hand.



---

Contract thinning  
services  
Section 6 page 6

---

### **Blossom thinning at budbreak**

The easiest way to thin the blossom at budbreak is simply to run the fingers up one side of each lateral, knocking off the flowers as you go.

### **Fruit thinning after fruit set**

Fruit thinning after fruit set involves working along each lateral, selectively removing fruit until the required number remain. Before starting, shake the branches vigorously to first dislodge any fruit that are ready to fall.



## Manipulating flowering and fruiting

The normal cycle of low chill stonefruit is to flower in late July and mature the fruit from mid to late October. Because stonefruit is a seasonal crop and high prices are paid for early new season fruit, there is a temptation to try to achieve earlier flowering and fruit maturity. While this is technically possible, it has some serious limitations. It should be attempted only by those in appropriate climatic zones and then only in an experimental sense. Here are the important things you need to know:

The options for manipulating flowering and fruiting .....	90
Early flowering .....	91
Trial program for planned early flowering .....	92
Trial techniques for advancing fruit maturity .....	93

### **The options for manipulating flowering and fruiting**

Techniques for advancing flowering and fruit maturity can be divided into four main categories.

#### **Advancing flowering by avoiding the chilling requirement**

This means trees are not allowed to enter a rest period and the need for chilling is avoided. Flowering is then induced by bending the shoots and either chemically or hand defoliating them. This system is most relevant to tropical areas where insufficient chilling is available for most varieties. It is not used commercially in Australia.

#### **Advancing flowering by reducing the chilling requirement of the variety**

This is relevant to areas where sufficient chilling is obtained but the grower wants to advance flowering by reducing the amount of chilling required to break dormancy. This is the most relevant of the flower advancement techniques for Australian conditions and is discussed further under *Trial program for planned early flowering*. It involves pre-conditioning the flower buds in summer and early autumn by water management and the use of growth retardants, followed by the application of rest breaking chemicals during dormancy. It is most

applicable to varieties with very low chilling requirements of less than 200 chilling units.

### **Advancing flowering by enhancing chilling**

The only practical way to enhance chilling is evaporative cooling from overhead misting, making this technique limited in its usefulness.

### **Advancing maturity by increasing heat accumulation and nutrient availability for fruit development**

This involves use of techniques such as girdling and plastic cloching. As these have practical limitations, they are still largely experimental. Some preliminary information on these techniques is provided under *Trial techniques for advancing fruit maturity*.

## **Early flowering**

---

There is a big difference between accidental early flowering and planned early flowering.

### **Accidental early flowering**

Accidental early flowering in late autumn and early winter is not unusual. It may occur for the following reasons.

- Stress in late summer from poor nutrition (mainly low nitrogen levels), lack of water or heavy pruning may cause trees to go dormant early. The warm conditions then induce the trees into a spring-type flowering.
- Early defoliation in autumn from leaf diseases or heavy spider mite infestation exposes the newly-initiated buds, and the warm conditions then induce a spring-type flowering.
- Heavy rain in May sometimes induces an early flowering. The mechanism is thought to be a cooling of the buds and the leaching of flowering inhibitors out of the flowers.

Accidental flowering should be avoided as in most cases, it produces poor quality fruit and uses up valuable energy reserves. It also results from poor management and so is in no way controlled. For this reason, it is important to keep trees in good growing condition during late summer and early autumn. This means carefully managing fertiliser and water, controlling pest and disease problems and avoiding hard pruning.

### **Planned early flowering**

Deliberate induction of early flowering in say May or June is very different to accidental flowering in three important ways:

- Planned early flowering is only feasible where the weather in June to August after the early flowering is warm enough for leaf and fruit growth. The warm weather is necessary to maintain active sap flow

more info



Managing bearing trees  
Section 3 page 22

and root growth. This practice is only feasible in areas where the winters are warm enough and where frosts do not occur after the anticipated flowering date. Even here, we recommend you try it only on limited numbers of trees.

- Planned early flowering requires a detailed and complex management program involving the deliberate manipulation of a range of inputs including water, fertiliser, pruning, defoliation and growth retardant. This is in direct contrast to accidental flowering which generally occurs because of low levels of management.
- Planned early flowering is most feasible with early varieties at the low chill end of the range (less than 200 chill units). Even with these varieties, the practice may require chilling to be artificially enhanced in some years. The only technique for achieving this is evaporative cooling from overhead misting or sprinkling. However, where late frosts are not a problem, the technique may be tried with varieties with higher chill units.

### **Trial program for planned early flowering**

Here is a suggested trial program only. There is no guarantee that it will work. We suggest it as a starting point, with growers adjusting the operations for each orchard.



late November	Apply Cultar to reduce tree vigour.
January	Gradually reduce irrigation to slow vigour but do not over-stress the trees.
late March	Increase irrigation and fertilise trees.
mid to late April	Apply two or three sprays, one week apart, of 5% potassium nitrate to defoliate trees. If this does not defoliate trees, spray with 5% zinc sulphate or copper oxychloride in the first week of May.
late May/early June	Trees flower (provided chilling is sufficient). Prune lightly, removing unnecessary laterals. Thin blossom to one fruit per lateral.
mid June	If trees do not flower because of insufficient chilling, spray again with 5% potassium nitrate. Do not spray once flowering has started as this will thin flowers and fruitlets.
June – August	Maintain irrigation and fertiliser to get good leaf and fruit growth. Use reflective mulch under trees to help fruit colouring and development.
late September – early October	Harvest.

## **Trial techniques for advancing fruit maturity**

In addition to the trial program which may induce early flowering and subsequent early maturity, there are several other techniques under trial for advancing fruit maturity. The results are inconclusive and so the techniques are not recommended. Some growers, however, may wish to experiment with these on small numbers of trees. Trees need an active root system for these techniques to be effective. This means that soil temperatures must be high enough to activate root growth. Otherwise, fruit is being grown on stored tree reserves only, and this may result in smaller fruit size.

### **Girdling**

Girdling trees has been shown to advance fruit maturity by three to five days and concentrate it in a slightly shorter period. It also appears to increase fruit size and fruit sugar levels. The downside is that girdling increases the incidence of split stone and skin cracking. It also provides potential wound sites for the entry of disease.

It is only of value for the very early varieties such as Flordaprince peach and SunWright nectarine (both needing 150 hours chilling).

The technique involves completely girdling the main scaffold limbs with a girdling knife. A 2 to 3 mm wide girdle appears appropriate. The wood should not be cut – just remove the bark.

Trees should be girdled about 7 to 10 days before stone hardening (or about 40 days after full bloom). Girdle only healthy trees more than four years old. Do not girdle trees under stress or those carrying less than a full crop.

### **Plastic cloches**

Although expensive, temporary plastic cloches over the trees have been used to increase temperatures during the fruit development period and thus enhance fruit maturity. The objective is to raise the night temperatures above 15°C. If used, the cloches must be ventilated during the day to stop temperatures rising above 32°C, otherwise any benefit will be lost.

### **Dormancy breaking chemicals**

Chemicals that artificially break dormancy and thereby promote earlier flowering and fruit maturity are used in other crops such as grapes. These are currently under trial in low chill stonefruit and are not yet registered or recommended.



## Marketing and quality management

*Marketing is one of the vital issues in growing low chill stonefruit successfully but regrettably one which is often seen to be secondary to growing the crop. However, marketing is probably the issue that will make the biggest difference to your success as a grower. This section covers the main things you need to know.*

The need for better marketing .....	94
Know what the market wants .....	95
Deliver the product that the market wants .....	95
Quality management systems .....	98
New and improved market opportunities .....	99
Export .....	100

### **The need for better marketing**

As a marketing commodity, low chill stonefruit has several things going for it. It is well established, known and popular with consumers and, because current consumption is significantly lower than that for citrus, apples, pears, bananas and melons, there is considerable room for market expansion.

Growers will not be able to cash in on these advantages however, unless the product is properly marketed. There are three important issues.

- The potential problem of oversupply on the domestic market cannot be avoided as the volume of production increases, making the market tighter and more competitive. This is evident by the 10% fall in average domestic prices for stonefruit between 1992 and 1996. To maintain a profitable margin, growers will need to be more active in searching out new market opportunities both in Australia and overseas, and strongly promoting the product to consumers.
- The changing face of wholesale fruit marketing has seen supermarkets beginning to dominate the management and distribution of the commodity. This will move the focus away from the central wholesale markets to more direct buying or brokering arrangements with growers and marketing groups. This will require significant structural change for growers in the marketing of their produce.

- A growing focus on food safety and quality is developing to better service modern consumer needs. Consumers are becoming more demanding and are better at communicating their needs to marketeers. Growers need to be in touch with these needs. The old adage – ‘grow for the market, not market what you grow’ — is a good concept to work under. Growers must gear their production and marketing system to deliver a product that meets those market needs. Quality management is considered the only way of consistently ensuring your product meets these market needs.

## **Know what the market wants**

---

There are two important sources of knowledge and information on market wants.

- Market research studies. These are generally conducted by industry and research organisations and are published in special reports. Grower organisations, the Australian Horticultural Corporation (AHC) and the Horticultural Research and Development Corporation (HRDC) are sources of this information.
- Marketeers who are in close contact with buyers and consumers. For the domestic market, specialist stonefruit wholesale agents in the major metropolitan markets are an invaluable source of detailed market knowledge. Market authorities in each of the major markets can provide some advice on specialist stonefruit wholesalers. For the export market, stonefruit exporters are an equivalent source of expert market knowledge.




---

Market information  
sources  
Section 6 page 10

---

Consumers are generally looking for fruit with the following characteristics:

- large size — counts of 23 or larger preferred. There is a better acceptance of small nectarines than small peaches.
- high colour
- good firmness
- good shelf life — seven days preferred
- clean appearance and good presentation
- good flavour
- yellow flesh preferred

Remember that quality is invariably more important than price as a factor in consumer purchase.

## **Deliver the product that the market wants**

---

Having established what the market wants, the next step is to gear your production and marketing system to deliver a product with those specifications. The only way of ensuring this is to have a quality management system at the farm level. The easiest way to do this is to



become part of one of the marketing groups or cooperatives that have quality management systems. If you are not part of a group quality system, however, you can implement your own quality management system.

### Understanding quality management

Quality is a term used to describe the fitness for purpose of a product. It implies a predictable degree of uniformity and dependability. Quality management is the control exercised over all of the activities that influence product quality.

In the past, the suitability of the product for its intended market was determined by what is called 'end point inspection' — inspection at the market level. This system has several important flaws.

- It is expensive to reject product at this late point in its cycle.
- It is difficult to predict product performance during the rest of the marketing process when its past history is unknown.
- It is often driven more by tradition than by real market needs.

Modern quality management aims to build quality right through the production and marketing process so that there is little or no need for rejections late in the process. This system also provides consumers with documented evidence that the product they are buying will meet their needs. As such, quality management is a marketing tool to achieve better prices and repeat sales, as well as a productivity improvement tool to identify problem areas, prevent mistakes and reduce wastage. It also helps growers access markets with quarantine and other barriers to normal entry and promotes greater trust and cooperation throughout the marketing chain.

There are five core principles of quality management.

- The customer defines quality, not the grower.
- Decisions are based on facts, not feelings.
- Problems are identified at the earliest possible point, not at the end point.
- Quality management has to be planned, organised and managed — it does not happen by itself.
- Everyone in the business, including the workers, is responsible for quality management, not just managers.

### Implementing a quality management system

Here is the broad process you need to follow to implement a quality management system.

- Learn about quality management. Read as much as you can about the subject and attend training courses where these are available. The Australian Horticultural Corporation has some excellent information and training resources on the subject.





of fruit aside in the cold room so you can check its marketing characteristics in a few days time when your consignment will be in the hands of the retailer and consumer. Ask your wholesale agent to provide feedback on the quality of your fruit.

Remember that it is not easy to put a quality management system together. You will need commitment, good planning, staff involvement, and simple and effective procedures including well defined and objective quality standards.

### **Quality management systems**

Quality management systems formalise the knowledge, experience and methods developed previously into a simple documented process. Several quality management systems exist and they vary in complexity and purpose. Here are the main ones relevant to horticulture.

- **ISO 9002.** This is an internationally recognised system and is the one on which most others are based. It consists of 20 elements covering all aspects of producing products and servicing customers. It is expensive to establish, costing from \$5 000 to \$20 000 to implement and about \$3 000 to \$5 000 in annual auditing and registration fees.
- **HACCP 9000 (Hazard Analysis and Critical Control Point).** This is a relatively new food industry system combining elements of risk management and quality management. It involves a process of identifying risks or hazards and applying specific control measures, primarily to prevent food from being unsafe to eat. It adds about 20% to the cost of the ISO 9002.
- **SQF 2000 (Safe Quality Food).** This system was developed by Agriculture Western Australia for small businesses in the food industry. The system consists of six elements incorporating aspects of ISO 9002 and includes the HACCP system. It is recognised in Australia, but not internationally at this stage. It costs upwards of about \$2 500 to implement and about \$500 in annual auditing costs.
- **AHQ (Australian Horticultural Quality).** This is an accredited training package but not an auditable quality management system. It is generally used as a foundation for growers to upgrade to SQF 2000 or ISO 9002 at a later date.
- **Woolworths Vendor Quality Management Standard.** This is an HACCP-based food safety and quality requirement for Woolworths suppliers who do not have SQF 2000 or ISO 9002. The company is first targeting its major direct suppliers but intends to eventually demand it as a minimum standard for all suppliers.
- **AQIS Certification Assurance (CA).** This scheme was established by AQIS as an alternative to end point inspection. It is a voluntary arrangement between AQIS and exporting businesses to replace the inspection function with set procedures and regular audits.

- **Interstate Certification Assurance (ICA).** This system was developed by state departments of agriculture as an alternative to inspection procedures for fruit fly disinfestation before interstate shipment. It consists of set procedures and annual audits.

### **New and improved market opportunities**

Once you have developed a system to provide a product that meets the market need, it is important that you do not rest on your laurels. To maintain a competitive advantage, you must maintain an active involvement in researching new and improved market opportunities. Here are some of the things you can do.

- Consider getting together with other growers to develop group cooperative marketing under a common quality management system. The longer lines of consistent quality produced under this system gives you access to possible market segments unavailable to most individual growers.
- Groups should consider using a professional marketing coordinator, particularly for export markets. A coordinator maintains close contact with all of the markets throughout Australia and overseas. The product can then be directed to each market based on the coordinator's intimate knowledge of how much it can handle before it is oversupplied and prices fall. The coordinator may also undertake market development and promotion on behalf of the group. When the coordinator handles all of the marketing decisions and problems, growers can concentrate on what they do best — growing quality fruit.
- Consider any value adding opportunities. Consumers now are better educated, more health conscious, and are demanding more convenience in their foods.
- Support any market research proposed by your industry as it will greatly benefit your future marketing opportunities.
- Support any promotional activities implemented by your industry, including those aimed at improving fruit handling in the wholesale and retail markets. These will increase sales and potential returns. Consumers generally have insufficient knowledge about availability, storage and use, and promotion helps to build their confidence in the product. Stonefruit is regarded as a luxury purchase that has to compete with other similar fruit for the consumer's dollar.
- Look for specialist low chill stonefruit wholesalers who present a positive enthusiastic impression, particularly when things are tough. Wholesalers who specialise in seven or eight products normally develop more expertise in the product and should do a better marketing job than generalists. Keep in regular contact with your wholesaler or marketer. Get regular feedback on consignments — a fax or computer and modem are invaluable for this.

## Export

Exporting of stonefruit is well established, although this accounts for only a small percentage of total production. However, it will become more important for the following reasons.

- As the volume of production increases, greater development of the export market will be necessary to prevent oversupply and lower prices on the domestic market.
- Exports provide potential for a wider sales base without significant extra promotion. As such, it provides economies of scale and may extend or even out supply during the marketing period.

On the downside, export marketing has complex and specialised requirements. These include:

- access to knowledge and intelligence on export market requirements
- high levels of quality management and skills to consistently meet the market requirements
- commitment as relationships with export markets need to be developed on a long term basis
- sufficient volume to provide consistent supply
- in some cases, ability to meet strict quarantine requirements.

Consequently, exporting is normally only available to large growers, marketing groups or cooperatives, who market under common quality standards with an established brand image.

Current export destinations include Hong Kong, Malaysia, Singapore, Thailand, Taiwan and the Middle East. General preferences are for:

- large size fruit — count 23 or larger (smaller fruit is acceptable but will probably receive lower prices)
- sweetness (12% sugar)
- firmness
- freedom from skin blemish
- good colour and brightness (good yellow background with 50% or more red blush)
- sound packaging.

White fleshed peaches and nectarines are preferred in Taiwan.

Queensland has several strengths in the continuing development of exports. It is close to the growing Asian markets, its skill base enables good quality fruit with a clean, green image to be produced, its production is counter seasonal to most northern hemisphere producers, and it is growing varieties with a significant export demand. As a result, potential for export growth is sound. The major competition, however, will come from Chile, South Africa and Zimbabwe. Chile in particular can land fruit in an export market at a price significantly less than the Australian product.

Remember that as each export market has different quality requirements, seek the advice of exporters before proceeding.



Export associations  
Section 6 page 11



## Propagation

*Propagating low chill stonefruit is a specialised job, requiring significant skill. For this reason, we recommend that growers leave it to specialist nurseries who possess the appropriate skills and necessary equipment. However, because we get numerous enquiries from people wanting to understand the process, some basic notes on propagation are provided. Here is what you need to know.*

Overview .....	101
Raising rootstocks .....	101
Grafting and budding .....	102
After care of grafted and budded trees .....	106



### Overview

Low chill stonefruit is generally propagated by budding or grafting selected varieties (scions) onto special seedling rootstocks. It is vital that both the scion and rootstock are produced from virus-tested sources to prevent the introduction of serious diseases. Budding is most successful during autumn and grafting during spring. Propagation by cuttings is possible but there is as yet limited experience with the field performance of the resulting trees.

If a covered propagating shed is used, a grafted or budded tree suitable for planting out can be produced in about nine months.

Container-grown plants are easier to manage and handle than those grown in nursery beds. They can also be planted at any time of the year, generally establish better and grow away more quickly.

### Raising rootstocks

The most common rootstock used is coastal peach. Where soil nematodes are known to be a problem, a nematode-resistant rootstock such as Okinawa or Flordaguard should be used. These are generally available from seed sources around March to April each year. Only rootstock seed obtained from a virus-tested source should be used.

Seeds should be cracked to remove the kernels and the kernels immediately soaked in clean water for at least a day until they swell. The water should be changed every 24 hours. Seeds are then placed on absorbent paper towel, patted dry and germinated in shallow layers in

a sealable plastic lunch box. Place three or four layers of moist paper towel (soaked in water and then wrung out) on the bottom of the box, followed by a layer of seed, then another three or four layers of moist paper towel, then another layer of seed and so on until the box is filled. Before the lid goes on, place three or four layers of moist paper towel on top. As each layer of seed goes in, spray lightly with a fungicide solution to keep moulds to a minimum.

Place the lunch box in the bottom of a household refrigerator. Germination normally takes about five to six weeks, but each week, take the box out and examine the top layer for signs of germination. The first sign of germination is the small root (or radicle) emerging from the seed. When the radicle is about one centimetre long, remove seeds, dip in a solution of inoculant (for example Nogall) to protect seedlings against crown gall, and plant in a good quality soil-less seedling or potting mix in five to seven litre plastic pots (one seed per pot). Cover seed with about 5 to 7 mm of potting mix and water. Seedlings should emerge in about seven to ten days.

Seedlings require regular fertilising and watering. Regular checks must also be maintained for insect pests.

If seed is obtained in March/April, the seedling should be ready for grafting or budding in October/November and planting out in February. This assumes that during winter, seedlings are kept under cover and continue to grow.

Another alternative, where seeds can be obtained earlier, is to plant seed from late January/February, graft in July (not bud) and plant out in November. Trees will be into full production earlier than the February planting.

Seedlings are generally ready for budding or grafting when they are 50 cm or more high and as thick as a pencil.

## **Grafting and budding**

---

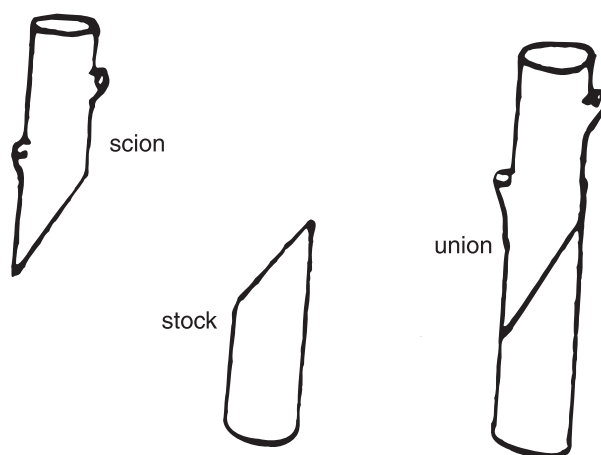
Use only budwood from a virus-tested source. Budwood obtained during winter can generally be stored in a refrigerator for at least one month before use. Budwood obtained during the growing season must be used immediately. Budsticks with two to three buds are best.

## **Grafting**

Grafting is preferred to budding as it generally produces a better shaped tree. The most common grafting techniques are the whip graft and the side veneer graft. The whip graft should only be used where the thickness of the scion wood and rootstock are similar. This enables a good match between the cambium layers of the scion and rootstock. The side veneer graft is recommended where the thickness of the scion wood and rootstock are substantially different. Most grafting is done in late winter or early spring using dormant hardwood budwood.

The whip graft is shown in Figure 37. Here is the technique.

1. Make a sloping cut on the base of the scion and on the top of the rootstock.
2. Bring the two cut surfaces together. If the rootstock and scion are of slightly different sizes, match the cambium layers on one side (the cambium layer is the slightly darker layer just under the bark).
3. Secure the graft union with grafting tape.
4. Seal the graft union by painting it with a mixture of white plastic paint and grafting mastic. To prevent dehydration, place a plastic bag over the scion and tie it off below the graft. Then cover the plastic bag with a brown paper bag to prevent sunburn.
5. When the graft starts to grow away, remove the bags and grafting tape.

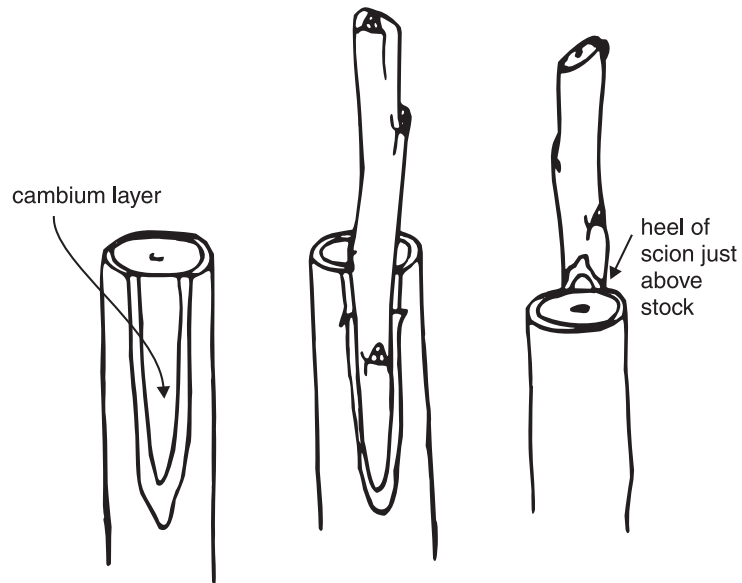


**Figure 37.** Whip graft

The side veneer graft is shown in Figure 38. Here is the technique.

1. Take the budstick and make a long sloping cut at one end.
2. Cut off the seedling at the approximate grafting point and then cut away a veneer of wood from the side of the stock. Cut the veneer at the point where the exposed cambium layers (the cambium layer is the slightly darker layer just under the bark) will match the cambium layers on the scion.
3. Bring the two cut surfaces together. Leave the heel of the scion just above where the stock has been cut off so that callus tissue can grow over the stock and seal it off.
4. Secure the graft union with grafting tape.
5. Seal the graft union by painting it with a mixture of white plastic paint and grafting mastic. To prevent dehydration, place a plastic bag over the scion and tie it off below the graft. Then cover the plastic bag with a brown paper bag to prevent sunburn.
6. When the graft grows away, remove the bags and grafting tape.





**Figure 38.** Side veneer graft

## Budding

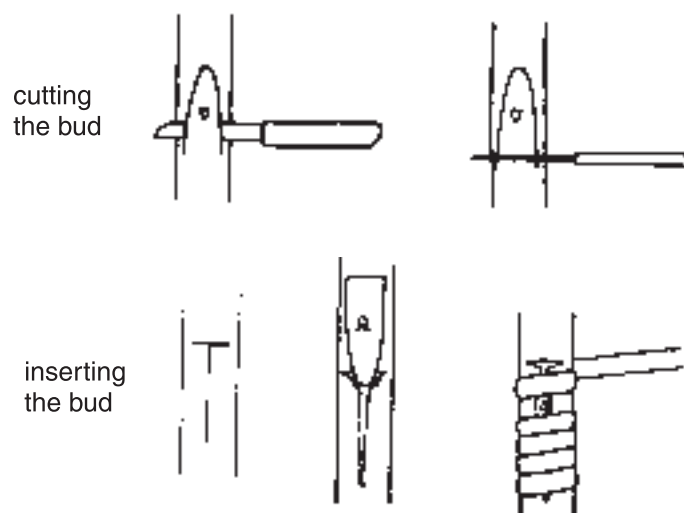
Budding is generally used where scion wood is scarce. This allows three or four buds to be obtained from one piece of grafting wood.

Budding must be done when the sap is flowing and the bark lifts easily. Two main budding techniques are used — T budding and patch budding.

T budding is shown in Figure 39. Here is the technique.

1. Cut the bud. Hold the budstick with the top of the stick pointing towards the body. Make a slice cut starting 10 mm below the bud, going under the bud and finishing about 10 to 15 mm above the bud. Make a second cut across the bud to remove it. The bud should be as thin as possible but thick enough to have some rigidity.
2. Clear a section of the stem of leaves and side shoots about 100 to 150 mm above the ground.
3. At this point, make a vertical incision about 30 mm long through the bark to the wood. Make a second crossways cut to complete the T by rolling the budding knife around the stock.
4. Gently lift the bark in the angles of the T with the tip of the knife.
5. Insert the bud at the top of the cut and gently push down under the flaps of the T until the top of the bud shield is level with the horizontal cut of the T.
6. Secure the bud by wrapping it with budding tape. The wrapping starts below the bud and finishes above the bud. The bud can be left exposed. If it is covered, it must be uncovered once the bud shoots.
7. Seal the bud union by painting it with a mixture of white plastic paint and grafting mastic. The stock above the bud union may be cracked and bent over to provide more energy flow to the bud. Do not cut the stock off at this stage.

8. After budding, keep the tree well watered to maintain sap flow and ensure a good bud take.
9. Cut the rootstock back to a point just above the bud once the bud has taken. Rub off any shoots or suckers from the rootstock.

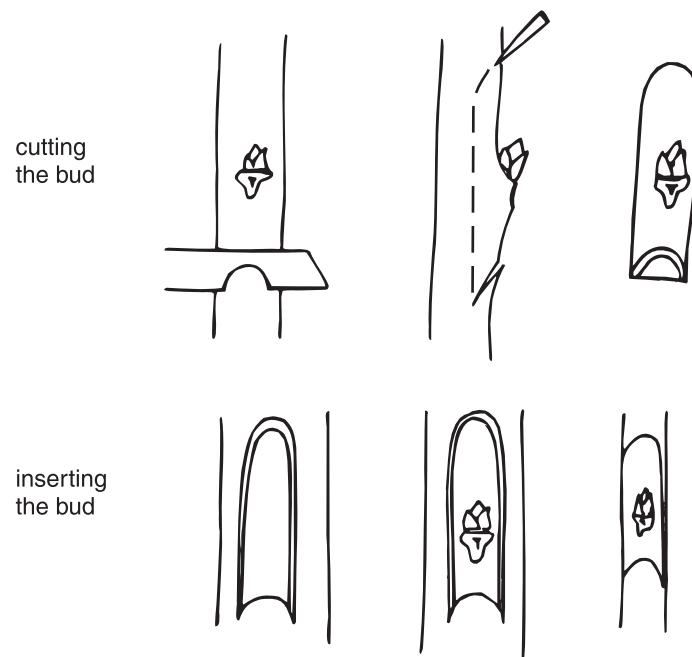


**Figure 39.** T budding

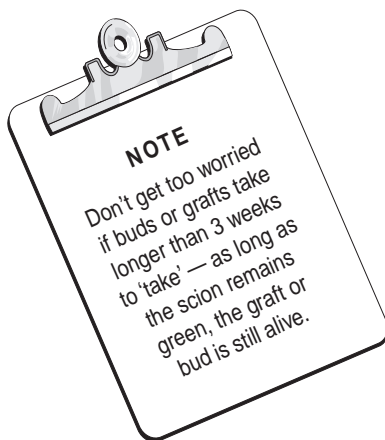
Patch budding is shown in Figure 40. Here is the technique.

1. Cut the bud. Hold the budstick with the top of the stick pointing towards the body. Make a slice cut angled downwards starting 10 mm below the bud. Then make a similar cut 10 to 15 mm above the bud and cut below the bud to the first cut. The bud should be as thin as possible but thick enough to have some rigidity.
2. Clear a section of the stem of leaves and side shoots about 100 to 150 mm above the ground.
3. At this point, make a slice cut angled downwards. Starting above this cut, remove a thin slice of the rootstock with a vertical incision down to the first cut. This slice should correspond in size roughly to the bud piece.
4. Insert the bud into the slice prepared and push it down firmly into its seat.
5. Secure the bud by wrapping it with budding tape. The wrapping starts below the bud and finishes above the bud. The bud can be left exposed. If it is covered, it must be uncovered once the bud shoots.
6. Seal the bud union by painting it with a mixture of white plastic paint and grafting mastic. The stock above the bud union may be cracked and bent over to provide more energy flow to the bud. Do not cut the stock off at this stage.
7. After budding, keep the tree well watered to maintain sap flow and ensure a good bud take.

8. Cut the rootstock back to a point just above the bud once the bud has taken. Rub off any shoots or suckers from the rootstock.



**Figure 40.** Patch budding



### **After care of grafted and budded trees**

After grafting or budding, place trees under cover to prevent excess moisture entering the graft or bud union. Maintain a warm humid microclimate. Keep soil moist but do not over-water. Regularly remove any suckers from the rootstock.

Successful grafts and buds generally take about three weeks to start to grow.