

Capsicum and chilli information kit

Reprint – information current in 1999



REPRINT INFORMATION – PLEASE READ!

For updated information please call 13 25 23 or visit the website www.deedi.qld.gov.au

This publication has been reprinted as a digital book without any changes to the content published in 1999. We advise readers to take particular note of the areas most likely to be out-of-date and so requiring further research:

- Chemical recommendations—check with an agronomist or Infopest www.infopest.qld.gov.au
- Financial information—costs and returns listed in this publication are out of date. Please contact an adviser or industry body to assist with identifying more current figures.
- Varieties—new varieties are likely to be available and some older varieties may no longer be recommended. Check with an agronomist, call the Business Information Centre on 13 25 23, visit our website www.deedi.qld.gov.au or contact the industry body.
- Contacts—many of the contact details may have changed and there could be several new contacts available. The industry organisation may be able to assist you to find the information or services you require.
- Organisation names—most government agencies referred to in this publication have had name changes. Contact the Business Information Centre on 13 25 23 or the industry organisation to find out the current name and contact details for these agencies.
- Additional information—many other sources of information are now available for each crop. Contact an agronomist, Business Information Centre on 13 25 23 or the industry organisation for other suggested reading.

Even with these limitations we believe this information kit provides important and valuable information for intending and existing growers.

This publication was last revised in 1999. The information is not current and the accuracy of the information cannot be guaranteed by the State of Queensland.

This information has been made available to assist users to identify issues involved in the production of capsicum and chilli. This information is not to be used or relied upon by users for any purpose which may expose the user or any other person to loss or damage. Users should conduct their own inquiries and rely on their own independent professional advice.

While every care has been taken in preparing this publication, the State of Queensland accepts no responsibility for decisions or actions taken as a result of any data, information, statement or advice, expressed or implied, contained in this publication.



Queensland Government



Growing **THE CROP**

This section is our recipe for growing and marketing a commercial crop of capsicums or chillies for the fresh market. Where the term 'capsicum' is used it refers to both capsicums and chillies. To keep the section as brief as possible and easy to follow, we provide little explanation with recommendations. Where more information may help, we refer you to other sections of the kit. Symbols on the left of the page will help you make these links.



Getting the crop started

3

How to get ready for planting, and planting the crop



Planting to early fruit set

24

Things to do from planting to early fruit set



Early fruit set to first harvest

36

Things to do from early fruit set to first harvest



During harvest

39

Things to do during harvest



Fruit handling and marketing

43

The steps from harvesting to marketing

The capsicum plant

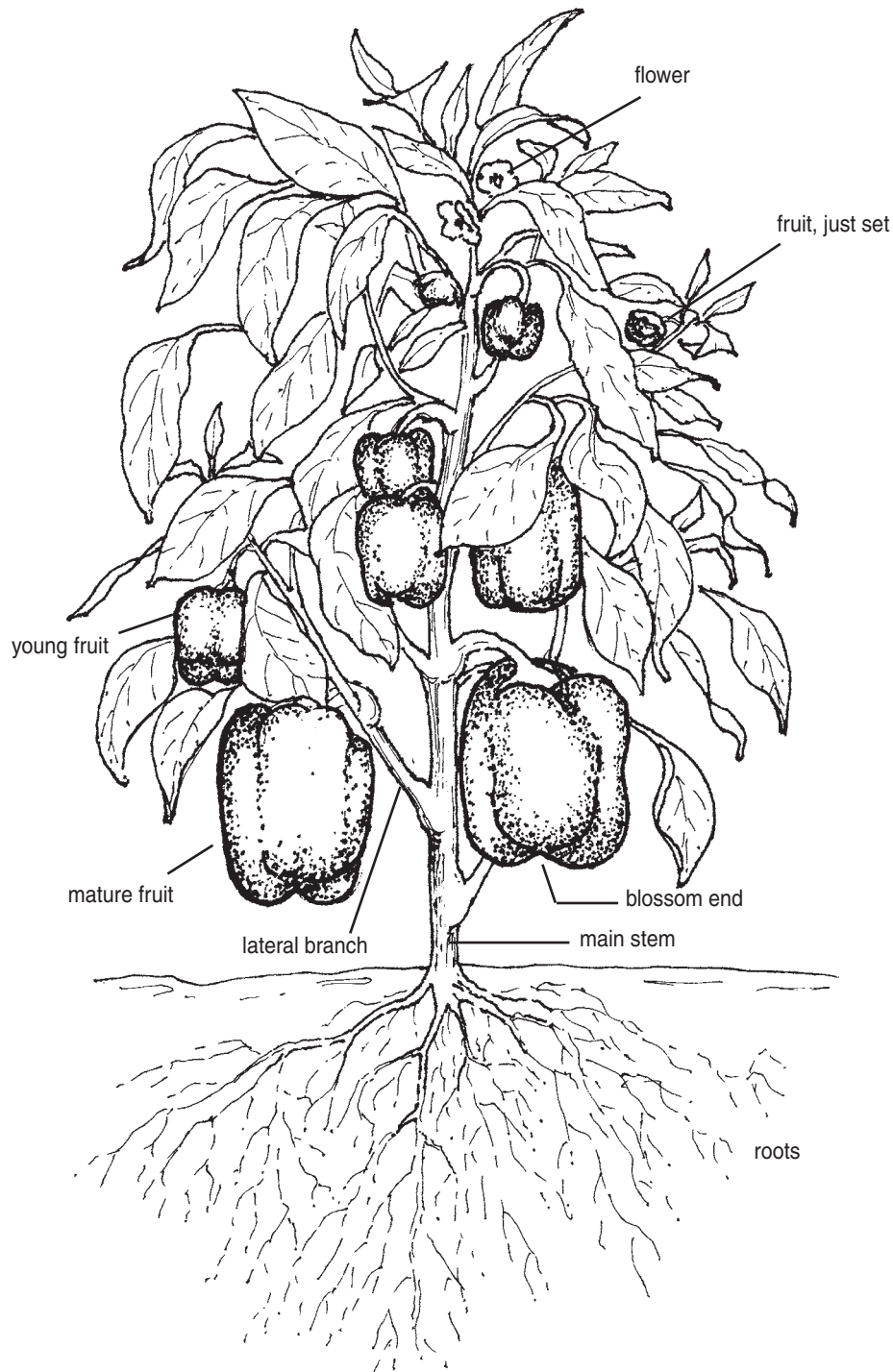

Figure 1. Parts of the capsicum plant



Getting the crop started

To give yourself the best chance of success, you need to start planning your crop and preparing the land at least six months before planting. This involves 12 key steps.

Decide when to plant.....	3
Decide whether to buy plants or grow your own.....	4
Select varieties	5
Work out number of transplants needed and order	5
Choose an irrigation system	8
Prepare the land.....	9
Lay out the field.....	15
Apply fertiliser	17
Control weeds	19
Form the beds and lay the mulch	19
Look after transplants until planting	21
Plant.....	22

Decide when to plant

Recommended times

The timing of a capsicum or chilli crop depends on the seasonal temperatures to be experienced by the crop and the market to be supplied. The main planting and harvesting times are shown in Table 1.

Table 1. Main planting and harvesting times

District	Transplant	Harvest
Dry tropics	late February – early September	May – December
Bundaberg	January – April mid-July – September	April – August October – January
South-east Queensland	late August – February	November – May
Granite Belt	October – December	January – April

Growing times in south Queensland can extend out of these main seasons but yields and quality are reduced due to problems with pollination in cold and hot weather.

In north Queensland crops grown in hot weather, after the main

season, may suffer from sunburn and wind and rain damage, leading to increased pest and disease pressure.

Temperature

Growth is inhibited below 10°C. Avoid increasing application of water and fertiliser in an attempt to boost growth at low temperatures as this can damage plants.

Capsicums are particularly sensitive to cold. Temperatures below 4°C may result in freezing of the foliage and fruit in the field. When growing seedlings, the use of plastic-covered igloos or any similar structure covered with plastic will reduce frost risk.

Temperatures below 15°C or above 32°C for prolonged periods reduce pollen viability and pollination. This leads to small and/or deformed fruit.

Crop cycle

Table 2 shows the normal time range for each stage of plant growth. The short intervals occur in the hotter weather while each stage takes longer in cool conditions.

Table 2. Normal time range for each growth stage

Plant stage	Time
Sowing to germination	5 – 21 days
Emergence to field planting	4 – 8 weeks
Field planting to first flower	3 weeks
First flower to harvest	9 – 14 weeks
Duration of harvest	3 – 6* weeks

* Chillies may be harvested for much longer

Decide whether to buy plants or grow your own

Unless you are experienced in growing seedlings we recommend that you buy transplants from an established nursery. There are several nurseries that supply plants in each district.

Nearly all capsicums are planted as container-grown transplants. These plants are usually very uniform in size and growth. Container-grown seedlings suffer little if any transplanting shock or plant loss when properly planted out. Plant loss can be high, however, if seedlings are planted in hot windy weather, left unirrigated after planting or have been grown very rapidly and the plants are soft and spindly.

Plants are started in trays that consist of a large number of cells. Seed is planted in a seedling mix in the individual cells. Seedlings are transplanted into the field once they will pull cleanly out of the tray, that is when the roots have fully penetrated the mix. This is usually about when the fourth to sixth true leaf has just emerged.

Growing transplants is time consuming and requires some extra in-



Nurseries
Section 6 page 5



Growing transplants
Section 4 page 15



Varieties and disease
resistance
Section 4 page 21

frastructure. If you decide to grow your own transplants you should do a cost benefit analysis to determine whether it is economically viable. You will need above-ground racks; a watering and fertigation system; and an area to mix the potting mix and plant the seeds. You will also need to buy seedling trays, potting mix, a mixer, seeder, cleaning and sterilising equipment, and a plastic igloo for growing in cool weather.

Select varieties

Variety selection is an important decision as there is no one variety that performs best across all planting seasons and production techniques. Factors to consider include fruit shape—tapered or blocky; size; yield; disease resistance and the climatic stresses during the production period; particular market requirements; and, for chillies, how hot they are. The main varieties grown in each district are listed in Table 3.

Table 3. The main capsicum and chilli varieties grown in each district

District	Main varieties	
	Capsicums	Chillies
Bowen	Aries, Merlin, Target	Caysan, Firefly, Inferno, Long Cayenne
Bundaberg	Aries, Belair, Blockade, Eclipse, Merlin, Raptor, Rex, Target	Cayenne, Caysan, Habanero, Hotline, Inferno, Inferno Birdseye, Long Zippy
South-east Queensland	Aries, Merlin, Target	Inferno, Jalapeno
Granite Belt	Merlin, Heldor, Target	Banana Supreme, Long Sweet Yellow

Work out number of transplants needed and order

Row width and plant spacing

Most capsicum and chillies have been planted in double rows 30 to 40 cm apart on beds with centres 1.5 m apart. Plants are staggered 40 cm apart down the row so that they are not directly opposite. There is now a strong trend to planting single rows 1.5 m apart with plants 15 to 20 cm apart; some growers prefer to plant single rows 1.2 m apart.

The closer spacing between plants is used in hot weather to help prevent sunburn. Closer spacing in winter may result in more disease problems, as plants stay wet longer because airflow between them is restricted.

Deciding how many plants you need

Single rows

A commonly used planting arrangement for single rows is shown in Figure 2.

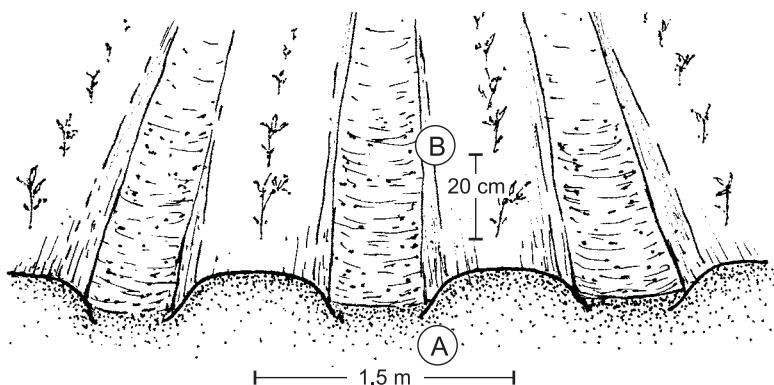

Figure 2. A commonly used planting arrangement for single rows

Excluding headlands, the number of plants required per hectare (10 000 sq. m) is determined by the:

- distance in metres between the centre of each bed (A)
- distance in metres between plants in the row (B).

Use a calculator to calculate the following formula:

$$(10\ 000 \div A) \div B$$

For example: How many plants will you need at 1.5 m bed centres (A) and 20 cm (0.2 m) between plants (B)?

$$10\ 000 \div 1.5 = 6667 \div 0.2 = 33\ 335 \text{ plants per hectare}$$

Double rows

A commonly used planting arrangement for double rows is shown in Figure 3.

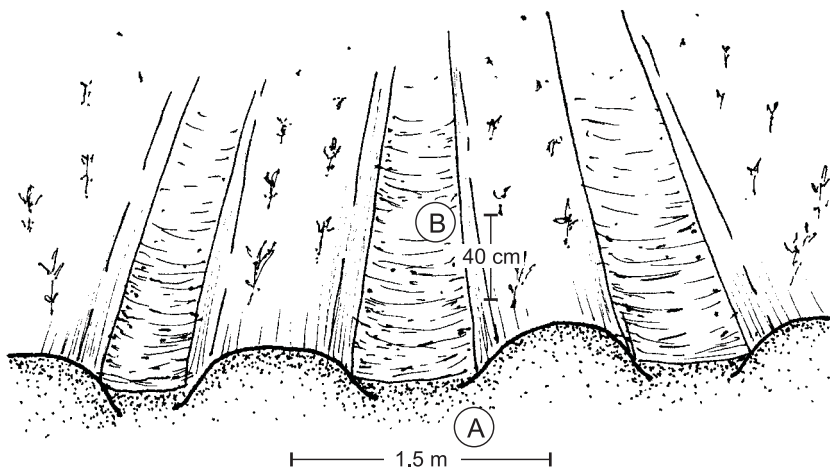

Figure 3. A commonly used planting arrangement for double rows

Excluding headlands, the number of plants required per hectare (10 000 sq. m) is determined by:

- the distance in metres between the centre of each bed (A)
- the number of rows on each bed (2)
- the distance in metres between plants in the row (B).

Use a calculator to calculate the following formula:

$$(10\ 000 \div A) \times 2 \div B$$

For example: How many plants will you need for double row beds at 1.5 m bed centres (A) and 40 cm (0.4 m) between plants (B)?

$$10\ 000 \div 1.5 = 6667 \times 2 = 13\ 334 \div 0.4 = 33\ 335 \text{ plants per hectare}$$

To help you, Table 4 shows our calculations for several different row and plant spacings.

Table 4. Number of plants per planted hectare at different row and plant spacings

Row type	Between row centres	Between plants	Plants per planted hectare (approx)
Single rows	1.2 m	15 cm	55 555
		20 cm	41 665
		25 cm	33 335
	1.5 m	15 cm	44 445
		20 cm	33 335
		25 cm	26 665
Double rows	1.5 m	30 cm	44 445
		40 cm	33 335
		50 cm	26 665
	1.8 m	30 cm	37 035
		40 cm	27 775
		50 cm	22 220

Note: The length of rows and the size of headlands will determine what area is required to plant one hectare of crop.

Order transplants or seed

Contact transplant or seed suppliers for details of what varieties they have, when they will be available and the price and delivery arrangements. Do this at least three months before your proposed planting date, or better still, when you are planning your planting schedule before the season starts. Ordering early gives you the best chance of getting the varieties you want when you want them.

On average there are between 120 and 160 capsicum seeds per gram, that is 120 000 to 160 000 seeds per kilogram. Remember that not every seed will germinate, so take note of the germination percentage on the pack of seed you are buying.

Choose an irrigation system

Capsicums have a high water requirement because of their shallow root system. They should be kept moist at all times; even with plastic mulch seedlings will need watering every day during dry periods. Moisture stress and/or poor quality water can lead to severe blossom-end rot problems. Do not over water as this can predispose the plants to sudden wilt, causing serious plant loss.

Water use should be monitored with tensiometers for the most efficient management with trickle irrigation.

Consult an irrigation equipment supplier or designer in your area and get them to develop an irrigation plan.

Methods of irrigation

Trickle irrigation is the best and most common method of irrigation. Furrow and overhead irrigation is sometimes used but this can increase the risk of leaf and fruit diseases.

Trickle irrigation is the most easily controlled and efficient irrigation method. The equipment is expensive, but has a long life. If trickle tubing is to be re-used it should be treated with chlorine to reduce the risk of blockages. Soluble fertilisers can be applied easily through the irrigation system and this ability to fertigate is a major advantage of trickle irrigation. The water must be checked for iron bacteria and treated if necessary.

Furrow irrigation requires an even, gentle slope and a soil type that allows water to spread laterally without penetrating too deeply into the soil. Furrows longer than 200 m are not recommended. 'Tail end' water from the end of the rows must be removed to prevent waterlogging of the lower section of the block.

Overhead irrigation includes travelling irrigators and sprinkler systems. It is suitable for any soil type and undulating country. Overhead irrigation can increase the risk of leaf and fruit diseases and is rarely used for capsicums. Poor quality water applied over the plants will cause leaf damage.

Water quality

Capsicums will not tolerate saline irrigation water. When grown under furrow or trickle irrigation, water with an electrical conductivity (EC) up to 2000 microSiemens per centimetre ($\mu\text{S}/\text{cm}$) can be used on some soils provided careful management practices are followed. Capsicums grown under overhead irrigation are more sensitive to saline irrigation water because of leaf contact with the water.

Some reduction in plant growth and yields may occur if EC levels above 1200 $\mu\text{S}/\text{cm}$ are used. Blossom-end rot is likely if EC levels are above 2000 $\mu\text{S}/\text{cm}$.



Irrigation methods
Section 4 page 49

Water quantity

Up to 4 megalitres (ML) per hectare of water is required for trickle irrigation. Slightly higher rates are applied when using sprinkler irrigation. For furrow irrigation the figure can vary from 3 to 6 ML per hectare.

The amount of water required also varies with the locality and the soil type. As a general rule capsicums require 30 to 40 mm of irrigation per week. Sandy soils have a much lower water-holding capacity than clay-based soils and consequently need more frequent irrigation. The soil texture will also determine the amount of water applied at any one time. The use of plastic mulch will reduce water use and improve lateral spread of water on some soil types. Water requirements are higher in hot weather than cool weather.

Capsicums have a restricted root system, so avoid over watering by applying frequent light irrigations.

A commonly used trickle irrigation tube with 20 cm outlet spacing and operated at 0.55 bar (8 psi) inlet pressure should deliver about 500 L per 100 m of row per hour. The actual quantity applied will vary depending on the amount of slope, the pressure and whether the tubing is clean.

Prepare the land

Protect against wind

Capsicum plants are very brittle and strong winds may cause limb breakage and unsightly rub marks on the fruit, reducing its consumer acceptability. Wind will also cause increased water loss and reduce growth. The most critical stage is when the plants are carrying a heavy crop.

Some growers plant tall growing sorghum every couple of beds two to three weeks before the crop is planted as additional wind protection. More permanent windbreaks (bana grass or an artificial windbreak) will greatly reduce these problems. Tree windbreaks may be practical in some situations (Figure 4).



Figure 4. Tree windbreaks protecting a capsicum crop

more info



Pictures of damage
Section 5

Windbreaks are rarely used in north Queensland. In some areas of south Queensland, blocks of sugar cane act as windbreaks for part of the year.

Protect against soil erosion

Steep slopes can cause soil erosion. Even, gentle slopes (about 0.5%) are essential for furrow irrigation as soil depressions may lead to waterlogging. If trickle or sprinkler irrigation is used uniform slopes are preferred but not essential.

Whichever irrigation system is used some form of land levelling is necessary, as capsicums are highly prone to waterlogging. Laser levelling is carried out in most growing districts and will improve irrigation efficiency.

Uncontrolled runoff water removes valuable topsoil while the land is being prepared.

There are six important steps in avoiding erosion from runoff.

1. Build a grassed contour drain across the top of the block. This drain should have a grade of between 2 and 4% and will catch runoff water from above the block and divert it into waterways running down the slope.
2. Space waterways 50 m apart. Make them flat-bottomed, at least 2 m wide and lower than the surrounding land. Where possible, use natural depressions in the block.
3. Form beds parallel to the top drain so that water can be channelled between the beds into the waterways.
4. Build trafficways beside the waterways.
5. Plant seed or runners of couch, kikuyu or carpet grass in the base of waterways and trafficways. Once these structures are established, they can remain as permanent fixtures.
6. Run beds across the slope, parallel to the contour drain. This layout minimises loss of soil between beds and combines good water infiltration and safe removal of runoff.

These layouts can be used safely on all slopes with a fall of up to 8%. Capsicums should not be grown on steeper slopes.

Land conservation extension officers with the Department of Natural Resources provide free on-site advice on farm layout.

Crop rotation

Capsicums belong to the same family as tomatoes, eggfruit and potatoes so they are subject to similar pests and diseases. To avoid disease build-up, these crops should not follow each other in the same year. The period between replanting the same field will depend on the area available for cultivation but should be no less than one year. Most other crops can be used in a rotation.

Cover crops in rotation with cash crops improve soil structure and



Conservation officers
Section 6 page 19

productivity and reduce pest and disease problems. Cover cropping combined with other soil conservation methods, such as contour banks on steeper slopes, will reduce erosion and help maintain your most valuable asset, your soil.

A guide to land preparation

Table 5 shows a suggested land preparation schedule based on the number of weeks before planting.

Table 5. A suggested land preparation schedule for capsicums

Weeks before planting	Activity
20	Cultivate soil, rip and fertilise if necessary, or add organic material. Plant green manure crop.
10 – 12	Slash or cut with a mulcher to avoid hard fibrous stems.
8	Sample soil for a nutrient analysis.
4 – 6	Mulch then plough in green manure crop. Apply and incorporate lime, dolomite or gypsum according to soil nutrient analysis results.
2 – 4	Disc-cultivate soil once or twice to speed break down of green manure crop.
0 – 1	Final working of soil just before planting.
0	Plant the crop.

Initial cultivation. If your land is under grass or weeds, plough or disc-cultivate the block. A hard pan or compaction layer may be formed from regular use of a rotary hoe and other cultivation equipment or from heavy traffic movement (Figure 5). This causes reduced plant growth and waterlogging in some situations. If you suspect that you may have a hard pan, dig a hole and check. Deep rip in both directions to break this hard pan. If the soil is wet it will not shatter; if too dry large cods will be formed.

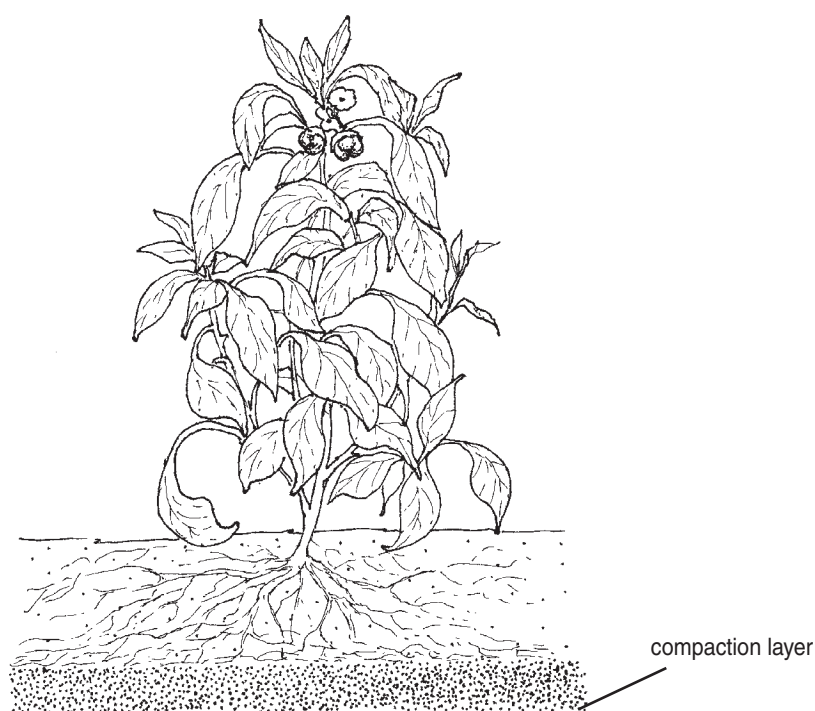

Figure 5. Root system affected by a compaction layer

Ripping is best immediately after final harvest to allow water to penetrate deeply during fallow and salts to be leached out of the root zone.

In self-mulching clay soils of the Lockyer Valley, the hard pan may be broken by using a summer forage sorghum crop. This crop dries the soil profile, causing shattering of the compacted layers. On these soil types, this practice has been shown to be more effective than deep ripping.

Organic additives. Organic additives such as filter press or mill mud from sugar mills (15 t/ha), deep litter fowl manure (5 t/ha) or cattle feedlot manure (10 t/ha) may be used to increase organic matter in the soil. They should be applied before a cover crop is planted.

Cover crops or green manure. Cover crops help to build up soil organic matter, which is reduced by cultivation. These crops are particularly important in light, sandy soil. Organic matter is usually expressed as organic carbon in a soil analysis. Other benefits of cover crops include:

- improved soil structure and internal soil drainage
- improved water-holding capacity
- reduced leaching of nutrients
- increased activity of micro-organisms
- reduced soil erosion
- reduced pest and disease problems
- reduced weed growth
- recycling of nutrients.

If growth is slow apply 100 kg/ha of nitram (30 kg/ha of nitrogen) after emergence. A well grown cover crop will add more organic matter and help smother weeds. Extra nitrogen may be needed if the cover crop is slashed several times.

Legumes such as cowpea and dolichos are susceptible to nematodes.

Summer. Broadcast hybrid forage sorghum seed over the cultivated land at 20 to 30 kg/ha. Use the higher rate where the seedbed is rough and the seed will not have good soil contact. For best germination, use harrows or a light tined implement after planting to mix seed into the soil. Light rolling will improve germination by ensuring that seed is in closer contact with the soil. Water as required.

Forage sorghum can be ratooned several times by slashing. Extra nitrogen may be required if the crop is slashed and allowed to regrow. Slash back to a height of 20 to 30 cm, or plough in before seed heads develop and the stems get too fibrous to decompose rapidly.

In north Queensland, the legume dolichos or hybrid forage sorghum is planted from November to January. Dolichos is susceptible to silverleaf whitefly and should not be used where whitefly is a problem.

Winter. Few northern producers grow a winter cover crop. In south

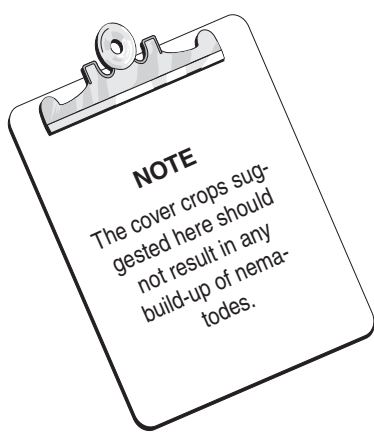

Queensland cereals such as oats, triticale or barley at 75 kg/ha are suitable. Use oats for early planting and barley for late planting.

Soil analysis. A soil analysis takes the guesswork out of fertiliser scheduling. Take the sample six to eight weeks before your intended planting date. Follow the sampling instructions supplied by the laboratories.

A soil analysis measures the pH, conductivity, organic matter and the level of nutrients in the soil. Results will be interpreted by the laboratory and should be back in about two weeks, allowing time for the treatments to be incorporated into the soil. Your experience of the block of land, and the way you wish to manipulate the growth pattern of the crop, will influence your interpretation of the soil analysis.

Soil pH. The pH level is a measure of the soil's acidity or alkalinity on a scale from 0 to 14, with 7 being neutral. A pH of 5 is 10 times more acid than a pH of 6. Capsicums prefer a slightly acid soil, around 6.0 to 6.5. In this range, most major and trace elements present in the soil are available to the plants, without being at toxic levels. Many Queensland soils are acidic and require the addition of lime or dolomite to raise the pH. A complete soil analysis will show which form is most suitable by showing the available levels of calcium and magnesium. Table 6 is a guide to the application rates for lime or dolomite.

Table 6. Lime or dolomite needed to raise soil pH to about 6.5

Soil type	Sandy loam	Loam	Clay loam
pH range	t/ha	t/ha	t/ha
4.5 – 5.0	5.00	6.25	7.50
5.0 – 5.5	2.50	3.75	5.00
5.5 – 6.0	1.25	2.50	3.75

Gypsum. Application of gypsum will increase soil calcium levels but not change soil pH. Naturally occurring gypsum is preferred to phosphogypsum in vegetable crops because of the cadmium in phosphogypsum. It takes about one year for the effects of gypsum to become apparent. Apply gypsum before the wet season so that it can leach accumulated salts beyond the root zone well before planting. Soil must have good internal drainage to benefit from gypsum. Table 7 shows the appropriate management of calcium, magnesium and pH.

An application of 5 to 10 t/ha of gypsum can benefit heavy clay loams that have high sodium levels and a pH higher than 8.0.

Calcium (Ca). Deficiency is associated with blossom-end rot of fruit and has also been implicated with the fruit-spotting condition called Yolo spot or green spotting. For reasons not well understood, plant deficiency can occur in soils with adequate levels of calcium present. Uneven soil moisture and poor water quality increases the severity of the problem. Apply lime, dolomite or gypsum as recommended by the soil analysis.

Magnesium (Mg). Magnesium can be deficient, particularly in high rainfall areas and where soils are fairly acid. Apply dolomite or spray

with magnesium sulphate (MgSO₄) as recommended by the soil analysis. Magnesium sulphate may also be injected through the trickle system at 15 to 20 kg/ha. Excessive use of calcium and potassium-based fertilisers can induce magnesium deficiency. Table 7 is a guide to which product is most suitable for your situation.

Table 7. Management of calcium, magnesium and pH

Recommended action	Soil nutrient status							
	pH high				pH low			
	Calcium high		Calcium low		Calcium high		Calcium low	
	Mg high	Mg low	Mg high	Mg low	Mg high	Mg low	Mg high	Mg low
Gypsum 1.0 – 2.0 t/ha			✓	✓				
Dolomite 2.5 – 5.0 t/ha						✓		✓
Lime 2.5 – 5.0 t/ha					✓		✓	
Magnesium sulphate (MgSO ₄) 100 – 250 kg/ha	✓		✓		✓			

Final land preparation. Plough in the organic matter to 20 to 25 cm deep, then work the soil to a fine tilth for planting. All organic matter should be incorporated into the soil well before planting to allow it to decompose completely to avoid serious losses from damping-off diseases. Decomposition takes about four weeks in warm, moist soil and eight weeks or longer in cold or dry weather.

In very dry conditions it may be necessary to apply about 25 kg/ha of urea and irrigate to encourage decomposition by soil micro-organisms. Otherwise the organic matter decomposes when the crop is first irrigated, resulting in heavy seed and plant losses.

Soils are normally worked twice with disc or tine cultivators and then brought to a clod-free condition using rigid or spring tine cultivators and harrows. A rotary hoe is used for final land preparation when applying fertiliser and bedding up.

Trace elements

Other elements may also be deficient in some soils and may need to be corrected. A complete soil analysis taken six to eight weeks before planting will indicate which elements are deficient. These can either be applied to soil before planting (preferred) or as foliar applications once the plants are established. Soil applications often last a few years, whereas foliar applications only affect the plants they are applied to.

Boron (Bo). Deficiency is more likely in neutral to alkaline sandy soils, particularly if they have recently been heavily limed or are low

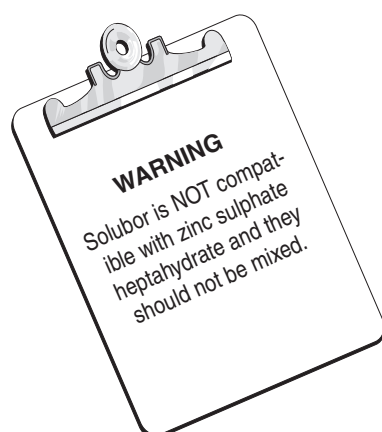

in nitrogen. Apply as a foliar spray in these situations.

Zinc (Zn). Soil applications are most effective. Applications may be broadcast over the entire area or banded in the rows at rates up to 10 kg/ha of zinc. The higher rates may remain effective for several years. Zinc may also be applied to the crop as a foliar spray if required.

Soil applications are best made using zinc sulphate monohydrate (35.5% Zn). Zinc sulphate heptahydrate (22.7% Zn) can be dissolved in water and sprayed onto the soil using a boom spray or injected through the trickle irrigation system. Table 8 shows soil application rates for boron and zinc.

Table 8. Soil application rates for boron and zinc

Element	Product	Rate/ha	Comments
Boron	Solubor	5 kg	Spray on the soil. Solubor is NOT compatible with zinc sulphate heptahydrate.
Zinc	zinc sulphate monohydrate	10 – 20 kg	Spray on the soil three weeks before planting and work it in.
	zinc sulphate heptahydrate	20 – 30 kg	Spray on soil or apply through the trickle irrigation. Do not mix with boron.

Lay out the field

The area to be planted is divided into lands, each land being twice the operating width of the spray equipment to be used (Figure 6). Access tracks of 3 to 4 m wide are run between these lands. Row spacing within each land is normally 1.5m. Lands usually consist of seven to 10 rows.

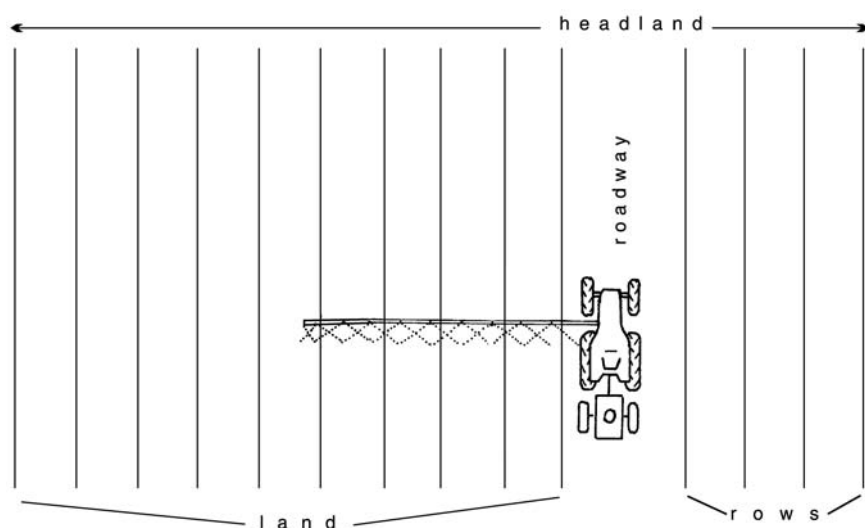

Figure 6. Field layout in relationship to the width of a boom spray

The length of row used with trickle irrigation depends on the slope of the land. Under ideal conditions the accuracy of water distribution decreases after about 120 m. Additional 'lay flat' tubing can be placed

across the rows to increase row lengths.

In south Queensland it is preferable to have the rows orientated north-south. This allows better light penetration and air movement, reducing humidity and thus disease outbreaks.

If possible, divide blocks into uniform soil types for easier and more efficient cultivation, irrigation and fertilising. Provide all weather access to the block and allow room for vehicles to turn easily at the end of the rows. Design the layout so that new plantings are made into the wind to reduce pest and disease movement from older plantings.

Mark out rows

Rows are marked out using the wheel marks of a tractor set at the normal row spacing. After the first row is marked out the driver need only follow on the outside wheel mark to obtain the correct spacing. Pre-plant basal fertiliser can be applied when the rows are marked out.

Capsicums are relatively tolerant of nematodes and control measures are rarely needed. If good crop rotation and soil management is followed no further nematode management strategies should be necessary.

Soil nematode counts are a useful guide, but can be misleading, because some nematodes survive deep down and move up to the root zone once soil moisture improves. Check the previous history of the block or dig up some susceptible host plants and check roots for nematode galling. A nematicide or fumigant may be used as insurance against future losses because once plant damage is noticed it is too late to control the nematodes. Chemicals used to control nematodes and some weeds and diseases are listed in Table 9.

Table 9. Chemicals used to control nematodes and some weeds and diseases

Chemical	Trade name	Rate	Comments
chloropicrin	Chloropicrin	300 – 600 g/20 sq.m	See label for details. Also controls some soil fungi and weeds.
dazomet	Basamid	600 – 700 kg/ha (60 – 70 g/sq.m)	See label for details. Also controls some soil fungi and weeds.
metham-	Metham	250 – 800 L per treated hectare	Soil injection or through sodium certified trickle irrigation systems. See label for details. Also controls some soil fungi and weeds.
methyl bromide	Brom-O-Gas 1000	50 – 100 g/sq.m	See label for details. Also controls some soil fungi and weeds.
methyl bromide + chloropicrin	Brom-O-Gas 980, Vertafume	50 – 100 g/sq.m 500 kg/ha	See label for details. Also controls some soil fungi and weeds.



Alternatives to methyl bromide
Section 4 page 91

Fumigation

Fumigation refers to the injection or incorporation of chemicals into the soil before planting to control nematodes, weeds and some soil-borne pests and diseases. Use a broad spectrum fumigant such as chloropicrin, methyl bromide, metham-sodium or dazomet.

The chloropicrin/methyl bromide fumigant is an extremely efficient chemical on nematodes. However, it is costly, and its use can only be justified if other soil diseases and weeds such as nut grass are an anticipated problem. Although methyl bromide is gradually being phased out it is still the recommended fumigant.

Before application, work the soil to a fine tilth to 25 cm deep. Soil must be moist but not wet, free from clods and undecomposed organic matter, and warmer than 10°C. Methyl bromide is highly toxic and is applied under plastic sheeting. Hire an experienced operator with the necessary specialised equipment to perform this operation safely.

There are two ways of applying the fumigant:

- fumigate the whole block before the beds are formed;
- only treat the strips to be planted. (The beds are formed, the fumigant applied and the plastic mulch laid, all in the one operation. This is cheaper, but diseases and weed seeds can remain between the rows in the unfumigated soil.)

After treatment the soil must be aerated to allow the gas residues to escape or plants can be damaged. If the whole block is fumigated, remove and discard the covering sheet. If strips are fumigated, leave the plastic mulch in place and delay planting for at least one week and probably longer in winter. If cress or lettuce seed will germinate in the treated soil, it is safe to plant.

Apply fertiliser

Capsicums require careful nutritional management to ensure high yields of top quality fruit. Follow the recommendations of your soil analysis when applying fertiliser. Nutrients must be balanced to achieve early vigorous vegetative growth followed by heavy flowering and fruit set on less vigorous growth. This should lead to a high yield of fruit.

Fertilisers are commonly sold as mixtures of nitrogen (N), phosphorus (P) and potassium (K). The percentage of each of these elements in the mix is expressed as a ratio of N:P:K. For example 100 kg of a fertiliser with an N:P:K ratio of 13:15:13 contains 13 kg nitrogen, 15 kg phosphorus and 13 kg potassium.

Fertilisers should be applied before planting (pre-plant) and as side dressings (post-plant) as the crop grows.

Pre-plant (basal) fertiliser

The pre-plant or basal fertiliser should provide an even, vigorous but not over-vegetative capsicum bush. The plants should develop a



Nutrition
Section 4 page 37

strong root system and early bush structure that can support a heavy crop. Generally about 30% of the total nitrogen requirement, all the phosphorus and 30 to 50% of the potassium should be applied before or at planting. Where methyl bromide is used, pre-plant nitrogen may need to be reduced by 20% to prevent excessive vegetative growth.

Apply the pre-plant fertiliser to the soil surface in a 60 cm wide band and incorporate the fertiliser with a rotary hoe during final soil preparation or bed-forming. On some soils (mainly krasnozems and red earths) where phosphorus may be tied-up in the soil, basal fertilisers are drilled into the bed in narrow and 10 cm to the side and below the plant roots (Figure 7).

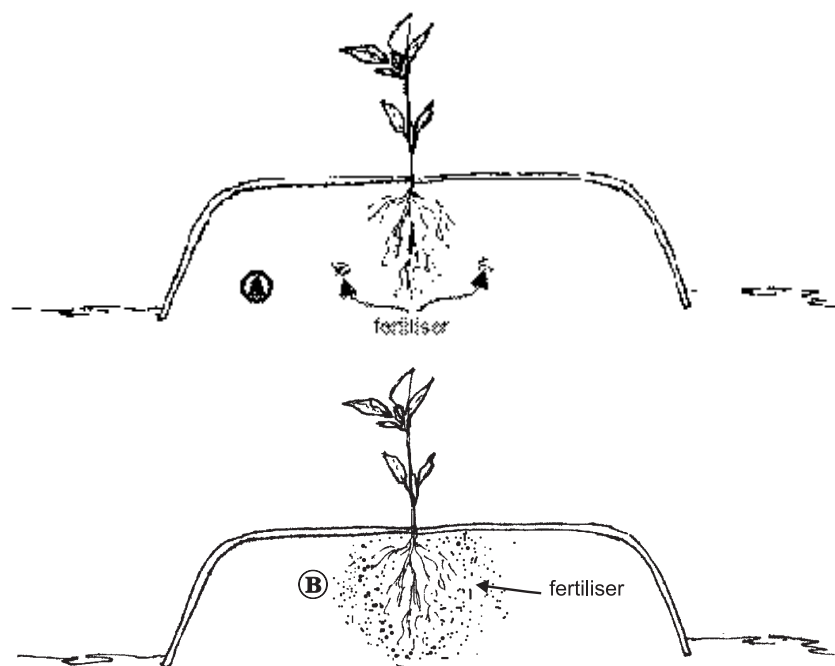

Figure 7. Pre-plant fertiliser, (A) drilled and (B) banded

Major elements

Pre-plant fertiliser requirements are best determined from the results of a complete soil analysis. If a soil analysis is not used, apply a pre-plant fertiliser which will supply about the following rates: 45 kg of nitrogen (N), 50 kg of phosphorus (P) and 50 kg of potassium (K) per hectare. For a fertile soil the minimum rates to apply are 30 kg of nitrogen, 30 kg of phosphorus and 40 kg of potassium per hectare. Apply fertiliser in a band or incorporate within the plant rows. Table 10 shows fertiliser rates for two common N:P:K mixtures.

Table 10. Fertiliser rates for two common N:P:K mixtures

N:P:K mixture	Quantity to apply	
	kg/ha	kg/20 m of bed
5:6:5	900 – 1000 kg	2.7 – 3
13:15:13	350 – 400 kg	1.1 – 1.2

On high phosphorus level soils use a 15:4:12 or similar mixture. Other elements that are required in relatively large amounts include calcium, magnesium and sulphur.

Sulphur is usually found in sufficient quantities in most commercial N:P:K fertilisers, superphosphate, gypsum and sulphate of potash. Lime, dolomite and gypsum are sources of calcium. Dolomite and magnesium sulphate are sources of magnesium.

Control weeds

Weed control begins with the ploughing out of the previous crop before weed seeds can germinate. Regular cultivation with tined implements will prevent a build-up of weeds and cause less damage to soil structure than discs or a rotary hoe. If a good cover crop is planted, most weeds will be smothered. Weed control strategies should start before bed-forming.

The interval between cultivations before bed-forming allows some weed seeds to germinate and these are killed by the following cultivation. This reduces the overall seed population on the block.

There are no residual herbicides registered to control weeds in capsicums. Plastic mulch gives excellent weed control over most of the cropped area. Nut grass will grow through plastic mulch so consider pre-plant strategies such as fumigation or block selection for its control. Weeds in the unmulched interrow strips can be controlled in their early growth stages by cultivation or by a low pressure, directed, desiccant spray with (for example paraquat) using shielded fan nozzles.

Methyl bromide will control nut grass and prevent it from growing through the plastic mulch. Where plastic mulch is not used, weeds can be controlled by interrow cultivation, hilling, hand chipping or the use of herbicides.

Some weeds may grow up through the planting holes around the plants. Fumigation before planting will reduce this. Any weeds that do grow must be removed by hand.

Form the beds and lay the mulch

Plastic mulch

If plastic mulches are to be used it is essential to install trickle irrigation for water and nutrient application (fertigation). Table 11 shows the advantages and disadvantages of using plastic mulch and trickle irrigation.

Table 11. *Advantages and disadvantages of plastic mulch and trickle irrigation*

Advantages	Disadvantages
<ul style="list-style-type: none"> • Marketable yields are always increased. • Mulches reduce water use by preventing moisture evaporation from the soil. • Reduces the risk of fruit drop and blossom-end rot disorder because of more even water availability and distribution. 	<ul style="list-style-type: none"> • Higher initial and ongoing costs. • Need specialised machinery to lay both trickle and plastic. • Need specialised machinery to plant either container-grown seedlings or plant seed directly through holes made in the plastic.



Using these products
Table 7

This section page 14

- Mulches reduce fruit losses from soil-borne diseases, particularly in ground crops.
- Soil temperatures are increased and provide a better growing environment cool weather.
- Weed growth in the plant row is restricted.
- Reflective mulches will repel aphids.
- Ensures water is applied to the root area of the plant.
- Plastic mulches improve the lateral spread of water in some soils.
- Poorer quality water can be used with trickle irrigation.
- Supplementary fertiliser applications can be made accurately with trickle irrigation.
- The plastic may harbour rodents or soil insects, which can destroy seedlings or the plastic tubing.
- The environment under the plastic can favour the build-up of nematodes and in other soil-borne pests.
- The plastic and trickle tubing require lifting and disposal after use.

Plastic mulches come in various thicknesses, widths and colour. The common practice is to use white or grey/blue plastic during hotter periods to reduce soil temperatures while black plastic is used when temperatures are lower. A silver reflective plastic mulch which helps to minimise aphid build-up can be used to reduce mosaic infection.

Plastic mulch is usually purchased as 1000 m rolls. Width varies from 900 mm to 1200 mm and thickness from 25 to 35 microns. Table 12 shows the length of plastic mulch and trickle tubing required per hectare at various row spacings.

Table 12. Length of plastic and trickle tubing required per hectare

Distance between rows	Metres of plastic mulch and trickle tubing per hectare
1.2 m	8333
1.5 m	6667

Trickle tubing

The capacity, quality and price of trickle tubing varies depending on the type and manufacturer. Cheaper, thinner tubing is commonly used and discarded after the crop has been harvested. Thicker, more expensive tubing is used if crickets have chewed the tape. This tubing can be re-used if you are careful retrieving it.

Emitters are usually spaced 20 or 30 cm apart. The closer spacing is used where lateral movement of water is poor, for example sandy soils, and the wider spacing where lateral water movement is good, for example heavier clay soil types.

Lay trickle tubing with the holes up, to prevent blockages from sediments. It is laid between the pair of rows on the bed or about 10 cm to one side of single rows.

Form beds and lay mulch

Lay plastic mulch and trickle irrigation on raised beds. In shallow soil, form rows into low broad hills (15 cm high and about 60 cm wide) to increase soil depth, improve drainage and reduce the risk of waterlogging. Narrow, steep hills dryout too quickly and stress the plants.



Cleaning trickle tubing
Section 4 page 59

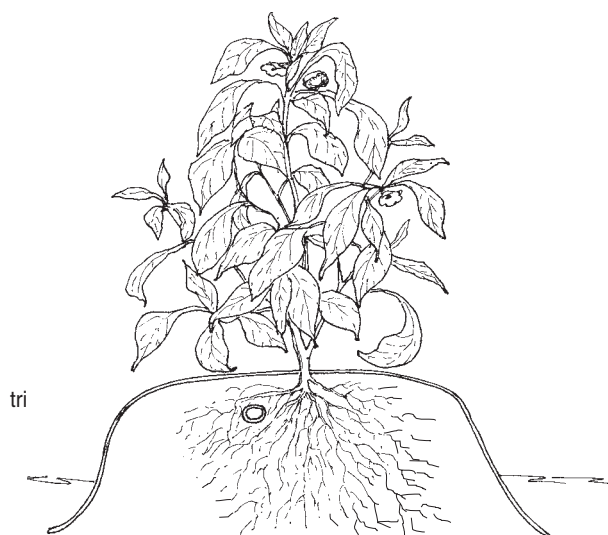

Figure 8. Plastic mulch over a well formed bed; note trickle tube

Forming beds, laying the plastic mulch and installing trickle tubing is done in the one operation by a specially designed machine. Some machines also mark out rows and apply and incorporate pre-plant fertiliser at the same time. The trickle tubing can be laid on top of the soil directly under the plastic but is best buried about 5 cm deep. This helps prevent any 'snaking', so the trickle tubing maintains its position beside the plants.

Beds can be formed and mulch laid several weeks or immediately before planting. Laying mulch well before planting ensures that the beds are ready. The crop can be planted even if wet weather would otherwise have interrupted land preparation. In hot weather, if the polythene mulch is laid for some time before planting, fewer weeds may grow through the planting hole after planting.

Look after transplants until planting

Hardening off

The greatest cause of seedling losses is planting out 'soft' plants that have not been hardened off as they are unable to survive the sudden change from the growing house to the field. Too much protection for too long, particularly if plants are crowded together in small cells and over fertilised, will result in soft spindly plants.

In north Queensland seedlings are not generally grown under cover so hardening off is not as important.

One week before planting out stop nutrient foliar sprays and reduce watering. Where plants were grown under cover, either remove the cover over the trays or move trays into the open to prepare the plants for field conditions.

Trace elements

Apply trace elements if deficiencies developed in previous crops or

where soil analysis results suggest a possible deficiency. Spray to wet the leaves only, not to have runoff, to prevent leaf burn. Do not apply foliar nutrients with pesticide sprays. The addition of urea at 50 g/10 L of water will increase the leaf's absorption of trace elements.

To prevent molybdenum deficiency spray seedlings with sodium molybdate (6 g/10 L) or another source of molybdenum. For zinc deficiency, apply zinc sulphate heptahydrate (10 g/10 L) before planting. Further sprays may be required in the field.

Treatment before planting out

A nutrient drench immediately before planting out will help plant establishment. A protectant fungicide spray is recommended immediately before planting. A copper spray will protect plants against bacterial spot. Apply an insecticide if insect pests are present.

Plant

Discard any weak or diseased plants as they are unlikely to establish or produce well in the field. If pesticides have been applied close to planting out, wear gloves when planting.

Seedlings should pull easily from the trays as squeezing to pull the plant out can damage stems and increase the risk of fungal infections. If plants are too tight in the tray, the mix may be too dry. Loosen plants by tapping the bottom of the tray or dropping it a few centimetres onto a hard flat surface.

Seedlings are transplanted by hand or machine into moist well prepared soil.

For best results, if using a cup transplanter, seedlings should be more than 12 cm high. Seedling height is less important if using waterwheel planters. If plants are too small they may be damaged by being trapped under the plastic in windy weather. Figure 9 shows a seedling ready for transplanting.

Losses can be high if planting in hot windy weather or if plants are left unirrigated. Apply a good watering immediately after planting out.

Take the following precautions:

- keep transplants moist while awaiting planting;
- make sure the potting mix is just covered with soil;
- follow the planter to make sure transplants are correctly planted;
- irrigate the plants immediately after transplanting to firm the soil around the plant;
- if cutworms or false wireworms are known to cause problems, spray the soil at the base of the plants before nightfall on the day you plant. Use a chemical from the *Problem solver handy guide*.

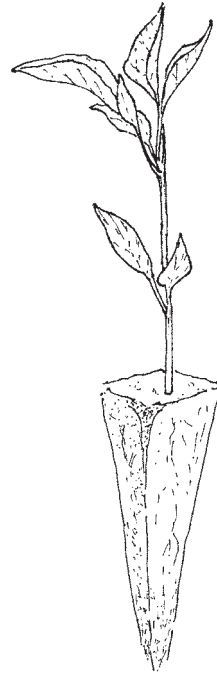

Figure 9. A seedling ready for planting



Planting to early fruit set

This stage usually takes four to seven weeks. There are eight important things to manage during this stage.



Crop production
handy guide

Monitor soil moisture and irrigate	24
Manage pests and diseases	27
Control weeds	30
Trellising	31
Pruning	31
Control frost	32
Pollination	32
Manage plant nutrition	32



Figure 10. The frame indicates planting to early fruit set stages

Monitor soil moisture and irrigate

Irrigating from planting to establishment (to three weeks)

Irrigate immediately after planting and keep soil moist but not over wet until plants are well established. A frequent cause of poor establishment is insufficient or infrequent irrigation after transplanting. If the

Planting to early
fruit set

potting mix is not kept moist it will shrink, forming a small air layer between the mix and the soil. The roots cannot cross this air barrier so the plants will not grow. The mix is hard to re-wet once dried out so keep it moist until the roots are well established in the soil.

Apply small quantities frequently until plants have sufficient root volume for tensiometers to be effective. Do not over water as this will cause nutrient leaching and waterlogging around the young transplants.

If using overhead irrigation it should be applied in the morning so that plant foliage is dry by evening. Overhead irrigation is not recommended because it encourages the spread of bacterial diseases.

Water quality

Recheck the quality of your irrigation water to make sure it is still suitable for irrigating capsicums. Reduced yields can be expected if the water conductivity (salt content) is above 1200 microSiemens per centimetre ($\mu\text{S}/\text{cm}$); if above 2000 $\mu\text{S}/\text{cm}$, blossom-end rot is likely.

Irrigating once plants are established

Good irrigation practices are essential to produce a good yield of high quality capsicums. Crops grown without irrigation are generally poor and not economically viable.

Do not over water, especially when the soil is cold from June to early August. If using an overhead system, irrigate in the morning, so that plant foliage is dry by evening. This will reduce the risk of spread of diseases.

Irrigation timing

Critical times are flowering, fruit set and fruit fill. Moisture stress can lead to flower drop and severe blossom-end rot. Less frequent but increasing quantities of water are required as plants grow, particularly if temperatures are increasing, for example, a spring crop.

Water quantity

The amount of water required depends on the type of irrigation used, the locality and the soil type. As a general rule capsicums require 30 to 40 mm of irrigation per week. Sandy soils have a much lower water-holding capacity than clay-based soils so need smaller, more frequent applications of water.

Irrigation scheduling

The decision on when to irrigate has often been made by feeling the soil, looking at the plants or watering at a pre-determined time interval. It is better to schedule irrigation with much greater precision by using instruments such as the Enviroscan and tensiometers.

The **Enviroscan** is an expensive piece of equipment, which is gener-



Irrigation
Section 4 page 49

Planting to early fruit set

ally used only by crop consultants and large growers. It uses electrical induction to give a complete profile of moisture conditions throughout the root zone. By using this information, you can determine the daily water use and time to the next irrigation.

Tensiometers are comparatively cheap and effective instruments for irrigation scheduling. They show changes in soil moisture, so indicating the actual needs of the crop.

Depending on soil variability select at least two sites per 5 ha and install two tensiometers per site. Place the tip of the shallow tensiometer in the root zone about 15 to 20 cm deep and the other, the deep tensiometer, just below the main root zone at about 45 cm deep. Place the tensiometers midway between plants in the row. Figure 11 shows the correct placement for tensiometers. The shallow tnsiometer indicates when to irrigate, while the deep tensiometer indicates how much water to apply.

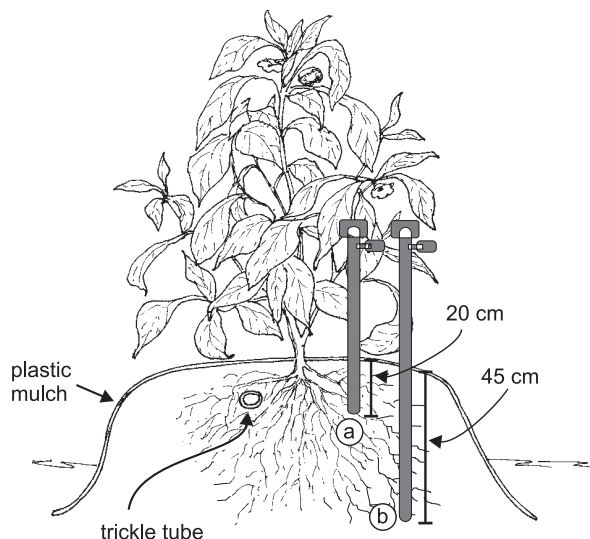

Figure 11. Tensiometers in place, (a) in root zone and (b) below main roots

Once tensiometers are installed, read the gauge to determine when to water. Read tensiometers between sunrise and 8 a.m. because at that time there is little movement of water in the soil or plants and they are almost in equilibrium. Errors caused by heating of the gauge or water column are also avoided.

It is a good idea to plot the daily readings on a chart. The chart lines show what has happened in the past and, by extending them, you can anticipate what will happen over the next few days. Apply irrigation at different readings depending on soil type and stage of growth. Table 13 is a guide to the optimum range for this stage.

Table 13. Optimum range for shallow tensiometer readings at different growth stages

Soil type	Tensiometer reading	
	Establishment	Up to early fruit set
Sandy loams	10 – 25	10 – 25
Clay soils	10 – 30	15 – 30

Planting to early
fruit set

more info



Problem solver
Section 5

Manage pests and diseases

Serious pests and diseases are likely at some stage in the crop and can cause major and even total crop losses. Good management of pests and diseases includes monitoring, timely spray applications and using an integrated pest management (IPM) approach.

Problem identification

Correct identification is the first step to control. Is the problem caused by an insect, mite, nematode, fungus, bacteria, or virus, or is it a nutritional or physiological problem? The treatment would be different in each case. To manage these problems, learn as much as possible about the pests and diseases and their recommended management.

Insect and mite pests

Check your crop regularly during the first few weeks for cutworms and wireworm damage. Cutworms chew plants off just above ground level. They curl up in the soil at the base of the plant during the day, and can be found by scratching around the base of plants. False wireworms will also chew the plant stem below ground level. If cutworms and false wireworms are known to cause problems, spray to control them before nightfall on the day you plant.

Other pests at this stage include aphids, eggfruit caterpillar, green vegetable bug, heliothis grubs, jassids, potato tuber moth (leafminer), Rutherglen bugs, silverleaf whitefly, thrips, tomato russet mites and twospotted mites.

To control these pests choose an insecticide that controls the range of insects you have found in the crop. If you use overhead watering, spray late in the afternoon when the plants are dry. Use an appropriate chemical from the *Problem solver handy guide*.

Diseases

The main disease problems at this stage are bacterial spot, bacterial wilt, mosaic (potato virus Y), sclerotium base rot, sudden wilt, tomato spotted wilt virus (TSWV) and, in north Queensland, powdery mildew. Sclerotinia rot and bacterial canker can also occur at this stage. Check your crop regularly for these diseases.

Except for sclerotinia rot they are more common after hot wet weather, so present or imminent weather conditions will influence your control decisions. Choose a chemical that will control the range of diseases you can expect in your crop. Spray with one of the chemicals in the *Problem solver handy guide*.

Suggested spray schedule

Chemical application should be based on pest monitoring, however, a regular spray schedule is often used to prevent development of serious pest and disease problems, particularly for diseases for which there

a key issue



Pest and disease
management
Section 4 pages 77, 84

Planting to early
fruit set

more info



Problem solver
handy guide



a key issue



Calibrating a boom spray
Section 4 page 87

are only protectant sprays. Table 14 shows a possible spray schedule, however, there are several other chemicals available.

Table 14. A suggested spray schedule for capsicums

Pest or disease	Chemical	Frequency	Comments
Green peach aphids and grubs	methamidophos	as required	Controls a range of other insects.
Most leaf spot diseases	copper	7 – 10 days	Spray more often in showery conditions.
Powdery mildew	sulphur	as required	More common in north Queensland.

Add another insecticide or miticide as required.

Selecting chemicals

Use the most effective chemical for the particular problem. Chemicals are either protectant or curative, and systemic or non-systemic.

Protectant chemicals are usually not systemic in the plant and will not eradicate a pest. They provide a protective cover, which prevents the pest from getting established, so good coverage is essential. Eradicant chemicals will control a pest that is already established.

Systemic chemicals penetrate the leaf or roots into the sap stream and are transported through the plant with the sap stream. They will control a pest that is already established. Although coverage is not as important with systemic chemicals, good coverage will give best results.

Only chemicals registered for control of the particular pest on your crop can be used legally.

Application of chemicals

Most chemicals are applied as sprays. The results from spraying will only be as good as the coverage you achieve with your equipment. An engine-powered sprayer is recommended. These include hydraulic sprayers (hand-held or tractor-mounted boom), air-blast machines and controlled droplet applicators. Hand-operated knapsack sprayers are not capable of sufficient coverage.

Hydraulic sprayers are the most common and it is important that they are set to provide maximum coverage of the crop. Aerial spraying is also used for large areas or where tractor access is restricted due to wet weather. Chemicals can also be applied as dusts or injections through trickle irrigation systems.

Good pest control is only achieved through good coverage of the plant, particularly for protectant chemicals. The ideal droplet size for insecticides and fungicides ranges from 40 to 100 microns. Spray equipment must be calibrated regularly to achieve this and nozzles changed when they start to wear. This may be every 10 hours when wettable powders (for example copper) are used through brass jets.

*Planting to early
fruit set*

Do not apply herbicides with your pest and disease sprayer. This avoids the risk of herbicide residues in the sprayer damaging the crop. For more detail on safe and efficient spray application refer to the DPI publication *Pesticide application manual*.

Care with chemicals

Agricultural chemicals should always be handled responsibly and with care. They are most dangerous when undiluted. Protective clothing, including boots, overalls, gloves and a mask, should be worn at all times. Use according to directions only. Avoid spraying if spray is likely to drift off the crop. Dispose of waste chemicals and containers thoughtfully to protect the environment. Only use chemicals registered for use on your crop.

Bird and animal pests

Ducks, hares, rabbits, wallabies or kangaroos may chew off plants. Termites may be a problem in new ground. If hares, rabbits, wallabies and kangaroos are a problem, build a netting or electric fence around the perimeter of the block. A trail of dried blood around the block may work for a few days. Wallabies and kangaroos are protected and problems with these animals should be referred to the Queensland National Parks and Wildlife Service (QNPWS). Hares and rabbits are not protected. Baiting best controls mice and rats. Figure 12 is a diagram of an electric fence to keep hares and rabbits out of crops.

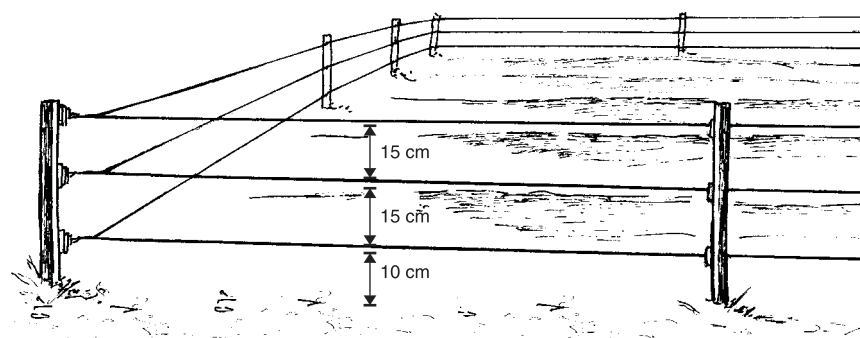

Figure 12. A diagram of an electric fence to exclude hares and rabbits from crops

Not all birds in the crop will cause damage. Most will be eating insects, so are beneficial. Most native birds are protected and cannot be trapped or destroyed without a permit from the QNPWS. A QNPWS officer will only issue a permit after an inspection. You must be able to show evidence of significant damage and that you have tried other deterrent methods. Scare guns and suspended hawk kites are used but are not highly effective.

Planting to early
fruit set

Control weeds

Unmulched crops

In unmulched crops weeds can be controlled by hilling. This involves making a small ridge of soil along the planted row after the seedlings are established (10 to 14 days after transplanting). Hilling controls weeds along the row and supports the plants. Take care to prevent root damage.

Rows are usually hilled as part of the normal interrow cultivation. This starts about 10 to 14 days after transplanting and continues until about six weeks before harvest, when mechanical access through the crop becomes difficult.

The knockdown herbicide, fluazifop-P (Fusilade) will only control grasses, not broadleaved weeds, and can be sprayed over the capsicum plants. It should not have any effect on following crops. Paraquat, diquat and glyphosate are knockdown herbicides, which must be directed between the rows. See Table 15 for registered chemicals.

Table 15. Herbicides for controlling weeds in a capsicum crop

Chemical	Trade name	Rate per		Comments
		ha	100 L	
These chemicals are for use between the rows				
diquat	Reglone	1.4 – 4 L + Agral		Shield the nozzle to stop drift. Use where broadleaf weeds predominate. See label for more details. 0 days withholding period.
glyphosate-ipa	Squadron	2.5 – 4 L	400 – 600 mL	Shield the nozzle to stop drift onto plants or plastic. Direct the spray so that it does not touch the crop. Do not spray weeds under poor growing conditions, when covered with soil or dust, or wilting due to dry conditions. See label for more details.
paraquat	Gramoxone	1.2 – 2.4 L	200 – 400 mL	Use shielded nozzles. Direct the spray so that it does not touch the crop. Apply after crop seedlings have emerged or when transplanted crops are established. Reglone can be added at 750 mL to 1.5 L/ha. See label for more details. 0 days withholding period.
	Maxitop			
	Uniquat			
paraquat + diquat	Nuquat	1.5 – 3 L	250 – 500 mL	Shield the nozzle to stop drift. Spray when weeds are growing vigorously and not covered with soil or dust, or wilting due to dry conditions. See label for more details. 0 days withholding period.
	Paraquat	1.5 – 2 L		
paraquat + diquat	Spray.Seed	2.4 – 3.2 L	240 – 320 mL	Shield the nozzle to stop drift. Spray when weeds are growing vigorously and not covered with soil or dust, or wilting due to dry conditions. See label for more details. 0 days withholding period.
	Tryquat	3 – 4 L	300 – 400 mL	
This chemical controls grasses only				
fluazifop	Fusilade	500 mL – 1 L	12.5 – 100 mL per 10 L (spot)	Apply when weeds are growing actively at the 3 to 5 leaf stage before tillering starts. Thoroughly wet target weeds. See label for more details. 77-day withholding period.

Planting to early
fruit set

Mulched crops

Some weeds may grow up through the planting holes around the plants. They must be carefully removed by hand so the plant roots are not disturbed.

The space between rows can be kept weed-free by using a knockdown herbicide from Table 15. Apply these sprays at low pressure using shielded fan nozzles to prevent drift onto the crop.

Trellising

Growers will sometimes trellis a crop to support plants to reduce wind damage, keep fruit off the ground and reduce sunburn. A double wire or twine trellis is used.

Smaller stakes (50 x 30 mm) are driven in 30 cm deep every 5 m along the row. Pairs of wires (3.15 mm or 12 gauge) are then placed on either side of the crop and lifted and tied to the posts and stakes, giving the parallel wire arrangement. Normally one or two sets of wires are used. The first pair of wires is positioned 20 cm above the ground. Further sets of wires are placed at 20 to 30 cm intervals up the crop.

Erect trellises before lodging or just after the last cultivation on un-mulched crops. Figure 13 shows the design of a wire trellis sometimes used in Queensland.

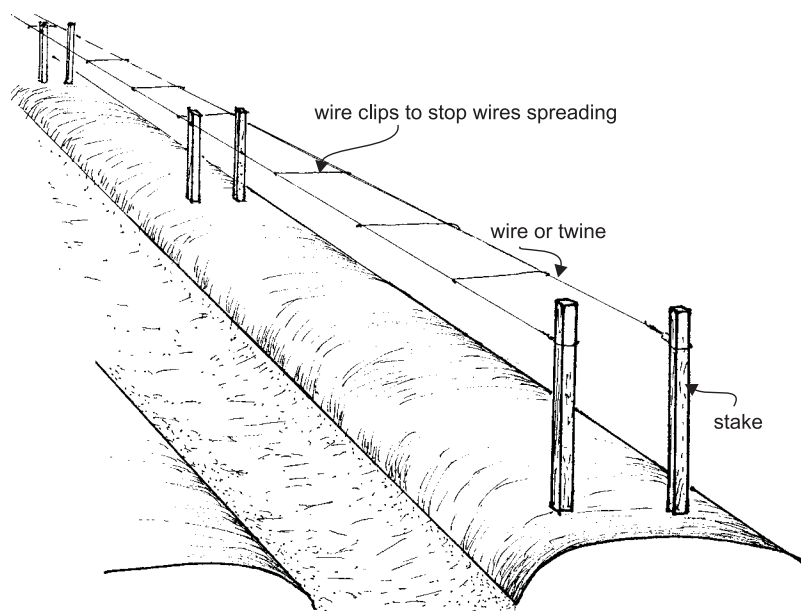

Figure 13. The structure of one type of capsicum trellis

Pruning

Pruning is rarely practised commercially, however, it may be necessary after wind damage. Apply a protectant fungicide spray after pruning.

Planting to early
fruit set

Control frost

Capsicum plants are sensitive to frosts and should not be planted in frosty locations (lower parts of the block) because temperatures below freezing point (0°C) will damage plants. Provided the plants are kept covered by a thin film of water they will not be damaged, even if the air temperature falls below 0°C. This procedure is only possible if you have overhead irrigation equipment.

Protect the plants by continual overhead watering while temperatures stay below 0°C. Your overhead watering system should put out about 2 mm of water per hour with sprinklers rotating at least once every minute. If you have an electric pump, connect it via a thermostat to a temperature sensor in the crop. Set the thermostat to start the pump when the air temperature falls to 1°C. Alternatively, you can have the temperature sensor connected to an alarm, which alerts you to go and start the pump.

Continue the overhead watering until the air temperature rises above 0°C and all the ice formed on the plants and fruit has melted.

Seek professional advice from your local electricity authority on designing and operating this equipment.

Pollination

Capsicums are self-pollinated; they do not require insects to set fruit.

Manage plant nutrition

The application of fertiliser every few weeks without knowing whether the plants need it wastes money and is environmentally irresponsible. Take the guesswork out of fertiliser applications by monitoring plant nutrient levels. If soil or sap tests are not available Table 16 is a guide to fertilising at this stage. Up to 60% of the nitrogen is usually applied before fruit set.

Table 16. A guide to fertiliser application up to early fruit set

Weeks from planting	Fertiliser	Rate (kg/ha)	Comments
Weeks 2 and 4	Calcium nitrate	20	Do not mix calcium based products with phosphorus based products.
	Mono ammonium phosphate	15	
Week 5 (or early fruit set)	Calcium nitrate	30	
	Ammonium nitrate	10	

If there is leaching rain, 40 kg/ha of urea should be applied to the crop after each significant fall to maintain adequate early vegetative growth up to first fruit set. More rain is needed to leach fertiliser out of the



Nutrition
Section 4 page 37

Planting to early fruit set

root zone of plastic-mulched crops than on non-mulched crops.

Plant nutrient monitoring

Leaf testing is a benchmarking tool that has little direct relevance to the current crop. Its value is in judging the effectiveness of the fertilising schedule used in this crop and how it may be improved for the next crop. Optimum values are given in Table 17. Use the results of soil and leaf testing to refine the fertiliser schedule for the next crop.

Do a leaf analysis at early fruiting. Buy a tissue sampling kit from your farm supply outlet and follow its instructions. The laboratory analysing your sample will interpret your results and advise what nutrients are needed. The optimum levels for the youngest fully mature leaf taken when the first fruit mature are shown in Table 17.

Table 17. Optimum leaf nutrient levels (based on dry weight)

Nutrient	Normal level
Nitrogen (N)	3.0 – 5.0%
Phosphorus (P)	0.3 – 0.6%
Potassium (K)	3.0 – 5.5%
Calcium (Ca)	1.0 – 3.5%
Magnesium (Mg)	0.25 – 1.2%
Sodium (Na)	0 – 0.3%
Chloride (Cl)	0 – 1.6%
Copper (Cu)	10 – 200 ppm
Zinc (Zn)	20 – 100 ppm
Manganese (Mn)	26 – 300 ppm
Iron (Fe)	60 – 300 ppm
Boron (B)	30 – 100 ppm
Molybdenum (Mo)	0.5 – 2 ppm

Source: Weir and Cresswell, NSW Agriculture, 1993.

Sap testing is a means of rapidly assessing a plant’s nutrient status during crop growth. This test has a 24 hour turn-around time. It can be used to highlight deficiencies of any essential element or to monitor the nitrate and potassium levels during the crop cycle. It allows growers to manage the crop more precisely or to correct any nutrient problems before yield or fruit quality is affected.

The test involves collecting leaf stalks (petioles) and the mid-rib of the youngest fully expanded leaves, usually the fourth or fifth leaf back from the growing point, extracting sap with a garlic press, and analysing its nutrient content. Sap testing may start at early budding and continue through harvesting for crops harvested over a long period. Figure 14 shows which leaf to collect.

You can do the tests yourself, but we recommend you use a commercial sap testing service for the tests and advice on the results.

Sap testing for nitrogen, phosphorus, potassium, calcium, magnesium and zinc should be done at least monthly and ideally every two weeks. Other nutrients should be tested at least three times during the season.

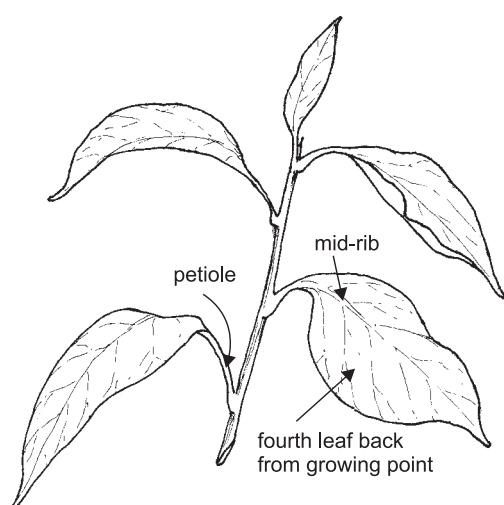

Figure 14. For sap tests, collect the youngest fully expanded leaf from the growing point

*Planting to early
fruit set*

Nitrogen and potassium are the two most easily managed and influential nutrients in capsicums. Table 18 indicates the optimum range for these nutrients.

Table 18. Optimum sap levels for nitrogen and potassium

Nutrient	Level in milligrams per kilogram (mg/kg, ppm)			
	Bud development	Early flowering	Late flowering	Fruit set
Nitrate	4 500	5 000	4 000	3 000
Potassium	5 000	5 000	5 000	5 000

Other major elements

Other elements may also be deficient in some soils at times and these may need to be corrected.

Calcium. Calcium deficiency is associated with blossom-end rot of fruit and has also been implicated with the fruit-spotting condition called Yolo spot or green spotting. For reasons not well understood, plants can be deficient in soils with adequate levels of calcium present. Uneven soil moisture and poor quality water increase the severity of the problem. Foliar sprays of calcium nitrate (CaNO_3) at 200 g/100 L, applied when fruit are very young, may reduce blossom-end rot and improve fruit quality.

Magnesium. Magnesium can be deficient, particularly in high rainfall areas and where soils are fairly acid, if preplant soil treatment with dolomite is inadequate or where high rates of potassium nitrate are used through trickle irrigation. Yellow mottling between the veins of older leaves is a symptom of deficiency. Foliar sprays of magnesium sulphate (2 kg/100 L) are preferable to correct deficiencies. Magnesium sulphate can be applied through the irrigation system (20 to 25 kg/ha), but calcium in irrigation water may react with sulphates and cause precipitation in trickle tubing.

Trace elements

Apply trace elements if deficiencies have developed in previous crops or where soil analysis results suggest a possible deficiency. Do not exceed the rates suggested here. The addition of urea at 500 g/100 L of water will increase the leaf's absorption of trace elements. Only spray to wet the leaves, not to have runoff, otherwise leaves may burn. Apply foliar nutrients separately, not combined with pesticide sprays.

Boron. Boron deficiency, which causes fine cracking of the skin surface, is more likely in alkaline soils. Apply Solubor (200 g/100 L) about three weeks after transplanting and at early fruit set. Do not mix with zinc sulphate heptahydrate.

Molybdenum. Molybdenum deficiency is more common in soils below a pH of 6.0. Older leaves become mottled and may curl in and die back from the tip. Apply as sodium molybdate (60 g/100 L) or another molybdenum source about three weeks after transplanting.

*Planting to early
fruit set*

Zinc. The availability of zinc decreases at pH levels above 7.0 and below 5.0. High phosphorus levels and wet or cold conditions can induce zinc deficiency. Leaves yellow between the veins and may be small, resulting in the term 'little leaf' for zinc deficiency. If a zinc deficiency becomes apparent, apply zinc sulphate heptahydrate at 100 g/100 L or zinc chelates.

Foliar fertilisers

Foliar fertilisers contain soluble nutrients, which are sprayed on the crop and absorbed through the leaves. They may be urea or potassium nitrate dissolved in water, specific trace elements or a 'shotgun' mixture of many major and trace elements.

As plants absorb nutrients mainly through the root system, foliar fertilisers should not be used to replace soil applications. However, where specific trace element deficiencies have been identified, or disease, nematodes or waterlogging have rendered the roots ineffective, foliar fertilisers may help the plants survive until new roots develop and can again support the plant.



Early fruit set to first harvest

This stage usually takes five to eight weeks. There are four important things to manage during this stage.

Monitor soil moisture and irrigate	36
Manage pests and diseases	37
Control weeds	37
Monitor plant nutrients and fertilise	37
Manage irrigation.....	39



Figure 15. The frame indicates early fruit set to first harvest stages. An understanding of the plant’s growth cycle will help with crop management. Refer to the Crop production handy guide.

Monitor soil moisture and irrigate

An irrigation scheduling technique such as tensiometers or Enviroscan is essential for good irrigation management. At this stage the crop should not be allowed to dry out. Table 19 is a guide to the optimum range for tensiometers from early fruit set to the first harvest.

Table 19. Optimum range for tensiometers from early fruit set to first harvest

Soil type	Tensiometer reading
Sandy loams	10 – 25
Clay soils	10 – 30

Early fruit set to first harvest

Manage pests and diseases

Insect and mite pests

Monitor plants regularly for heliothis, eggfruit caterpillar, fruit fly, aphids, mites, silverleaf whitefly and Atherigona. Spray with an appropriate chemical from the *Problem solver handy guide*.

Diseases

Monitor for the diseases bacterial spot, bacterial wilt, mosaic (potato virus Y), sclerotium base rot, sudden wilt, tomato spotted wilt virus, grey mould (*Botrytis*), powdery mildew and sclerotinia rot during this stage of the capsicum crop cycle. Spray with an appropriate chemical from the *Problem solver handy guide*.



Weed control
This section page 30

Control weeds

Control weeds between the rows and in the rows of unmulched crops.

Monitor plant nutrients and fertilise

Continue to monitor nutrient levels using sap tests.

The fertiliser schedule used should be based on the results of soil, leaf and sap tests. If these are unavailable, use the figures in Table 20 as a guide. Table 20 indicates the optimum range for nitrogen and potassium during this stage of the crop.

Table 20. Optimum sap levels for nitrogen and potassium

Nutrient	Level in milligrams per kilogram (mg/kg, ppm)
	Early fruit set to first harvest
Nitrate	2 000 – 2 500
Potassium	5 000

Fertilising through irrigation water (fertigation)

If soil or plant test results are not available the fertiliser schedule suggested in Table 21 could be used.

Table 21. A guide to fertiliser application through trickle irrigation

Weeks from planting	Fertiliser	Rate (kg/ha)
Week 5 (or early fruit set)	Calcium nitrate	30
	Ammonium nitrate	10
Weeks 6 – 11 (up to first harvest)	Calcium nitrate	30
	Ammonium nitrate	10
	Potassium nitrate	20

Fertigation has advantages over manual application of solid fertilisers because it uses less labour. With a trickle system fertilisers can be applied more regularly and closer to the roots. Before fertigating get a water-testing laboratory to analyse your irrigation water.

Early fruit set to first harvest

With fertigation, fertiliser is dissolved in water in a drum or tank and sucked or injected through the watering system. Fertilisers used (Table 22) must be highly soluble to avoid damaging the pump and blocking pipes. There is also a range of soluble commercial fertiliser blends.

Table 22. Fertilisers that can be dissolved in water for fertigation

Fertiliser	Main elements supplied	% of elements
Urea	Nitrogen	46% N
Calcium nitrate	Calcium, nitrogen	18.8% Ca, 15.5% N
Ammonium nitrate	Nitrogen	34% N
Potassium nitrate	Potassium, nitrogen	38.3% K, 13 % N
Potassium chloride	Potassium	50% K, 50% Cl
MAP (mono ammonium phosphate, technical grade)	Nitrogen, phosphorus	12% N, 26.6% P
MKP (mono potassium phosphate)	Potassium, phosphorus	28.6% K, 22.8% P

Note: Overuse of potassium (K) and calcium (Ca) based fertilisers can induce magnesium (Mg) deficiency in soils low in magnesium or with low cation exchange, that is less than 2 milli-equivalents per 100 g (meq/100 g) of soil on your soil test. After every second application of potassium or calcium nitrate, apply 15 to 20 kg/ha of magnesium sulphate (MgSO₄) to soils low in magnesium.

Side dressing overhead or furrow irrigated crops

The fertilisers and rates in Table 23 may be used if soil or plant test results are not available. The quantities per 20 m of bed are the same whether rows are single or double spaced. Drill into the irrigation furrow before watering for furrow irrigation. Drill or spread if using overhead irrigation.

Start fertiliser application three to four weeks after transplanting and repeat every three to four weeks until about two weeks before first harvest. For crops harvested over many weeks, for example chillies, further applications at half the rate in Table 23 may need to be applied.

Table 23. A guide to side dressing fertilisers and rates

Fertiliser	Rate per	
	kg/ha	g/20 m of bed
Urea	100 kg	300 g
Or		
Ammonium nitrate	150 kg	450 g
Alternated with		
15:4:11 mixture or similar	250 kg	750 g



During harvest

This stage usually takes one to six weeks, however, chillies and some capsicum varieties may be harvested longer. There are six important things to manage during this stage.



Crop production
handy guide

Manage pests, diseases and disorders	40
Control weeds	41
Manage nutrition	41
Harvesting	41
Disposal of reject fruit in the field.....	42
Packing shed operations.....	43



Figure 16. The frame shows the capsicum plant during harvest

Manage irrigation

Maintain even soil moisture during harvest. Table 24 is a guide to the optimum range of tensiometer readings during harvest.

Table 24. Optimum range for tensiometers during harvest

Soil type	Tensiometer reading
Sandy loams	10 – 25
Clay soils	10 – 30

During
harvest

more info



Problem solver
handy guide

Manage pests, diseases and disorders

Insect and mite pests

Monitor regularly for heliothis, eggfruit caterpillar, mites, aphids, fruit fly, silverleaf whitefly and *Atherigona*. Refer to the *Problem solver handy guide* for products registered for use on capsicums. Be aware of the withholding period (WHP) of the products you use.

Diseases

Monitor for the diseases anthracnose, bacterial spot, bacterial wilt, grey mould (*Botrytis*), mosaic (potato virus Y), powdery mildew, sclerotium base rot, sclerotinia rot and tomato spotted wilt virus (TSWV) during this stage of the capsicum crop cycle. Refer to the *Problem solver handy guide* for products registered for use on capsicums. Be aware of the withholding period (WHP) of the products you use.

Disorders

Several disorders become obvious in capsicums at harvest.

Blossom-end rot. This shows as a light brown lesion, usually on the sides of the fruit, that turns darker then black. Blossom-end rot is a calcium deficiency in the fruit as a result of water stress. It is most common in dry, windy weather and when poor quality water is used, or the soil has a high salt content.

Frost damage. Affected fruit assume a translucent bleached appearance, usually only on the exposed side. In severe cases it leads to fruit breakdown. On less severely affected fruit, shallow surface pitting occurs without a noticeable loss of fruit integrity.

Misshapen and deformed fruit. This is a non-pathological disorder associated with poor pollination leading to growth differences between the fruit segments. The normally blocky shape of the fruit is lost and fruit are smaller. The affected fruit have few seeds.

Extremes of high and low temperature can lead to this problem. There is little that can be done apart from changing the production window to a more suitable time of the year.

Sunburn damage. Sunburn is often associated with other stress factors such as insufficient soil moisture or a wilt disease. It occurs when the bush is opened up during harvesting and the foliage is not returned to cover the remaining fruit at the completion of harvesting. It is more prevalent in warm weather.

Large yellow areas form on the exposed fruit surface. At first these areas are firm but later may decay from secondary fungi and bacteria. Bleaching, causing a silvery sheen on the underside of newly exposed leaves, also occurs.

Yolo spot. Yolo spot appears as slightly sunken spots on fruit and firm brown tissue through the flesh under the spot. The cause is not known but it appears to be associated with calcium imbalance in susceptible varieties.

more info



Pictures of capsicum
disorders
Problem solver

During
harvest

Bird and animal pests

Birds (especially crows), rats, mice and wild pigs can damage fruit. Not all birds seen in the crop will be damaging fruit. Most will be eating insects and are beneficial. Most native birds are protected and cannot be trapped or destroyed without a permit from the Queensland National Parks and Wildlife Service (QNPWS). A QNPWS officer will only issue a permit after an inspection. You must be able to show evidence of significant damage and that you have tried other deterrent methods. Scare guns and suspended hawk kites are used but are not highly effective.

Control weeds

Control weeds in the interrows to facilitate harvesting.

more info



Weed control
This section page 30

Manage nutrition

Continue to monitor nutrient levels using sap tests and apply nutrients as required. Table 25 indicates the optimum range for nitrogen and potassium during this stage of the crop. If sap tests are not available, weekly applications of 30 to 40 kg/ha of potassium nitrate could be applied during harvest.

Table 25. Optimum sap levels for nitrogen and potassium

Nutrient	Level in milligrams per kilogram (mg/kg, ppm)
	During harvest
Nitrate	1 000
Potassium	5 000

Harvesting

The market wants full green or full red fruit, not fruit in the transitional brown phase from green to red.

Picking generally starts 10 to 12 weeks after transplanting for green fruit, which coincides with the first sign of red fruit in the block. Full colour red fruit take about two to three weeks longer to develop than green fruit.

Capsicum and chilli harvest varies in frequency, depending on speed of growth. In cooler periods a harvest once a week may be all that is required. In warmer periods harvesting two to three times a week may be justified, depending on yields and crop stage. If you leave capsicum fruit to go red, yields are reduced because plants stop setting while loaded with fruit. Losses are also higher due to disorders, pests and diseases. Red fruit usually return higher prices. Chillies are usually picked red.

Assessing maturity

Fruit are harvested at the colour at which they will be marketed. Fruit

During harvest

picked at the mature stage will be firm, thick-walled and bright green. Coloured fruit should be at their full colour, for example red or yellow, not partly coloured, for example brown.

Harvesting techniques

The most widely used technique is to simply snap the fruit from the bush by hand. Cutting gives a cleaner break but is too slow.

Ensure pickers take care not to disturb the bush too much as exposed fruit and leaves may sunburn. Make pickers aware of the need for careful fruit handling because the price you receive at the market depends on the care taken in handling the fruit from harvest to sale. Take time to train and supervise your pickers. Results are always better if pickers are provided with good working conditions.

Most chillies are harvested at full colour development. Wear rubber gloves for picking chillies and do not touch your face with the gloves.

Fruit handling

Capsicum and chilli are easily damaged and this causes downgrading. Damage results in higher incidences of postharvest diseases such as bacterial soft rot and *Rhizopus* rot.

Avoid picking very early in the morning if possible, particularly under still, dewy conditions. Fruit are usually fully turgid under these conditions and very susceptible to mechanical damage from dirty or scuffed picking buckets. Clean picking containers and machinery after each use to minimise potential fruit damage. Damaged fruit are susceptible to water loss and disease infection.

Fruit are harvested into 20 L picking buckets or onto harvest booms that deliver fruit into bulk bins. Transport harvested fruit to the shed as soon as possible to minimise exposure to direct sunlight and prevent heat build-up. This heat has to be removed later in the pre-cooling room. Bulk-bins, plastic garbage bins or 20 L buckets are all used to transport capsicums from the field; 10 L buckets are used for chillies.

Harvest aids

The major advantage of picking aids is a reduction in the labour required for harvesting. Harvesting is quicker as there are no buckets to be carried to the roadways and the workload on the pickers is easier.

Disposal of reject fruit in the field

Crush fruit rejected in the field to prevent it becoming a breeding place for insects, for example fruit fly and *Atherigona*. Crushed fruit dry out quickly, minimising the likely build-up of disease problems, for example grey mould (*Botrytis*).



Fruit handling and marketing

Capsicums must be harvested, handled and marketed with care as the price you receive for your fruit depends largely on appearance and quality. There are nine important steps.

Postharvest handling	43
Cooling the fruit	44
Grading and packing	45
Packaging.....	46
Mark packages	47
Transport	48
Storage	49
Marketing	49

Packing shed operations

After harvesting and transport to the packing shed, the fruit are tipped into a hopper with a creep feed attached to the grader, where they are continually sprayed with water to remove accumulated dust and spray residues and loosen other leaf debris that may be adhered to the fruit. The fruit are then passed over a series of roller brushes, which remove remaining adhering material such as soil and leaves. A chlorine spray may be applied at this stage to prevent fruit breakdown.

The fruit then pass to a series of sorting rollers where defective fruit are removed.

Fruit are usually graded manually for size and colour by packers; larger sheds use graders that sort the fruit for size.

Postharvest handling

Capsicums cannot be coloured using ethylene gas because the fruit become an unattractive yellow to dull red and cannot be sold.

Since capsicums and chillies have only a moderate respiration rate, pre-cooling before packing is not necessary. Most growers cool after packing.



Postharvest treatments
Section 4 page 84

Chemical treatments to control postharvest rots

Chemical treatments are applied to control fruit breakdown, usually Rhizopus rot or bacterial soft rot.

Fruit to be consigned to some southern markets must receive a post-harvest treatment to control fruit fly. This treatment must be the last treatment applied.

Dispose of reject fruit

All fruit rejected in the shed during sorting should be removed as soon as possible to reduce the risk of infection of marketable fruit. This reject fruit should be disposed of quickly, preferably by burying.

Cooling the fruit

Consult a refrigeration engineer when designing a cold room. The engineer will need details of:

- maximum volume and weight of fruit;
- the time required to cool the product;
- the type of container the fruit will be packed in;
- the maximum temperature of the fruit at the time of placing in the cold room;
- the minimum temperature to which fruit will be cooled.

After packing cool fruit to between 7 and 13°C to retain freshness, reduce shrivelling from moisture loss and reduce weight loss.

There are two common ways to cool fruit.

Room cooling. Cold air is blown out into the room containing the cartons of fruit. The air returns to the cooler past the outside of the cartons, and may take up to 30 to 36 hours to cool the fruit.

Forced-air cooling. Cool air is sucked through cartons stacked with the ventilation slots aligned to allow air movement through the boxes into a central low pressure channel and plenum chamber and returned to the room via the cooling coils. Advantages of forced-air cooling are:

- faster cooling, one-sixth to one-tenth of time taken for room cooling; (Cooling rate is determined by the time requirement and cooling system capacity.)
- no condensation within cartons;
- more efficient use of power and cooling capacity.

Once cooled, cartons can be maintained at temperature by room cooling. Figure 17 shows pallets of capsicum cartons ready for forced-air cooling.

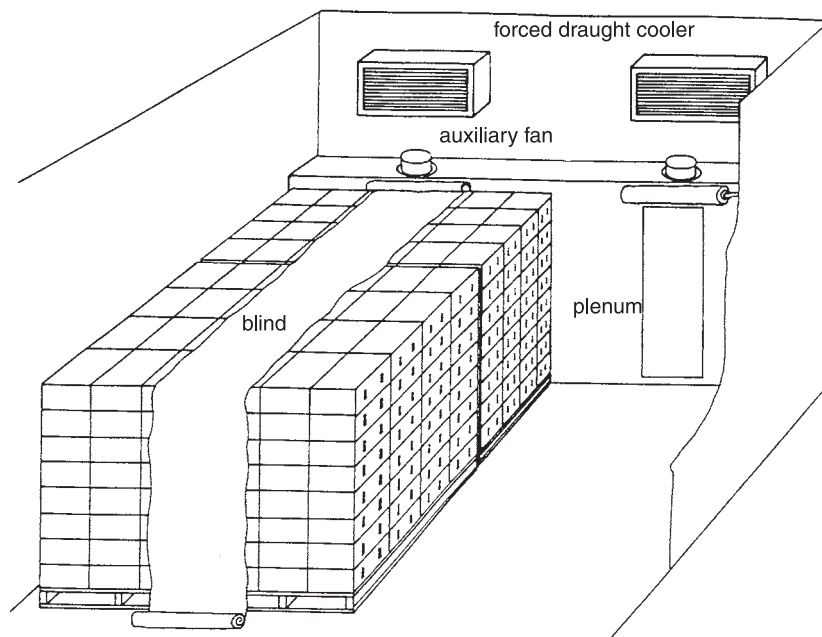

Figure 17. Cartons of fruit ready for cooling



Grading and packing

Grade fruit for size and colour. Capsicums are volume-filled or hand-packed into the containers (Figure 18). The containers may be filled by hand or automatically. Some growers pack into the lid of the carton to give fruit an even appearance when the lid is removed. The fruit must be of the one grade, size and colour. Mixed colours in the one container are not wanted on the market and will be highly discounted in price. The market requires either full green or full red capsicums, not partially coloured fruit. Most chillies are sold red.



Figure 18. Cartons of capsicums; left: volume filled; right: hand-packed

Grade standards

Grade standards are no longer legally in force for domestic markets. To meet both the agents' and consumers' expectations, capsicums should be prepared so they will arrive at the final destination in a satisfactory condition. Many of the major buyers are developing their own standards, so if you are supplying several buyers, grade to the strictest standard set.

Capsicums are graded on colour (green, turning or red) and size. Size

is measured as length and fruit are usually graded as small, medium or large, with some growers also grading to small-medium, medium-large and extra large. Grading to size gives a much more uniform appearance to the pack, making it more attractive to buyers. Table 26 is a suggested guide to size grading capsicums.

Table 26. Suggested size grades for capsicums

Size grade	Fruit length
Small	less than 80 mm
Medium	80 – 120 mm
Large	120 – 150 mm
Extra large	more than 150 mm

The following standards are a guide to what the market has come to expect:

- Fruit shall be sound, clean, and of similar varieties.
- When packed for sale, the diameter of the largest capsicum in the package shall not exceed the diameter of the smallest capsicum in the package by more than 50%.

Quality assurance for capsicums

Marketing and quality management is a vital step in capsicum production. How well you manage this, and the quality of your product, will have a big effect on whether you make a profit or loss from your production. Capsicum growers are implementing quality management systems driven by customer demand and food safety legislation.



Marketing and quality
management
Section 4 page 99

Packaging

Capsicums can be packed in several packages, the most popular being the 27 L package that holds 8 kg. The 18 L T35 that holds 4 to 7 kg (average 6 kg) of fruit, and the 40 L carton holding 12 kg of fruit, are also used.

Hot chillies are usually packed into 9 L cartons that hold 2.5 to 4 kg.

Packages may be constructed of fibreboard or polystyrene (best for hydro-cooling). The major retailers will not accept the polystyrene package, so check with your wholesaler. Various forms (glued, taped, stapled or 'selflocking') of fibreboard container are available. Containers used should be constructed to allow maximum air-flow through each end for rapid cooling.

Packages printed with your own brand and colour scheme make it easier for buyers to identify your fruit in the wholesale markets.

Price Look Up (PLU) numbers

Price Look Up (PLU) numbers are commonly used on most products sold through major retail chains and are being introduced for fruit and vegetables. These numbers assist checkout staff in identifying and

correctly pricing products. Though not of major importance for sales of standard lines, some high quality or special order capsicums may be individually marked with stickers that include a brand and a PLU number, thus allowing product differentiation at the checkout. There are many PLU numbers assigned to a range of capsicum types.

Palletising

Palletising reduces handling of individual cartons of fruit. The 9 L, 18 L, 27 L and 40 L cartons have been designed to fit on an Australian Standard Pallet. This pallet is usually stacked with 96, 84 or 56 of the 18 L, 27 L and 40 L cartons respectively. Chillies in 9 L cartons are usually stacked 144 to the pallet. All cartons are designed so that the base of 12 cartons fits neatly on the pallet.

When putting cartons onto pallets it is best to stack similar size and colour stage fruit on individual pallets to make handling in the market chain easier. This is referred to as unitising.

When loading a pallet it is most important that all cartons are fitted squarely on it and that the air vents of each layer of cartons face the same direction, to allow the maximum air flow through the stack. Pallet stacking aids assist with this operation. The stack is held together by corner stays and strapped, taped or wrapped with stretch nylon netting. The pallet can be shifted using fork lifts or pallet jacks. A pallet hire pool operates in most districts.

Mark packages

Every package of capsicums must be marked with the following legible information durably stamped, stencilled or printed on at least one end of the carton. Failure to do this may result in prosecution.

- The name and full address (including the state) of the packer or the person on whose behalf it was packed. The address must give enough detail for the person to be identified and located. A post office box number or mail service is not acceptable but can be included with the other information.
- The word capsicums or chillies or the abbreviation CAPS or CHILLI.
- The net weight or count of fruit in the package. The fruit must be weighed using approved and certified scales. There is no minimum weight that must be in the package provided that, at the time of final sale, it is not less than the net weight marked on the package. The word 'net' may be included but is not compulsory.

This information must also be placed on individual punnets, for example chillies. The minimum print height should be 2 mm for packages with a maximum dimension up to 120 mm and 2.5 mm from 120 to 230 mm. Printing on cartons should have a minimum letter height of 5 mm. Failure to correctly mark the package may result in fruit being withheld from sale until correctly marked.



Marking packages and
correct weight
Section 6 page 19

Unless pre-printed, capsicum packages will have a panel with space for you to stamp or stencil your name and address, and details of your wholesale agent. Space for the size, colour and net weight of the fruit and a traceability code is usually included for you to tick or circle the appropriate box. An example of a package end panel is shown in Figure 19.

THE CAPSICUM FARM																										
<table border="1" style="width: 100%; border-collapse: collapse;"> <thead> <tr> <th colspan="2" style="font-size: 0.8em; font-weight: bold;">SIZE</th> </tr> </thead> <tbody> <tr> <td style="font-size: 0.8em; font-weight: bold;">SMALL</td> <td style="width: 20px;"></td> </tr> <tr> <td style="font-size: 0.8em; font-weight: bold;">MEDIUM</td> <td style="text-align: center;"><input checked="" type="checkbox"/></td> </tr> <tr> <td style="font-size: 0.8em; font-weight: bold;">LARGE</td> <td></td> </tr> <tr> <td style="font-size: 0.8em; font-weight: bold;">XLARGE</td> <td></td> </tr> <tr> <td colspan="2" style="font-size: 0.8em; font-weight: bold;">REG No. IP No. Q11</td> </tr> <tr> <td colspan="2" style="font-size: 0.8em; font-weight: bold;">8 KG NET</td> </tr> </tbody> </table>	SIZE		SMALL		MEDIUM	<input checked="" type="checkbox"/>	LARGE		XLARGE		REG No. IP No. Q11		8 KG NET		<div style="display: flex; justify-content: space-between; align-items: center;"> <div style="border: 1px solid black; border-radius: 15px; width: 40px; height: 80px; margin-right: 10px;"></div> <div style="text-align: center;"> <p style="font-size: 0.8em; font-weight: bold;">GROWN & PACKED BY: THE CAPSICUM FARM WILSON ROAD BUNDABERG Q 4670</p> </div> <div style="border: 1px solid black; border-radius: 15px; width: 40px; height: 80px; margin-left: 10px;"></div> </div> <div style="text-align: center; margin-top: 20px;"> <p style="font-size: 0.8em; font-weight: bold;">CONSIGNED TO: AS PER CONSIGNMENT NOTE</p> </div>	<table border="1" style="width: 100%; border-collapse: collapse;"> <thead> <tr> <th colspan="2" style="font-size: 0.8em; font-weight: bold;">COLOUR</th> </tr> </thead> <tbody> <tr> <td style="font-size: 0.8em; font-weight: bold;">Green</td> <td style="text-align: center;"><input checked="" type="checkbox"/></td> </tr> <tr> <td style="font-size: 0.8em; font-weight: bold;">Coloured</td> <td></td> </tr> <tr> <td style="font-size: 0.8em; font-weight: bold;">Red</td> <td></td> </tr> <tr> <td colspan="2" style="font-size: 0.8em; font-weight: bold;">A B C D E F G H I K L M N O P Q R S T U V W X Y Z</td> </tr> </tbody> </table>	COLOUR		Green	<input checked="" type="checkbox"/>	Coloured		Red		A B C D E F G H I K L M N O P Q R S T U V W X Y Z	
SIZE																										
SMALL																										
MEDIUM	<input checked="" type="checkbox"/>																									
LARGE																										
XLARGE																										
REG No. IP No. Q11																										
8 KG NET																										
COLOUR																										
Green	<input checked="" type="checkbox"/>																									
Coloured																										
Red																										
A B C D E F G H I K L M N O P Q R S T U V W X Y Z																										
PRODUCE OF AUSTRALIA																										

Figure 19. End panel labelling for a carton of capsicums

Transport

Capsicums and chilli transport well in refrigerated trucks as a mixed load with tomatoes. Storage temperature for both commodities is similar. Capsicums suffer no ill effects from the ethylene evolved from tomatoes during transport, but avoid longer storage with ethylene-producing products.

Capsicum and chillies are best transported in refrigerated containers at 7 to 13°C, rather than unrefrigerated units. Refrigerated containers should contain the following equipment, which should be maintained in good working condition:

- fluming; (This directs cool delivery air evenly over the top of the load.)
- floor channels running the length of the container; (Floor channels allow return air to move back to the refrigeration unit.)
- a bulkhead around the evaporator. (This improves the movement of return air to the refrigeration unit and reduces the risk of freezing.)

Avoid stabilising sheets placed through the load. These sheets prevent air movement through the load, particularly if the cartons are not palletised.

Both rail and road transport are available to most centres. Road transport is more expensive but is quicker to its destination. Trucks can be loaded on the farm and unloaded at the market. Refrigeration systems in rail wagons and road transports are designed to maintain temperature, not to cool fruit. If warm fruit is loaded into a refriger-

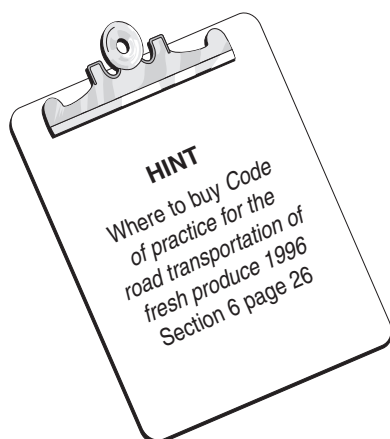

ated container there is a risk that fruit near the refrigeration unit will be chilled, because the refrigeration unit stays on longer to bring the temperature down. Print-out temperature recorders should be fitted to all refrigeration containers.

The *Code of practice for the road transportation of fresh produce 1996* is a guide to road transport.

Storage

Capsicums are not suited to long-term storage. They have a low sensitivity to ethylene and senescence can be hastened by exposure to it. Do not store capsicums for long periods with ethylene-producing fruit, for example tomatoes. Table 27 shows the conditions suitable for capsicum storage and their maximum storage life. Chilling injury is likely below 7°C.

Table 27. Conditions and maximum storage life for capsicums

Temperature	Relative humidity	Maximum storage life
7 – 13°C	90 – 95%	2 – 3 weeks

Marketing

Domestic markets

Sydney is the largest market for capsicum and chilli, followed by Brisbane and Melbourne. Melbourne consumes large quantities of chillies. Adelaide is a rapidly developing market for capsicums while both Perth and Hobart are absorbing increased quantities. Other provincial markets such as Newcastle, Townsville and Griffith all absorb significant quantities of fruit.

Capsicums are usually sold in the wholesale markets through an agent or merchant. Agents sell produce for a commission, merchants buy the produce from the grower at an agreed price, then sell it on their own account.

Wholesale agents are your source of market intelligence, so your choice of a wholesale agent is extremely important. It is best to deal only with a specialist capsicum or chilli wholesaler. Seek advice on selecting wholesale agents from your local growers' association.

Maintain a good relationship with your wholesalers and keep them informed of the quantities of produce you are consigning and the standard (quality) of the produce.

Major retailing chains are important outlets for capsicums. Although some of their requirements are met from market supplies, they commonly also buy direct from growers. This is direct selling and is usually on the basis of an agreed pricing system and some form of quality assurance system. If possible visit the major market in which your fruit is sold at least once a season.



Sources of market information
Section 6 page 11

Prices

Prices are closely tied to supply, with higher prices paid during periods of lower production, especially if it coincides with a period of high demand.

Levies

All capsicums marketed by Queensland growers through agents, merchants or direct sales are subject to a levy under the Queensland Fruit Marketing Organisation Act. The levies are collected so that Queensland Fruit and Vegetable Growers (QFVG) can fund promotion, grower services and research. The levy is collected from the first point of fruit sales.

Processing

Processors buy significant amounts of capsicums and chillies. They generally arrange with individual growers for supply and transport of product in bulk, not packed for market.

Some condiment manufacturing companies buy chillies from the domestic wholesale markets.

In north Queensland several large operations are pre-processing or freezing their own capsicums. There is a major chilli processor in Bundaberg.

Marketing overseas

Capsicums can be exported to New Zealand, but chillies cannot.

The Commonwealth of Australia prints *Export control (fresh fruits and vegetables) orders*, which show the requirements for exporting fresh produce. As there is no specific schedule for capsicums, Schedule 1 of these orders should be used as a guide to the requirements for exporting capsicums to other countries. The cartons must be marked with the grower or packer's name and address, and Produce of Australia. The product must meet any description marked on the package.

Produce for export to countries that require a phytosanitary certificate may be grown and packed in an on-farm Registered Export Establishment (REE), or prepared for export in a premises which has current REE status for the commodity being exported, for example fresh fruit and vegetables.

Protocols have been established with certain countries (New Zealand and Japan) to access those markets. These guidelines are commodity specific and have been established for the product, within the protocols, from growing through to export. Produce exported to non-phytosanitary certificate countries must, at some stage within the export process, travel through a REE. This may be a packing shed, exporters' premises or a freight forwarder.

Some countries require exporters to obtain an import permit before export. This permit specifies the latest requirements for that country.

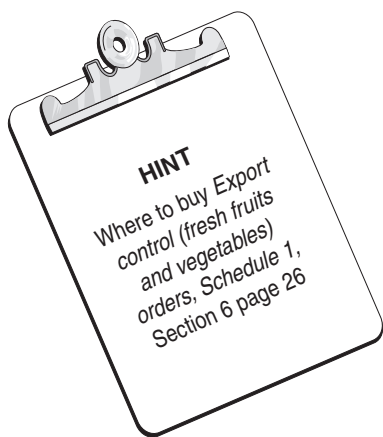

AQIS offices in Queensland
Section 6 page 15



Plant health coordinators
and contacts
Section 6 pages 15 – 18

The Australian Quarantine and Inspection Service (AQIS) supervises registration of establishments. Quarantine requirements vary between countries and intending exporters should keep informed through local AQIS offices.

Interstate quarantine requirements

Interstate requirements are subject to change so contact your local DPI plant health inspector. Plant health coordinators in major DPI centres can assist businesses with inspection services and arrange for property freedom accreditation. Growers are advised to confirm the details of requirements and fulfil them well before sending capsicums interstate.

There are no restrictions on the movement of capsicums within Queensland.