

# Rockmelon and honeydew information kit

Reprint – information current in 1997



## REPRINT INFORMATION – PLEASE READ!

For updated information please call 13 25 23 or visit the website [www.deedi.qld.gov.au](http://www.deedi.qld.gov.au)

This publication has been reprinted as a digital book without any changes to the content published in 1997. We advise readers to take particular note of the areas most likely to be out-of-date and so requiring further research:

- Chemical recommendations—check with an agronomist or Infopest [www.infopest.qld.gov.au](http://www.infopest.qld.gov.au)
- Financial information—costs and returns listed in this publication are out of date. Please contact an adviser or industry body to assist with identifying more current figures.
- Varieties—new varieties are likely to be available and some older varieties may no longer be recommended. Check with an agronomist, call the Business Information Centre on 13 25 23, visit our website [www.deedi.qld.gov.au](http://www.deedi.qld.gov.au) or contact the industry body.
- Contacts—many of the contact details may have changed and there could be several new contacts available. The industry organisation may be able to assist you to find the information or services you require.
- Organisation names—most government agencies referred to in this publication have had name changes. Contact the Business Information Centre on 13 25 23 or the industry organisation to find out the current name and contact details for these agencies.
- Additional information—many other sources of information are now available for each crop. Contact an agronomist, Business Information Centre on 13 25 23 or the industry organisation for other suggested reading.

Even with these limitations we believe this information kit provides important and valuable information for intending and existing growers.

**This publication was last revised in 1997. The information is not current and the accuracy of the information cannot be guaranteed by the State of Queensland.**

This information has been made available to assist users to identify issues involved in the production of rockmelon and honeydew. This information is not to be used or relied upon by users for any purpose which may expose the user or any other person to loss or damage. Users should conduct their own inquiries and rely on their own independent professional advice.

While every care has been taken in preparing this publication, the State of Queensland accepts no responsibility for decisions or actions taken as a result of any data, information, statement or advice, expressed or implied, contained in this publication.



Queensland Government



# *Growing* **THE CROP**

*This section is our recipe for growing and marketing a commercial crop of rockmelon or honeydew melons. Where the term melons is used it refers to both rockmelons and honeydews. To keep the section as brief as possible and easy to follow, we give little explanation with recommendations. Where more information may help, we refer you to other sections of the kit. Symbols on the left of the page will help you make these links.*



## **Getting the crop started**

**3**

*Preparing the land and planting the crop*



## **Looking after the crop:**

### **planting to first runners**

**19**

*Irrigation, pest management and nutrition*

### **first runners to fruit set**

**26**

*Key steps to growing quality melons*

### **fruit set to harvest**

**34**

*Monitor pest and irrigation needs*



## **Harvesting and marketing**

**37**

*The steps from harvesting to marketing*

# The rockmelon plant

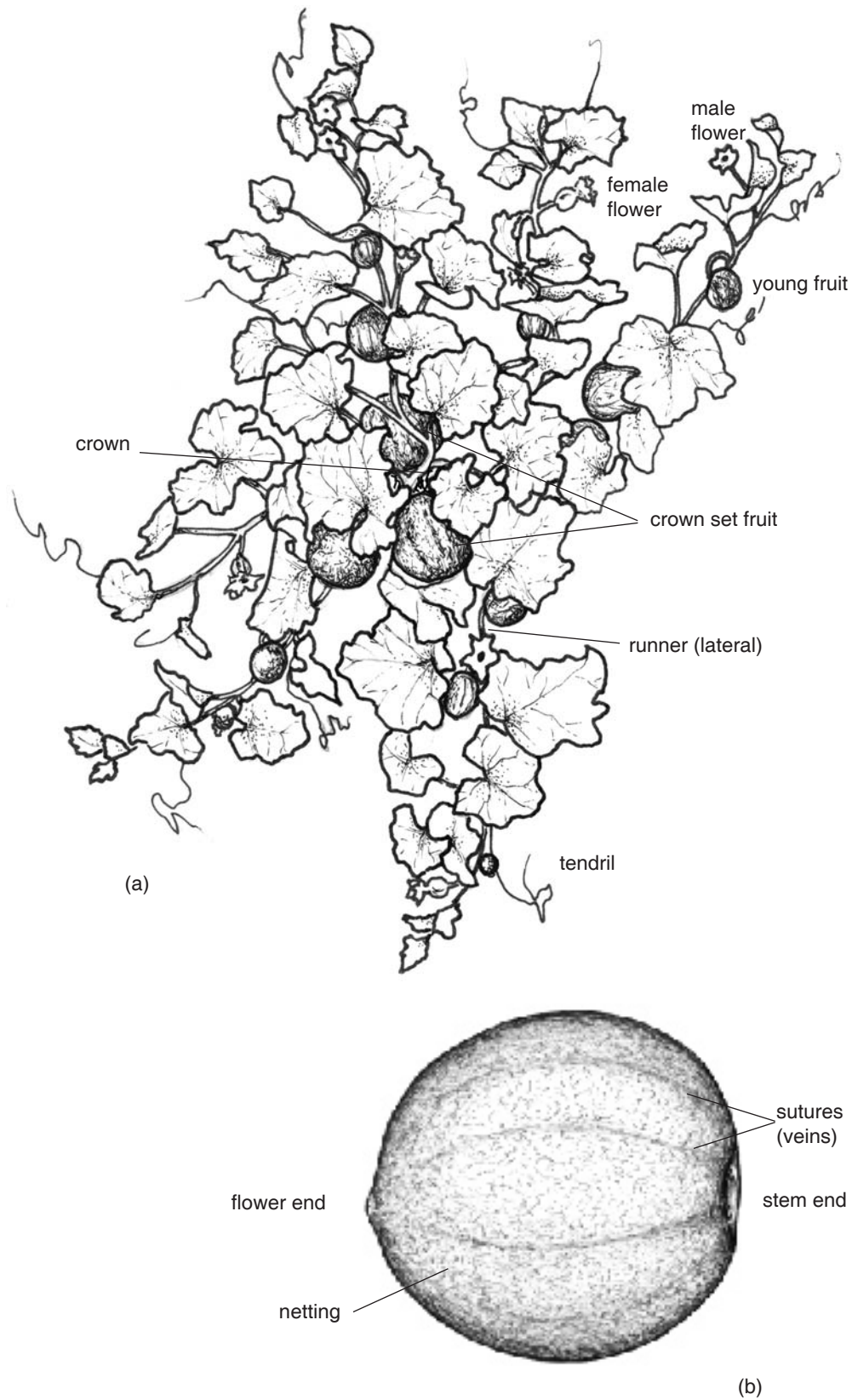

**Figure 1.** Above ground (a) parts of a melon plant with fruit near harvest, and (b) mature fruit



## Getting the crop started

*To give yourself the best chance of success, you need to start planning your crop and preparing the land at least four months before planting. This involves 12 key steps.*

Decide when to plant.....	3
Decide whether to use transplants or direct seed .....	4
Decide whether to buy plants or grow your own.....	4
Choose varieties .....	5
Order required number of transplants .....	5
Choose an irrigation system .....	7
Prepare the land .....	8
Lay out the field.....	12
Treat soil to control nematodes.....	13
Apply fertiliser, form beds and lay mulch.....	14
Look after transplants until planting .....	16
Plant.....	17

### **Decide when to plant**

---

#### **Soil temperature**

Soil temperature should be at least 15°C. Germination takes up to three days at 28 to 30°C, but may take 14 days at 15°C, with many seeds lost to soil-borne diseases. The deeper seeds are planted the longer they will take to emerge. Delayed emergence because of low temperatures often results in weak plants and poor crops. All these problems can be overcome by using transplants that have been grown in a heated environment.

#### **Time from planting to harvest**

The time from planting to harvest varies from 10 to 16 weeks after field planting, depending on variety, time of year, district, and whether

melons are planted as seeds or transplants. Crops from transplants often mature a little quicker than direct seeded plants. They also often have a more concentrated maturity time. Warm weather encourages quicker germination and growth, and earlier crops. Crops grown over winter will be slow, usually yield less and have poor external colour.

Harvest extends over two to four weeks, depending on temperature at the time and the amount of irrigation applied. Warm weather and dry conditions will concentrate harvest.

## **Decide whether to use transplants or direct seed**

### **Container grown seedlings (transplants)**

Plants are started in multi-celled trays. One seed is planted into a seedling mix in each cell. Transplant seedlings into the field once they will pull cleanly out of the tray, that is when the roots have fully penetrated the mix. This is usually when the second or third true leaf has just emerged.

For a comparison of the advantages and disadvantages of transplants and direct seeding, refer to the article in Section 4 *Key issues*.

### **Direct seeding**

Seed may be planted directly into the rows. In bare soil seed is planted closer than the final plant spacing and then thinned out. This can be more costly, particularly if planting hybrids. Where plastic mulch is used plant seed into the final position.

### **Mice**

Mice will dig out and eat seed and the crops may have to be replanted, resulting in late crops. Growers have tried different seed coatings to prevent mice finding or eating the seed but none have worked. Pre-germinating seed will reduce the risk of loss, as will planting container grown transplants. Mice will also take seed from seedling trays. Mouse baits may be effective in keeping numbers down.

## **Decide whether to buy plants or grow your own**

Unless you are experienced in growing seedlings we recommend that you buy transplants from an established nursery.

If you decide to grow your own transplants you should do a cost benefit analysis to determine whether it is economically viable. You will need above ground racks, a watering system, and an area to mix the potting mix and plant the seeds. You will also need to buy seedling trays, potting mix, a mixer, cleaning and sterilising equipment, and a plastic igloo for growing in cool weather.



a key issue

---

Transplants or direct seed  
Section 4 page 5

---



a key issue

---

Potting mix recipe  
Section 4 page 6

---



Choosing varieties  
Section 4 page 8

## Choose varieties

The varieties mentioned in this section are the ones most commonly grown. New varieties are frequently released. Test small plantings of new varieties to compare them to those grown on your farm, as varieties perform differently in different locations.

Almost all the honeydews produced in Queensland are grown in the Bowen – Burdekin area with most of the remainder grown in the Bundaberg district. Planting and harvesting times for honeydews are the same as for rockmelons. The main honeydew varieties are Casper, Dewcrisp, Dewette, Dewsweet, Honeybabe, Honeymoon and Sweet Success. Table 1 shows the main rockmelon varieties, and planting and harvest times for the main production districts. Harvesting is 10 to 16 weeks after planting.

**Table 1.** Rockmelon varieties and main planting and harvesting times

District	Variety	Planting time	Harvest time
Bowen – Burdekin	Dubloon, Eastern Star, Eldorado, Hot Shot, Ivanhoe, Malibu, Mission	February to April	Mid March to mid October
Rockhampton – Emerald	Eldorado, Eastern Star, Malibu, Hot Shot	June to July	Late September to October
Bundaberg	Eldorado, Eastern Star, Hot Shot, Malibu	Mid July to September	Late October to mid December
Gayndah – Mundubbera	Dubloon, Eastern Star, Hiline, Malibu, Hot Shot, Mission	August to September	November to December
Chinchilla – St. George		September to January	December to April

## Order required number of transplants

Table 2 shows plant spacing and some general information about planting.

**Table 2.** Plant spacing and seed information

		Comments
Space between rows	1.5 – 2 m	Depends on machinery to be used
Space between plants	40 – 60 cm	50 cm is the average
Direct seeding rate	750 g – 2 kg/ha	Only used when seed is cheap. Rate depends on seed size, plant density, number of seeds planted per site
Seeds per gram	25 – 55	Average is 40 seeds per gram



## Deciding how many plants you need

A commonly used planting arrangement is shown in Figure 2.

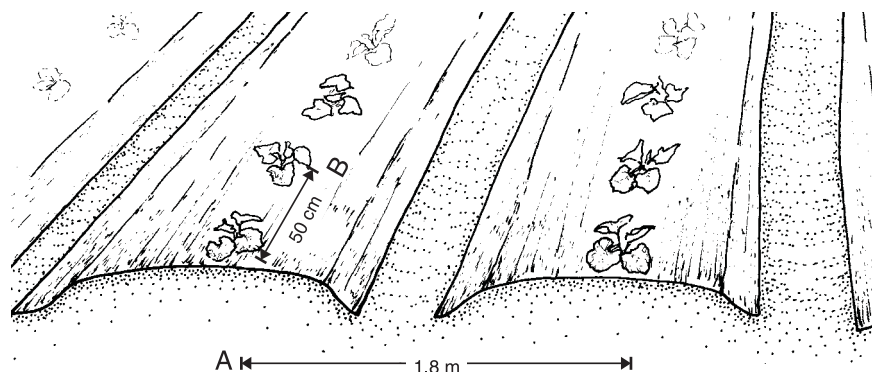

**Figure 2.** A commonly used planting arrangement for melons

Excluding headlands, the number of plants required per hectare (10 000 m<sup>2</sup>) is determined by:

- the distance in metres between the centre of each bed (A)
- the distance in metres between plants in the row (B).

Use a calculator to calculate the following formula:

$$(10\,000 \div A) \div B$$

*For example: How many plants will you need at 1.8 m bed centres (A) and 50 cm (0.5 m) between plants (B)?*

$$10\,000 \div 1.8 = 5555 \div 0.5 = 11\,110$$

plants per hectare

To help you, Table 3 shows our calculations for a number of different row and plant spacings.

**Table 3.** Number of plants per planted hectare at different row and plant spacings

Distance between rows	Distance between plants		
	40 cm	50 cm	60 cm
1.5 m	16 670	13 330	11 110
1.8 m	13 890	11 110	9 260
2 m	12 500	10 000	8 330

Note: The length of rows and the size of headlands will determine what area is required to plant one hectare of crop.

## Order transplants or seed

Contact transplant or seed suppliers for details of what varieties they have, when they will be available, and the price and delivery arrangements. Do this at least two to four months before your proposed planting date. If you have regular seedling suppliers, give them your planting

schedule before the season starts. Ordering early gives you the best chance of getting the varieties you want when you want them.

## **Choose an irrigation system**

Consult an irrigation equipment supplier or designer in your area and get them to develop an irrigation plan.



Irrigation systems  
Section 4 page 18



Cleaning trickle tape  
Section 4 page 27

### **Irrigation systems**

Trickle irrigation is the best and most common irrigation system, but furrow and overhead irrigation are sometimes used. Refer to Section 4 *Key issues* for details on the advantages and disadvantages of each system.

Trickle irrigation is the most easily controlled system. Although the equipment is expensive, it has a long life. If you plan to re-use trickle tubing, treat it with chlorine to reduce the risk of blockages. Soluble fertilisers and some pesticides can be applied easily through trickle systems.

Furrow irrigation requires an even, gentle slope and a soil type which allows water to spread laterally without penetrating too deeply into the soil. Furrows longer than 500 metres are not recommended. 'Tail end' water from the end of the rows must be removed to prevent waterlogging the lower section of the block.

Overhead irrigation includes travelling irrigators and sprinkler systems. It is suitable for any soil type and undulating country. Overhead irrigation can increase the risk of leaf and fruit diseases so it is rarely used for rockmelons and honeydews. Poor quality water applied over the plants will result in leaf damage.

### **Water quality**

Rockmelons and honeydews have a medium tolerance to salinity in irrigation water. At conductivity levels above about 1500 microSiemens per centimetre ( $\mu\text{S}/\text{cm}$ ) yield may be reduced. Increasing water salinity will cause decreasing yields. Using trickle or furrow irrigation systems allows poorer quality water to be applied than if using overhead irrigation.

### **Quantity of water**

Up to four megalitres (ML) of water should be available for each hectare of crop to be grown. The quantity required will vary with soil type, irrigation system, weather (for example hot dry winds) and plant spacing. Plastic mulch will reduce water use and improve lateral water spread on some soil types. Over watering can result in serious plant losses from sudden wilt.

A commonly used trickle irrigation tube with 20 centimetre outlet



spacing and operated at 0.55 bar (8 psi) inlet pressure should deliver about 500 litres per 100 metres of row per hour. The actual quantity applied will vary depending on the amount of slope, the pressure and whether the tubing is clean.

## Prepare the land

### Protect against erosion

#### Soil erosion

Uncontrolled runoff water removes valuable topsoil while the land is being prepared. Where slopes are greater than 5%, plan the farm layout to prevent erosion, and allow efficient irrigation and use of equipment. Uniform slopes (about 0.5%) are essential for furrow irrigation. If trickle or sprinkler irrigation is used uniform slopes are preferred but not essential. Avoid using slopes above 10%.

Whichever irrigation system you use some form of land levelling is necessary as melons are highly prone to waterlogging. Laser levelling in most districts will improve irrigation efficiency.

Department of Natural Resources land conservation extension officers provide on-site advice on farm layout.

#### Wind

Strong winds damage plants and young fruit. Permanent treed windbreaks are best, but a windbreak such as bana grass or an artificial windbreak will help. Strips of sorghum are sometimes planted between lands to give some protection to young plants. Table 4 shows some of the advantages and disadvantages of windbreaks.

**Table 4.** Advantages and disadvantages of windbreaks

Advantages of windbreaks	Disadvantages of windbreaks
Less twisting and damage to plant stems	Can increase risk of leaf diseases as plants remain wet with dew longer
Fewer small fruit and flowers lost	Can interfere with spraying
Bees are more likely to work in less windy conditions	Wastes some ground
Less wind-induced stress, so less fruit drop and blossom-end rot	May be too hot in late spring and summer

more info



Contacts  
Section 6 page 12



more info



Cover crops  
Section 3 page 9

### Crop rotation

To prevent a build-up of pests and diseases, rotate crops so that rockmelons and honeydews do not follow each other or any other cucurbit crop. Plant no more than one cucurbit crop a year on that land. Growing a cover crop in rotation with cash crops improves soil structure and productivity, and reduces pest and disease problems. Most other crops can be grown in a rotation with melons.

## A guide to land preparation

Here is a suggested land preparation schedule based on the number of weeks before planting.

**Table 5.** A suggested land preparation schedule

Weeks before planting	Activity
20	Cultivate soil, rip and fertilise if necessary, or add organic material. Plant green manure crop.
10 – 12	Slash cover crop if necessary to avoid hard, fibrous stems.
8	Sample soil for a nutrient analysis.
4 – 6	Mulch and plough in green manure crop. Apply and incorporate lime or dolomite according to soil analysis results.
2 – 4	Disc cultivate soil once or twice to speed break down of green manure crop.
0 – 1	Final working of soil just before planting.
0	Plant the crop.

**Initial cultivation.** If your land is under grass or weeds, plough or disc the block. A hard pan or compaction layer may be formed from regular use of a rotary hoe and other cultivation equipment or from heavy traffic movement (Figure 3). This causes reduced plant growth and waterlogging in some situations. Deep rip in both directions to break this hard pan. If the soil is wet it will not shatter; if too dry large clods will be formed.

Ripping is best immediately after final harvest to allow water to penetrate deeply during fallow and salts to be leached out of the root zone.

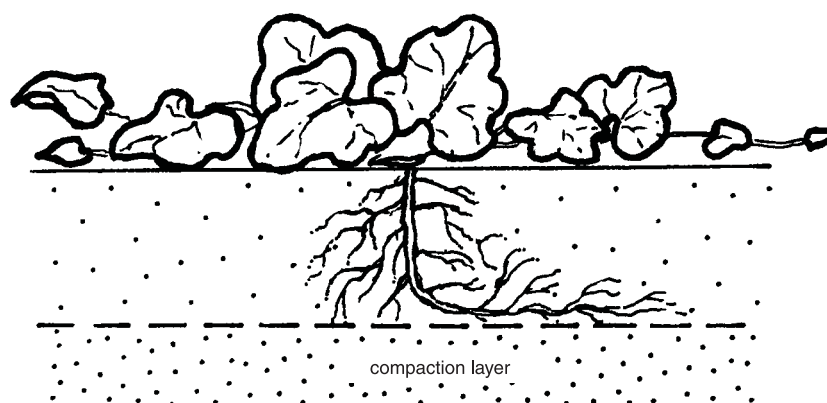

**Figure 3.** Root system affected by a compaction layer

**Organic additives.** Organic additives such as filter press or mill mud from sugar mills (15 tonnes per hectare), deep litter fowl manure (5 t/ha) or cattle feedlot manure (10 t/ha) may be used to increase organic matter in the soil. Take care not to increase nitrogen levels too much.

**Cover crops or green manure crops.** These crops build up soil organic matter and reduce weeds in the following crop. Increasing the soil organic matter helps retain moisture and nutrients; maintain soil micro-organisms and improve soil structure. If growth is slow apply

100 kilograms per hectare of nitram (30 kg/ha of nitrogen) after emergence.

Legumes such as cowpea and dolichos are susceptible to nematodes. The cover crops suggested below should not result in any build-up of nematodes.

**Summer.** Broadcast hybrid forage sorghum seed over the cultivated land at 20 to 30 kg/ha. Use the higher rate where the seedbed is rough and the seed will not have good soil contact. For best germination, use harrows or a light tined implement after planting to mix seed into the soil. Light rolling will improve germination by ensuring that seed is in closer contact with the soil. Water as required.

Forage sorghum can be ratooned several times by slashing. Extra nitrogen may be required if the crop is slashed and allowed to regrow. Slash back to a height of 20 to 30 cm, or plough in before seed heads develop and the stems get too fibrous to decompose rapidly.

In north Queensland, the legume dolichos or hybrid forage sorghum are planted from November to January.

**Winter.** Few northern growers grow a winter cover crop. In south Queensland cereals such as oats, triticale or barley at 75 kg/ha are suitable. Use oats for early planting and barley for late planting.

**Soil analysis.** A soil analysis takes the guess work out of fertiliser scheduling. Take the sample six to eight weeks before your intended planting date. Follow the sampling instructions supplied by the laboratories.

A soil analysis measures the pH, conductivity, organic matter and the level of nutrients in the soil. Results will be interpreted by the laboratory and should be back in about two weeks, allowing time for the treatments to be incorporated into the soil. Your experience of the block of land, and the way you wish to manipulate the growth pattern of the crop, will influence your interpretation of the soil analysis.

**Soil pH.** The pH level is a measure of the soil's acidity or alkalinity on a scale from 0 to 14, with 7 being neutral. A pH of 5 is 10 times more acid than a pH of 6. Melons prefer a slightly acid soil, around 6.0 to 6.5. In this range, most major and trace elements present in the soil are available to the plants, without being at toxic levels. Many Queensland soils are acidic and require the addition of lime or dolomite to raise the pH. Table 6 is a guide to the application rates for lime or dolomite.

**Table 6.** Lime or dolomite needed to raise soil pH to about 6.5

Soil type	Sandy loam	Loam	Clay loam
pH range	t/ha	t/ha	t/ha
4.5 – 5.0	5.00	6.25	7.50
5.0 – 5.5	2.50	3.75	5.00
5.5 – 6.0	1.25	2.50	3.75

Table 7 is a guide to which product is most suitable for your situation.

**Gypsum.** Application of gypsum will increase soil calcium levels but does not change soil pH. It takes about one year for the effects of gypsum to become apparent. Apply gypsum before the wet season so that it can leach accumulated salts beyond the root zone well before planting. Soil must have good internal drainage to benefit from gypsum. Table 7 shows the appropriate management of calcium, magnesium and pH.

An application of 5 to 10 t/ha of gypsum can benefit heavy clay loams that have high sodium levels and a pH higher than 8.0.

**Table 7. Management of calcium, magnesium and pH**

Recommended action	Soil nutrient status							
	pH high				pH low			
	Calcium high		Calcium low		Calcium high		Calcium low	
Mg high	Mg low	Mg high	Mg low	Mg high	Mg low	Mg high	Mg low	
Gypsum 1 – 2 t/ha			✓	✓				
Dolomite 2.5 – 5 t/ha							✓	✓
Lime 2.5 – 5 t/ha					✓		✓	
Magnesium sulphate (MgSO <sub>4</sub> ) 100 – 250 kg/ha		✓		✓		✓		

**Final land preparation.** Plough in the organic matter to 20 to 25 cm deep, then work the soil to a fine tilth for planting. All organic matter should be incorporated into the soil well before planting to allow it to decompose completely to avoid serious losses from damping-off diseases. Decomposition takes about four weeks in warm, moist soil and eight weeks or longer in cold or dry weather.

In very dry conditions it may be necessary to apply about 25 kg/ha of urea and irrigate to encourage decomposition by soil micro-organisms. Otherwise the organic matter decomposes when the crop is first irrigated, resulting in heavy seed and plant losses.

Soils are normally worked twice with disc or tine cultivators and then brought to a clod-free condition using rigid or spring tine cultivators and harrows. Use a rotary hoe for final land preparation when applying fertiliser and bedding up.

**Trace elements.** If trace elements are deficient they are best applied to the soil just before the final cultivation. Soil applications will often last for a few years, whereas foliar applications only benefit the plants to which they are applied. Table 8 lists the most commonly deficient trace elements.

**Table 8.** Soil application rates of commonly deficient trace elements

Element	Product	Rate per ha	Comments
Boron	Solubor	2 – 3 kg	Spray on the soil. Solubor is NOT compatible with zinc sulphate heptahydrate. Boron may be tied up in alkaline soils. Apply as a foliar spray in these situations.
Zinc	Zinc sulphate heptahydrate	30 kg	Spray on the soil. Do not mix with boron.
	Zinc sulphate monohydrate	20 kg	

**Weed control.** Weed control starts with ploughing out the previous crop before weed seeds can germinate. Regular cultivation with tined implements will prevent a build-up of weeds.

Most crops are grown on plastic mulch which controls weeds. No pre-emergent herbicides are available for use on rockmelons and honeydews.

## Lay out the field

Fields are subdivided into cropping areas called lands. These are usually twice the working width of the spray equipment and harvesting booms to be used (Figure 4). Rows are commonly spaced 1.5 to 2 m apart, with seven to ten rows per land. Leave 4 m wide roadways between lands to allow spray equipment and harvesting trailers to be moved without damaging the crop.



Irrigation  
Section 4 page 18

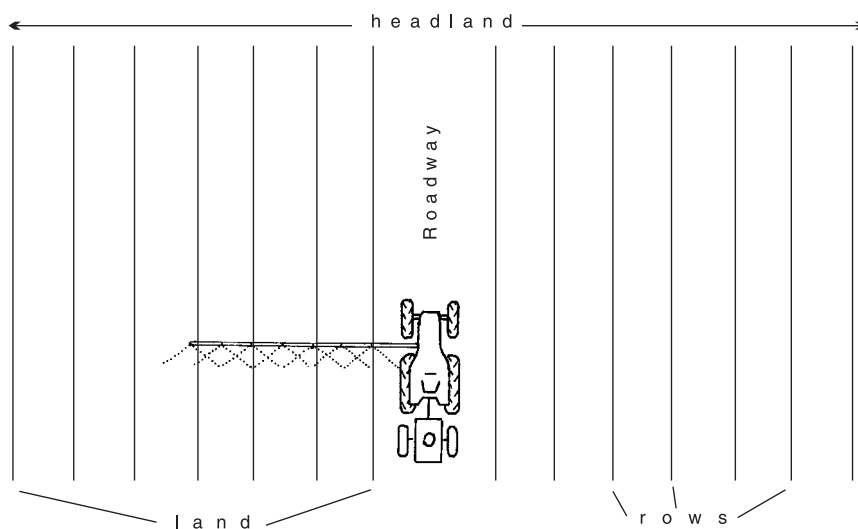

**Figure 4.** Field layout. Lands (cropping areas) are twice the working width of spray booms and harvesting equipment

The length of row used with trickle irrigation depends on the slope of the land. The accuracy of water distribution decreases after about 120 m under ideal conditions. Place additional 'lay flat' irrigation tubing across the rows to increase row lengths.

If possible divide blocks into uniform soil types for easier and more efficient cultivation, irrigation and fertilising. Provide all weather access to the block and allow room for vehicles to turn easily at the end of rows. Design the layout so that new plantings are made into the wind to reduce pest and disease movement from older plantings.

### Mark out rows

Rows are marked out using the wheel marks of a tractor which is set at the normal row spacing. After the first row is marked out the driver need only follow on the outside wheel mark to obtain the correct spacing. Pre-plant basal fertiliser can be applied when rows are marked out.



Problem solver handy guide

### Treat soil to control nematodes

Nematodes, particularly rootknot nematode *Meloidogyne* spp., can be a serious problem, especially in sandy soils or in soils that have previously grown susceptible crops or weeds.

A nematicide or fumigant is often used as insurance against losses, because once plant damage is noticed it is too late to control nematodes. Chemicals used to control nematodes can be applied as either fumigants or soil incorporated chemicals.

Fenamiphos (Nemacur 400) can be applied to control nematodes. Follow the label instructions carefully. Spray the chemical over the soil and cultivate immediately with a rotary hoe or rotary tines to 20 cm deep. The soil should be moist but not wet. As the chemical is toxic, wear full protective gear.

### Fumigation

Fumigation refers to the injection or incorporation of chemicals into the soil before planting to control nematodes, weeds and some soil-borne pests and diseases. Use a broad spectrum fumigant such as methyl bromide/chloropicrin, metham (Metham, Vapam) or dazomet (Basamid).

The methyl bromide/chloropicrin fumigant is an extremely efficient chemical on nematodes. Because of its high cost, its use can only be justified if other soil diseases and weeds such as nut grass are an anticipated problem. Although methyl bromide is gradually being phased out, it is still the recommended fumigant.

Before application, work the soil to a fine tilth to 25 cm deep. Soil must be moist, free from clods and undecomposed organic matter, and warmer than 15°C. Methyl bromide is highly toxic and is applied under plastic sheeting. Hire an experienced operator with the necessary specialised equipment to perform this operation safely.



Alternatives to methyl bromide  
Section 4 page 30



There are two ways of applying the fumigant.

- Fumigate the whole block before the beds are formed.
- Only treat the strips to be planted. The beds are formed, the fumigant applied and the plastic mulch laid, all in the one operation. This is cheaper, but diseases and weed seeds can remain between the rows in the unfumigated soil.

After treatment the soil must be aerated to allow the gas residues to escape or plants can be damaged. If the whole block is fumigated, remove and discard the covering sheet. If strips are fumigated leave the plastic mulch in place and delay planting for at least one week and probably longer in winter. If cress or lettuce seed will germinate in the treated soil it is safe to plant.



Nutrition  
Section 4 page 14

## Apply fertiliser, form beds and lay mulch

### Apply pre-plant (basal) fertiliser

All fertilising should be based on the results of a soil analysis. If no soil analysis is available use the following as a guide. The pre-plant fertiliser should contain the total phosphorus requirement, 50 to 100% of the nitrogen and 50 to 100% of the potassium requirement. For medium to heavy soils the total fertiliser requirement may be applied before planting. For lighter soils prone to leaching apply the remaining nitrogen and potassium as a side dressing if required. Use Table 9 as a guide. The lower rates should be used on very fertile soil or where irrigation is limited.

**Table 9.** A guide to fertiliser rates

Fertiliser N:P:K	Quantity to apply	
	kg/ha	kg/20 m at 1.8 m rows
13:15:12	250 – 500	0.9 – 1.8
5:6:5	650 – 1300	2.3 – 4.7

Pre-plant fertiliser is best spread as a 30 to 40 cm band over the row and incorporated into the soil (Figure 5a). However, it may be drilled 10 cm below ground level directly under the sowing position, or 10 cm to one or both sides of the row (Figure 5b). Banding is suitable for most soils, while drilling is best in red soils which tie up phosphorus.



**Figure 5a.** Pre-plant fertiliser, banded



**Figure 5b.** Pre-plant fertiliser, drilled

### Form beds and lay mulch and trickle tubing

Melons are grown on raised beds, usually with polythene mulch. The mulch controls weeds, keeps the fruit clean and reduces fruit rots.

Beds can be formed and mulch laid several weeks or immediately before planting. Laying mulch well before planting ensures that the beds are ready. The crop can be planted even if wet weather would otherwise have interrupted land preparation. In hot weather, if the polythene mulch is laid for some time before planting, fewer weeds may grow through the planting hole after planting.

Use a bed-forming machine to mound the soil in rows, then shape and compact the mounds to prevent sinking. Bed-formers usually have attachments to lay trickle tube and plastic mulch at the same time.

In shallow soil, form rows into low broad hills (15 cm high and 80 to 90 cm wide) to increase soil depth and reduce the risk of waterlogging. Narrow, steep hills dry out too quickly and stress the plants. Form beds like those shown in Figure 6. Adjust the distance between beds to suit the track width of your tractor.

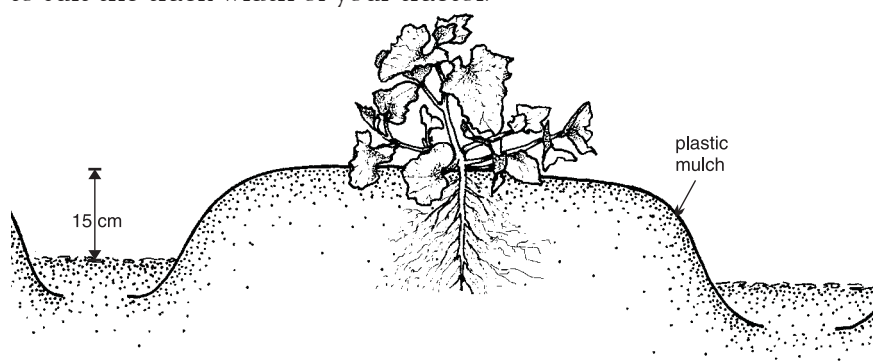

**Figure 6.** Plastic mulch over a well formed bed

The polythene mulch should be at least 120 cm wide so that the top of the bed will be 50 to 80 cm wide. Make sure the mulch fits tightly over the bed. Polythene mulch comes in four colours—reflective silver, grey, black, and white. Reflective silver mulch will reduce early virus infection by deterring the aphid vectors from landing in the crop until the vine has covered the mulch. Black mulch warms the soil and is

preferred for winter plantings. Grey and white plastic mulch are used in hot weather to reduce soil temperatures.

Reflective silver, grey or white mulch is generally available in rolls up to 120 cm wide and black in rolls up to 200 cm wide. The larger widths may be difficult to obtain in small quantities. Table 10 shows the length of plastic mulch and trickle tubing required for one hectare at various row spacings.

**Table 10.** Length of plastic mulch and trickle tubing required per hectare

Distance between rows	Metres of plastic and trickle tubing per hectare
1.5 m	6667
1.8 m	5556
2 m	5000

### Trickle tubing

The capacity, quality and price of trickle tubing varies depending on the type and manufacturer. Cheaper, thinner tubing is commonly used and discarded after the crop has been harvested. Thicker, more expensive tubing is used if crickets have caused problems by chewing the tape. This tubing can be re-used if you are careful retrieving it. Lay trickle tubing with the holes up to prevent blockages from sediments.

## Look after transplants until planting

### Hardening off

The greatest cause of seedling losses is planting out 'soft' plants that have not been hardened off as they are unable to survive the sudden change from the growing house to the field. In north Queensland seedlings are not generally grown under cover so hardening off is not as important. One week before planting out stop nutrient foliar sprays and reduce watering. Where plants were grown under cover, either remove the cover over the trays or move trays into the open to prepare the plants for field conditions.

### Treatment before planting out

A nutrient drench immediately before planting out will help plant establishment. Discard weak or diseased plants as they are unlikely to establish or produce well. If pesticides have been applied close to planting out wear gloves when planting.

### Trace elements

Apply trace elements if deficiencies developed in previous crops or where soil analysis results suggest a possible deficiency. Spray to wet the leaves only, not to have runoff, to prevent leaf burn. Do not apply foliar nutrients with pesticide sprays. Adding urea at 50 g/10 L of water will increase the leaf's absorption of trace elements.

To prevent molybdenum deficiency, spray seedlings with sodium molybdate (6g/10 L) or another source of molybdenum. For zinc deficiency, apply zinc sulphate heptahydrate (10g/10 L) before planting.

## Plant

### Seed treatment

Before planting seeds may be treated to control disease organisms on the seed surface. Most seed is treated before sale, but if it is not use one of the treatments listed in the *Problem solver handy guide*.



Seed treatment  
Problem solver  
handy guide

### Planting

The planting method depends on whether you use transplants or seed.

### Planting container grown seedlings

Seedlings can be machine or hand planted into bare soil or through plastic mulch. Waterwheel and cup planters are suitable. Planters usually have two people per row to plant. Plant only sturdy seedlings that have been hardened off.

Seedlings should pull easily from the trays when the second or third true leaf appears (Figure 7). Stems can be damaged by squeezing to pull the plant out and this increases the risk of fungal infections. If plants are too tight in the tray the mix may be too dry. Loosen plants by tapping the bottom of the tray or dropping it a few centimetres onto a hard flat surface

Take the following precautions:

- keep transplants moist while awaiting planting;
- make sure the potting mix is just covered with soil;
- irrigate the plants immediately after transplanting to firm the soil around the plant.

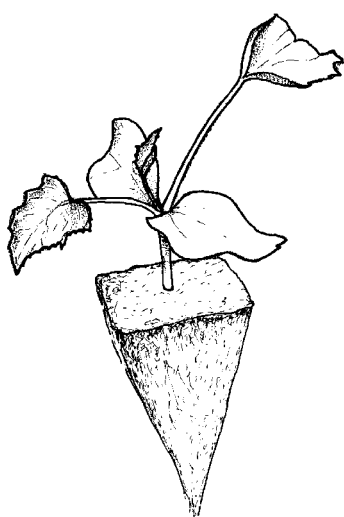

**Figure 7.** A seedling ready for planting at the third true leaf stage

### Planting seed in the field

If you are not using plastic mulch, plant seeds closer in the row than required then thin to the required spacing. Seed can be machine or hand planted. Firm the soil around the seed. Plant 30 millimetres deep in warm soil and 15 to 20 mm deep in cool soil.

If planting through plastic mulch, machine or hand plant seeds at the final spacing. Waterwheel and cup planters are suitable. Seed can also be hand planted through holes made in the plastic.

**Mice**

Mice will dig out and eat large quantities of seed. Baits may be effective in keeping mouse numbers down. Place baits around the perimeter of the field. If baits are placed under a sheet of corrugated iron or similar, it will provide shelter for mice and lure them to the baits. It will also prevent birds from getting baits.



## Planting to first runners

This stage takes up to three weeks for transplants and up to five weeks for direct seeded crops. Figure 8 shows this stage. There are five important things to manage during this stage.

Monitor soil moisture and irrigate .....	19
Manage pests and diseases .....	21
Control weeds .....	24
Prevent frost damage .....	24
Nutrition .....	25



**Figure 8.** Emerged seed (a), transplant (b) and first runners (c)

### **Monitor soil moisture and irrigate**

Irrigate immediately after planting and keep soil moist but not wet until plants are well established. A frequent cause of poor establishment is insufficient or infrequent irrigation after transplanting. If the potting mix is not kept moist it will shrink, forming a small air layer between the mix and the soil. The roots cannot cross this air barrier so the plants will not grow. The mix is hard to re-wet once dried out so keep it moist until roots are well established in the soil. Do not over water, especially from June to early August when the soil is cold.



*Planting to first  
runners*

## Irrigation scheduling

The decision on when to irrigate has often been made by feeling the soil, looking at the plants or watering at a pre-determined time interval. It is better to schedule irrigation with much greater precision by using instruments such as the Enviroscan and tensiometers.

**Enviroscan.** This is an expensive piece of equipment which is generally used only by crop consultants and large scale growers. It uses electrical induction to give a complete profile of moisture conditions throughout the root zone. By using this information, you can determine the daily water use and time to the next irrigation.

**Tensiometers.** These are comparatively cheap and effective instruments for irrigation scheduling. They show changes in soil moisture, so indicate the actual needs of the crop. Two tensiometers should be used per site. Place the tip of the shallow tensiometer in the root zone about 15 cm deep (a) and the other the deep tensiometer, just below the main root zone at about 45 cm deep (b). Figure 9 shows the correct placement for tensiometers. The shallow tensiometer indicates when to irrigate, while the deep tensiometer indicates how much water to apply.

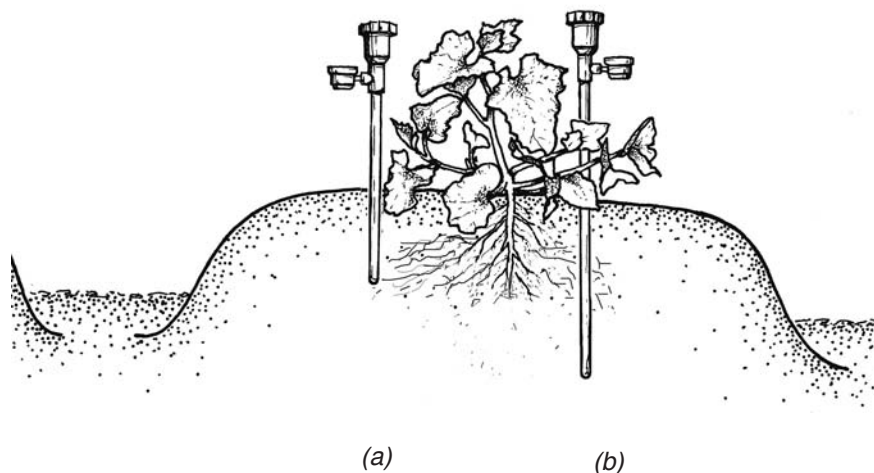

**Figure 9.** Tensiometers in place, (a) in root zone and (b) below main roots

Once tensiometers are installed, read the gauge to determine when to water. Remember, read tensiometers between sunrise and 8 a.m. because at that time there is little movement of water in the soil or plants and they are almost in equilibrium. Errors caused by heating of the gauge or water column are also avoided.

## Irrigation timing

Apply irrigation at different readings depending on soil type and stage of growth. The following is a guide to water requirements for this stage. See also Table 11.

a key issue



Irrigation  
Section 4 page 18

*Planting to first runners*

**Planting to establishment (up to two weeks)**

Under plastic mulch and trickle irrigation, one irrigation may be enough to get the plants growing. Apply small quantities frequently until plants have enough roots for tensiometers to be effective.

**Establishment to first runners**

Once plants have started to grow after transplanting they may need less frequent but increasing quantities of water. Allow soil to dry out a little at this time to encourage development of a strong root system. This will reduce the risk of heavy losses caused by sudden wilt as fruit matures.

**Table 11.** *Suggested shallow tensiometer readings*

Soil type	Tensiometer reading
Sandy loams	10 – 30
Clay soils	20 – 35

**Manage pests and diseases**

Serious pests and diseases are likely at some stage in the crop and can cause major and even total crop losses. Good management of pests and diseases includes monitoring, timely spray applications and using an integrated pest management (IPM) approach.

**Insect and mite pests**

Check your crop regularly during the first few weeks for cutworm and wireworm damage. Cutworms chew plants off just above ground level. They curl up in the soil at the base of the plant during the day, and can be found by scratching around the base of plants. False wireworms will also chew the plant stem below ground level. If cutworms and false wireworms are known to cause problems, apply an appropriate chemical from the *Problem solver handy guide*.

Aphids spread mosaic viruses which can severely reduce the marketable crop. Other pests of rockmelons and honeydews at this stage include cucumber moth, heliothis grubs, leaf-eating beetles, Rutherglen bugs and spider mites.

To control these pests choose an insecticide that controls the range of insects you have found in the crop. If overhead watering, spray late in the afternoon when the plants are dry. Use an appropriate chemical from the *Problem solver handy guide*.

**Diseases**

Two of the most serious diseases of cucurbits are powdery mildew and mosaic virus. Spray with an appropriate chemical from the *Problem solver handy guide*.



Pest and disease management  
Section 4 page 30



Cutworms and false wireworms *Problem solver handy guide*



Pests  
Section 5  
*Problem solver*

### Planting to first runners

more info



Diseases  
Section 5 *Problem solver*

a key issue



Section 4 Key issues;  
Section 5 *Problem solver*

more info



Section 5 *Problem solver*

### **Powdery mildew**

Powdery mildew is serious in susceptible melon varieties but can be controlled by fungicides. Late crops are generally most severely affected. Chemicals used to control powdery mildew are either protectants or systemics (see *Selecting chemicals* on this page). A protectant chemical is usually applied at this stage.

### **Mosaic virus**

Zucchini yellows mosaic virus (ZYMV) and papaya ringspot virus, cucurbit strain (PRSV-W)—formerly watermelon mosaic virus type 1 (WMV-1)—can severely affect melons. Watermelon mosaic virus type 2 causes only mild fruit distortion. These viruses are spread by aphids, which can be carried several kilometres by wind. Losses are greatest if crops are infected before or during the main fruit setting period.

### **Other diseases**

Other diseases that can infect melons at this stage include alternaria leaf spot, angular leaf spot, anthracnose, bacterial spot, damping-off, downy mildew, fusarium wilt, gummy stem blight and *Sclerotium rolfsii*. Spray with an appropriate chemical from the *Problem solver handy guide*.

### **Suggested spray schedule**

A regular spray schedule is suggested to prevent serious pest and disease problems. Table 12 shows a possible spray schedule.

Add an insecticide or miticide as required. Under wet conditions use a systemic fungicide effective against downy mildew. Do not use Morestan closer than two weeks before or three weeks after oil sprays. DO NOT use sulphur on rockmelons and honeydews.

**Table 12.** A suggested spray schedule for melons

Pest or disease	Chemical	Frequency (days)	Comments
Mosaic	Oil + aphicide	5 – 10	Spray if mosaic is expected to reduce yields
Most leaf spot diseases	Mancozeb	7 – 10	Spray more often in showery conditions or use a systemic fungicide
Powdery mildew	Morestan	7 – 10	DO NOT use if oil sprays are used. After fruit set alternate with a systemic fungicide

### **Selecting chemicals**

Use the most effective chemical. Chemicals are either protectant or curative, and systemic or non systemic. A protectant chemical will not eradicate a pest. It provides a protective cover which prevents the pest from getting established, so good coverage is essential. Eradicant chemicals will control a pest which is already established.

### Planting to first runners



more info



Pest and disease management  
Section 4 page 30



Systemic chemicals penetrate the leaf or roots into the sap stream and are transported through the plant with the sap stream. They will control a pest which is already established. Although coverage is not as important with systemic chemicals, good coverage will give best results.

Only chemicals registered for control of the particular pest on your crop can be used legally.

### Application of chemicals

Most chemicals are applied as sprays. The results you get from spraying will only be as good as the coverage you achieve with your equipment. An engine powered sprayer is recommended. These include hydraulic sprayers (hand held or tractor mounted boom), air blast machines and controlled droplet applicators. Hand operated knapsack sprayers are often not capable of sufficient coverage.

Good pest control is only achieved through good coverage of the plant, particularly for protectant chemicals. Spray equipment must be calibrated regularly to achieve this and nozzles changed when they start to wear.

Do not apply herbicides with your pest and disease sprayer. This avoids the risk of herbicide residues in the sprayer damaging the crop.

For more detail on safe and efficient spray application refer to the DPI publication *Pesticide application manual* (2nd edition).

### Care with chemicals

Agricultural chemicals should always be handled responsibly and with care. They are most dangerous when undiluted. Protective clothing, including boots, overalls, gloves and a mask, should be worn at all times. ALWAYS READ THE LABEL before opening the container. Use according to directions only. Avoid spraying if spray is likely to drift off the crop. Dispose of waste chemicals and containers thoughtfully to protect the environment.

### Bird and animal pests

Plants may be chewed off by ducks, hares, rabbits and wallabies or kangaroos. If hares, rabbits, wallabies and kangaroos are a problem, erect a netting or electric fence around the perimeter of the block. A trail of dried blood around the block may work for a few days. Wallabies and kangaroos are protected and problems with these animals should be referred to the Queensland National Parks and Wildlife Service (QNPWS). Hares and rabbits are not protected. Mice and rats are best controlled by baiting. Figure 10 is a diagram of an electric fence designed to keep hares and rabbits out of a melon crop.

Planting to first  
runners

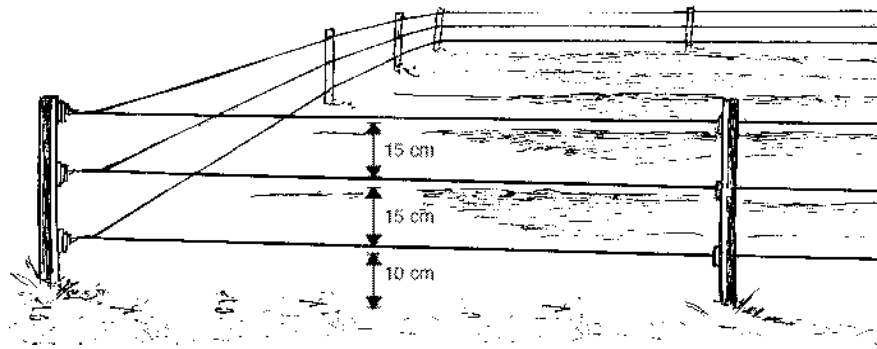

**Figure 10.** A diagram of an electric fence to exclude hares and rabbits from melon crops

Not all birds in the crop will cause damage. Most will be eating insects, so are beneficial. Most native birds are protected and cannot be trapped or destroyed without a permit from the QNPWS. A permit will only be issued after an inspection by a QNPWS officer. You must be able to show evidence of significant damage and that you have tried other deterrent methods. Scare guns and suspended hawk kites are used but are not very effective.

### **Control weeds**

Control weeds between rows using a knockdown herbicide such as a paraquat/diquat mix. Apply at low pressure and use shielded fan nozzles to prevent drift onto the crop. Fusilade and Sertin are knockdown herbicides registered to control grass weeds. They can be sprayed over the plants but will only control grasses not broadleaved weeds. Table 13 shows herbicides that can be used in melons.

Interrow cultivation in the early stages followed by spot chipping later is the normal practice for unmulched crops. Melon plants can be thinned out at the same time as an early chipping.

Some weeds may grow up through the planting holes around the plants. Remove these weeds by hand. Do not disturb the plant roots.

### **Prevent frost damage**

Melon plants are sensitive to frosts and should not be planted in frosty locations. Plants are damaged by temperatures below freezing point (0°C). Provided the plants are kept covered by a thin film of water they will not be damaged even if the air temperature falls below 0°C. This procedure is only possible if you have overhead irrigation equipment.

Planting to first runners

**Table 13.** *Herbicides for controlling weeds*

Chemical	Products	Rate per ha	Rate per 100 L	Notes on use
These chemicals are for use between rows				
diquat	Reglone	1.4 – 4 L		Shield the nozzle to stop drift
paraquat	Gramoxone	1.2 – 2.4 L	200 – 400 mL	Shield the nozzle to stop drift
	Maxitop			
	Uniquat			
	Nuquat	1.5 – 3 L	250 – 500 mL	
diquat + paraquat	Spraysseed	2.8 L	240 – 320 mL	Shield the nozzle to stop drift
	Fusilade	3 – 4 L	300 – 400 mL	
These chemicals control grasses only				
fluazifop	Targa	500 mL – 1 L	125 mL – 1 L	35 day withholding period
quizalofop-P-ethyl	Sertin 186	125 – 750 mL		Honeydew melons only, 63 day withholding period
sethoxydim	Sertin Plus	1 L + 1 – 2 L crop oil		28 day withholding period
		1.6 L		

## Nutrition

### Trace elements

Apply trace elements if deficiencies have developed in previous crops or where soil analysis results suggest a possible deficiency. Do not exceed the rates suggested below. The addition of urea at 500 g/100 L of water will increase the leaf's absorption of trace elements. Only spray to wet the leaves, not to have runoff, otherwise leaves may burn. Apply foliar nutrients separately, not combined with pesticide sprays.

**Boron.** Apply Solubor (200 g/100 L) at the four to five true leaf stage. Do not mix with zinc sulphate heptahydrate.

**Molybdenum.** Apply as sodium molybdate (60 g/100 L) or another molybdenum source at the four leaf stage (Figure 11) and again three weeks after transplanting.

**Zinc.** Apply zinc sulphate heptahydrate (100 g/100 L) if a deficiency becomes apparent.

**Figure 12.** *First runners to fruit set*

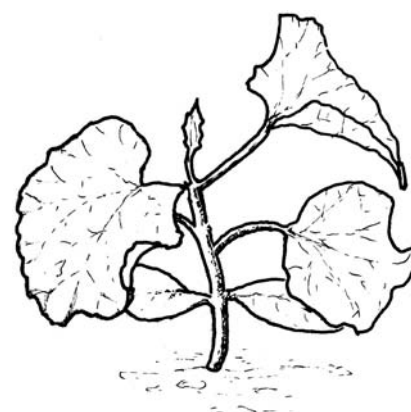





## First runners to fruit set

This stage can take up to five weeks and is shown in Figure 12. There are six important things to manage during this stage.

Manage pests and diseases .....	26
Control weeds .....	28
Nutrition .....	28
Irrigate.....	31
Train vines .....	32
Pollination .....	32

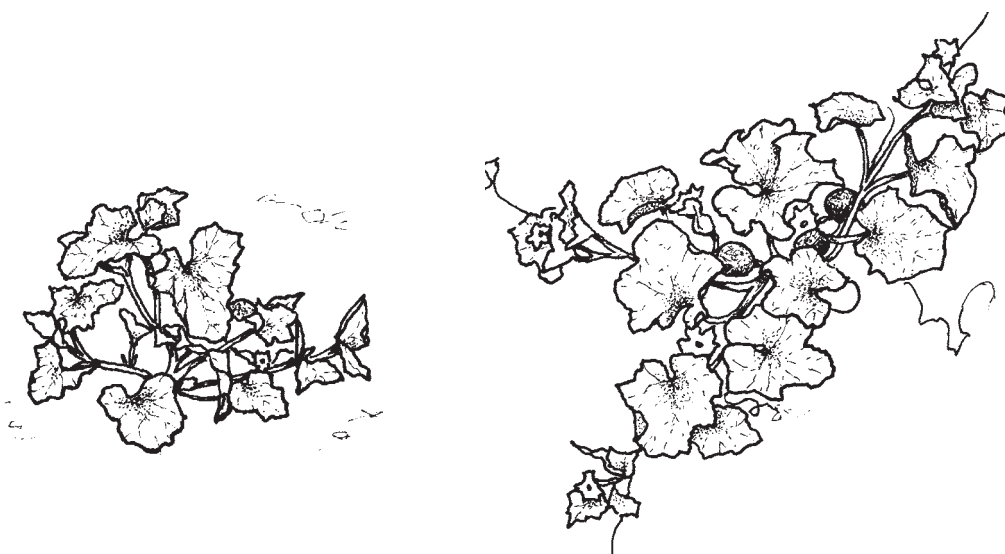

**Figure 11.** The four true leaf stage. Note the two seed leaves plus four true leaves

### Manage pests and diseases

#### **Insect and mite pests**

Insect and mite pests that affect rockmelons and honeydews at this stage include aphids, cucumber fly, cucumber moth, heliothis grubs, leaf-eating beetles, Rutherglen bugs, spider mites and silverleaf white-fly. Spray with an appropriate chemical from the *Problem solver handy guide*. During flowering use chemicals that are not toxic to bees.



Pests and diseases  
Section 5 *Problem solver*

*First runners to fruit set*

---

more info



Section 5 *Problem solver*

---

a key issue



Pest and disease management  
Section 4 page 30

## Diseases

The most serious diseases to guard against at this stage are powdery mildew, downy mildew and mosaic virus. Other diseases that can occur include alternaria leaf spot, angular leaf spot, anthracnose, bacterial spot, fusarium wilt, gummy stem blight, *Sclerotium rolfsii* and sudden wilt complex. Spray with an appropriate chemical from the *Problem solver handy guide*.

Resistance may develop to the highly active systemic fungicides such as those used for mildew control. Resistance is less likely to develop if these fungicides are used strategically in a program with protectant fungicides.

### Powdery mildew

Use the strategy below for control of powdery mildew at this stage. Table 14 shows the five groups of fungicides for control of powdery mildew.

**Table 14.** *The fungicide groups for control of powdery mildew*

Group C (DMI)	Group E (morpholine)	Group F (phosphoro-thiolate)	Group H (hydroxy-pyrimidine)	Group X (unspecified)
<b>systemics</b>				<b>protectant</b>
Bayfidan Rubigan Shavit	Calixin	Afugan	Milcurb Nimrod	Morestan

To reduce the risk of developing resistance to systemic fungicides, use them strategically, for example:

1. Ensure that spray application equipment is well maintained and properly set up to give good spray coverage.
2. Spray with Morestan at seven to 10 day intervals from planting until early fruit set.
3. After fruit set alternate or tank mix Morestan and a registered systemic fungicide at seven to 10 day intervals. Use a systemic fungicide from at least two of the C, E, F and H groups in rotation.

Note:

- Do not apply Milcurb as a low volume high concentrate spray as it may scorch leaves.
- If applying Milcurb through the trickle irrigation system, spray with a protectant chemical, for example Morestan, as well.
- The manufacturers of some products recommend the addition of wetting agents. Check individual labels for details.
- Afugan is highly toxic to bees. Do not spray if bees are active.

First runners to  
fruit set

### Downy mildew

Use a protectant fungicide for control of downy mildew until weather favours the disease, then use a systemic fungicide. Follow the strategy below to prevent resistance developing to systemic fungicides. Table 15 shows the three groups of fungicides for control of downy mildew.

**Table 15.** The three groups of fungicides for control of downy mildew

Group D (phenylamide)	Group X (unspecified)	Group Y (multi-site activity)
<b>systemics</b>		<b>protectants</b>
Galben M	Acrobat MZ	chlorothalonil
Fruvit		mancozeb
Recoil		propineb
Ridomil MZ		zineb

Use the following strategy to reduce the risk of downy mildew resistance to systemic fungicides.

1. Ensure that spray application equipment is well maintained and properly set up to give good spray coverage.
2. Spray at seven to 14 day intervals with a protectant fungicide from group Y.
3. If it is wet, apply two consecutive systemic sprays from the D or X group in Table 15, then resume applying protectant sprays.

### Bird and animal pests

See Section 3 page 23 for control measures.

### Control weeds

Maintain weed control throughout this stage.

### Nutrition

The application of fertiliser every few weeks without knowing whether the plants need it wastes money and is environmentally irresponsible. Take the guesswork out of fertiliser applications by monitoring plant nutrient levels.

### Plant nutrient monitoring

**Leaf testing** is a benchmarking tool that has little direct relevance to the current crop. Its value is in judging the fertilising schedule used in this crop and how it may be improved for the next crop.

Do a leaf analysis just as the plants start to flower. Buy a tissue sampling kit from your farm supply outlet and follow its instructions. Your results will be interpreted by the laboratory analysing your sample. The optimum leaf nutrient levels for the youngest fully mature leaf with petiole (leaf stem) taken at early flowering are shown in Table 16.

more info



Details in  
Section 3 page 24

First runners to  
fruit set

**Table 16.** Optimum leaf nutrient levels (based on dry weight)

Nutrient	Normal level
Nitrogen (N)	2.5 – 4.5%
Phosphorus (P)	0.3 – 0.7%
Potassium (K)	2.5 – 4.0%
Calcium (Ca)	2.5 – 5.0%
Magnesium (Mg)	0.3 – 1.5%
Sulphur (S)	0.3 – 1.0%
Sodium (Na)	0 – 0.35%
Chloride (Cl)	0 – 1.5%
Copper (Cu)	8 – 20 ppm
Zinc (Zn)	20 – 60 ppm
Manganese (Mn)	60 – 400 ppm
Iron (Fe)	50 – 300 ppm
Boron (B)	30 – 200 ppm
Molybdenum (Mo)	0.5 – 2.0 ppm

Source: Weir and Cresswell, NSW Agriculture, 1993.

**Sap testing** is a means of rapidly assessing a plant’s nutrient status during crop growth. This is a recently developed test for melons and has a 24 hour turn around time. It can be used to highlight deficiencies of any essential element or to monitor the nitrate and potassium levels during the crop cycle. Sap testing allows growers to manage the crop more precisely or to correct any nutrient problems before yield or fruit quality are affected. Sap testing involves collecting leaf stalks (petioles) of the youngest fully expanded leaves, extracting sap with a garlic press, and analysing the nutrient content of the sap.

You can do the tests yourself but we recommend you use a commercial sap testing service which can perform the tests and advise on the results.

Sap testing for nitrogen, phosphorus, potassium, calcium, magnesium and zinc should be done at least every two weeks, and ideally weekly until early fruit set, that is when the first fruit reach golf ball size. Other nutrients should be tested at least three times during the season.

Nitrogen and potassium are the two most easily managed and influential nutrients in melons. Table 17 indicates the optimum range for these nutrients in southern Queensland during this young growth stage (first fruit up to 10 mm diameter).

**Table 17.** Optimum sap levels in southern Queensland for rockmelons with fruit up to 10 mm diameter

Nutrient	Level in parts per million (ppm)
Nitrate	4000 – 6000
Phosphate	70 – 150
Potassium	4000 – 5000
Calcium	200 – 500
Magnesium	250 – 500
Zinc	2 – 5
Copper	1 – 5
Manganese	1 – 7
Iron	1 – 7
Boron	2.5 – 20

Source: John Hall, Crop Tech Research

more info



Sap testing services  
Section 6 page 8

a key issue



Sap testing  
Section 4 page 16

First runners to  
fruit set

### Apply side dressings

Side dressings are applied from early runner stage and should be based on soil or leaf analysis and sap tests. They contain the remainder of the nitrogen and potassium required by the plant. Apply all nitrogen by early fruit set, that is when the first fruit reach golf ball size. Several side dressings may be applied to make up the total requirements. The following are a general guide to side dressing if soil, leaf or sap analysis are not available.

#### **Overhead or furrow irrigated crops**

At the last cultivation, drill in beside the rows a 13:2:14 or similar N:P:K mixture at 200 to 250 kg/ha (720 to 900 g/20 m of row at a 1.8 m row spacing).

#### **OR**

Use a spinner-type fertiliser spreader to apply one or two applications of urea, nitram or potassium nitrate. Total applications should be about 65 kg/ha of urea, 90 kg/ha of nitram or 230 kg/ha of potassium nitrate. Fertiliser should only be 'spun on' when the leaves are dry or it will burn the leaves. The fertiliser should be washed in with overhead irrigation or rain as soon as possible.

#### **Fertilising through irrigation water (fertigation)**

Fertigation has advantages over manual application of solid fertilisers because it uses less labour. With a trickle system fertilisers can be applied more regularly and closer to the roots. Before fertigating get a water testing laboratory to analyse your irrigation water.

With fertigation fertiliser is dissolved in water in a drum or tank and sucked or injected through the watering system. Fertilisers used must be highly soluble to avoid damaging the pump and blocking pipes. Suitable fertilisers are listed in Table 18. There is also a range of soluble commercial fertiliser blends.

**Table 18.** Soluble fertilisers for fertigation

Fertiliser	Main nutrient supplied
Urea	Nitrogen
Calcium nitrate	Nitrogen, calcium
Ammonium nitrate	Nitrogen
Potassium nitrate	Potassium, nitrogen
Potassium chloride	Potassium
MAP (technical grade)	Phosphorus, nitrogen
MKP (mono potassium phosphate)	Phosphorus, potassium

#### **Trickle irrigated crops**

Based on nutrient monitoring, apply fertiliser through the trickle irrigation system. Up to 30 kg/ha of nitrogen and potassium may be needed over this stage. Start applications at early runner and apply

*First runners to fruit set*

the total nutrients required by early fruit set. If soil for leaf analysis or sap tests are not available, use Table 19 as a guide to side dressing applications.

**Table 19. Suggested fertiliser applications through trickle irrigation**

Weeks from planting	Plant stage	Fertiliser rate per hectare
4	Starting to run	12.5 kg potassium nitrate + 20 kg ammonium nitrate
5		12.5 kg potassium nitrate + 20 kg ammonium nitrate
6	Flowering	25 kg potassium nitrate + 30 kg calcium nitrate
7		25 kg potassium nitrate + 30 kg calcium nitrate
8	Fruit to golf ball size	25 kg potassium nitrate

Source: John Hall, Crop Tech Research

### Foliar fertilisers

Foliar fertilisers can be used when plants are under stress from waterlogging, disease or nematodes affecting the roots. Foliar fertilisers help the plants survive until new roots develop and can again support the plant.

### Irrigate

Good irrigation management is essential to produce a good yield of high quality melons. Crops grown without irrigation are generally poor and not economically viable.

If irrigation water is limited use it at the critical times of flowering, fruit set and fruit fill. If plants stress (wilt) for even two or three hours in a day at these times, flowers and young fruit may be shed. Slight wilting is when leaves start to 'droop' in the hottest part of the day. Vigorous varieties with a large root system are less susceptible to stress than less vigorous varieties.

Too much water can pre-dispose plants to sudden wilt complex.

### Irrigation timing

The following suggestions are a guide to water requirements.

**First runners to flowering.** Melons need less frequent but increasing quantities of water as they grow. However, flower set is enhanced by a lack of abundant water.

**Flowering to early fruit set.** This is the most critical period; soil moisture must be maintained or yields will be reduced. Up to three irrigations may be necessary each week, depending on soil type, whether plastic mulch is used, and the weather, such as hot dry winds. Table 20 shows the suggested shallow tensiometer readings for this growth stage.



Irrigation  
Section 4 page 18

First runners to  
fruit set

**Table 20.** Suggested shallow tensiometer readings from the first runners to early fruit set

Soil type	Tensiometer reading	
	First runners to flowering	Flowering to early fruit set
Sany loams	10 – 30	10 – 20
Clay soils	20 – 35	10 – 30

### Train vines

Encourage runners to stay on the plastic mulch so that as much fruit as possible is set on the bed. This will reduce losses from soil rots and damage during harvest.

Pull runners onto the beds by hand once the early runners have started to set fruit.

### Pollination

Rockmelon and honeydew plants produce male and female flowers on the same vine. Only the female flowers will produce fruit. Figure 13 is a diagram of the flowers.



Pollination  
Section 4 page 12

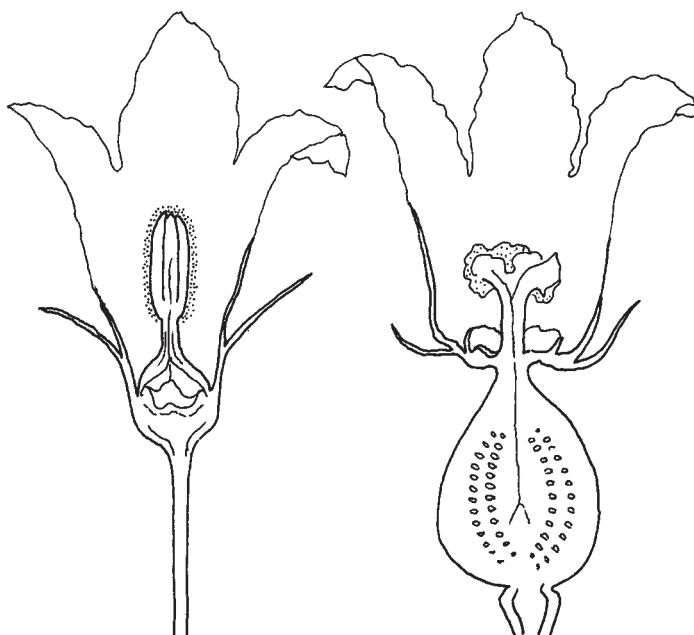

**Figure 13.** Typical male (left) and female (right) cucurbit flowers

Honey bees are the main pollinators of cucurbits. Flowers open early in the morning for one day only and wilt by mid afternoon or earlier in high temperatures. Pollination is usually finished by midday. Poor pollination can cause fruit to set then yellow and fall off. Complete pollination is important to melon size. Fruit with less than 400 seeds do not usually reach commercial size and are often misshapen and slow maturing.



*First runners to  
fruit set*

more info



Chemicals and bees  
*Problem solver handy  
guide*

If there are no bee hives close to the crop, bring hives into the area. Overseas trials suggest that at least two hives per hectare are necessary for pollination, with increased yields from up to four hives per hectare in cold, windy or wet conditions. Beekeepers often lease hives for pollination.

Introduce bee hives when 10% of the crop is in flower to ensure a good crown set and to make sure bees are not distracted by other flowering plants, for example eucalypts. Keep hives in the crop for about three weeks. Destroy flowering weeds.

Apply insecticide and fungicide spray late in the afternoon after bees have returned to the hive. Do not locate hives in the crop where they may be sprayed with chemicals. Use sprays with a low toxicity to bees if possible. If toxic chemicals must be used, remove bees from the crop for at least 24 hours. Give the beekeeper one to two days notice before using toxic chemicals.



## Fruit set to harvest

*This stage usually takes five to seven weeks and is shown in Figure 14. There are four important things to manage during this stage.*

Irrigation.....	35
Manage pests and diseases .....	35
Control weeds .....	36
Nutrition .....	36

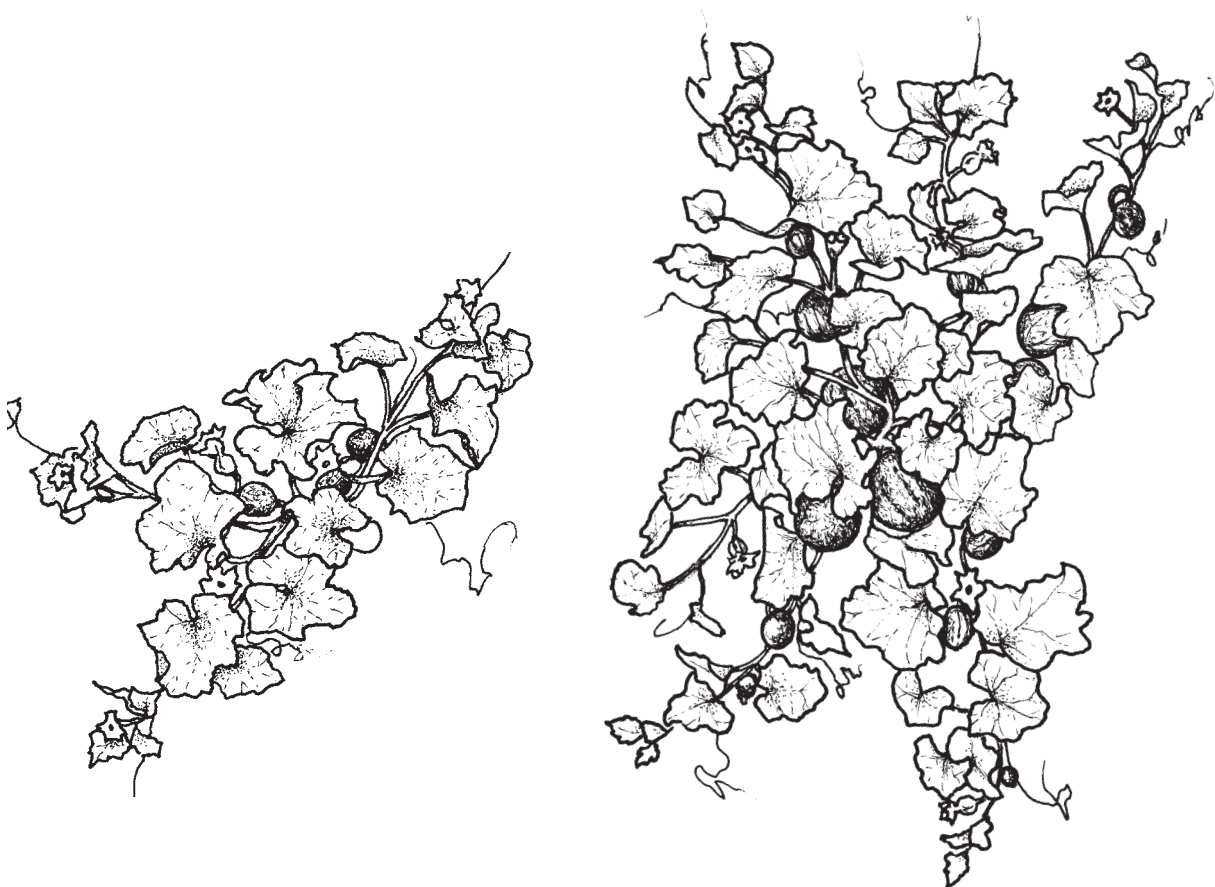

**Figure 14.** Fruit set to harvest



Fruit set  
to harvest

## Irrigation

### Timing

The following suggestions are a guide to water requirements.

**Early fruit development.** Early fruit development is described as the time from fruit set to the appearance of netting on netted varieties. During this critical period soil moisture must be maintained or yields will be reduced. Up to three irrigations may be necessary each week, depending on soil type, whether plastic mulch is used, and the weather, for example hot dry winds.

**Fruit filling to maturity (netting to harvest).** Gradually reduce the amount of irrigation as fruit approach maturity. If plants become too stressed, either from too little or too much water, fruit may sunburn or ripen prematurely. Fruit splitting is common when crops dry out and then receive a lot of water, either through irrigation or rainfall. Irrigate after picking if possible because irrigating before harvest will lower the sugar content of the fruit. Table 21 shows the suggested shallow tensiometer readings for this growth stage.

**Table 21.** Suggested shallow tensiometer readings

Soil type	Tensiometer reading	
	Early fruit development and fruit fill	One week before harvest and during harvest
Sandy loams	10 – 20	25 – 40
Clay soils	10 – 30	35 – 60

Some growers maintain normal irrigation to ensure that developing fruit fill out. This can result in lower Total Soluble Solids (TSS) or sugar content but higher yields.



more info



Fruit problems  
Section 5 *Problem solver*

more info



Other pests  
Section 3 page 23

## Manage pests and diseases

Monitor the crop regularly for powdery and downy mildew and apply an appropriate systemic fungicide if present. Sudden wilt can become a serious problem at this stage.

Monitor for fruit fly. In north Queensland passion vine bug and cucumber moth can also cause problems.

### Disorders

Several disorders affect melons. They include measles, poor netting, suture browning, misshapen fruit, sunburn and fruit cracking.

### Bird and animal pests

Fruit can be damaged by a range of birds and animals including crows, rats or mice, and wild pigs.

Fruit set  
to harvest



Weed control Section 3 page 24

## Control weeds

Weeds should have been controlled by this stage.

## Nutrition

The last of the fertiliser should be applied by early fruit set. Later applications will result in soft, poor quality fruit which may split.

By harvest time plants should be starting to run low on nitrogen and leaves should be paler green, indicating low nitrogen. High nitrogen levels at harvest will result in soft fruit which does not transport well and is more susceptible to fruit rots.

Nitrogen can be applied as a foliar spray if recommended as a result of a sap test. Table 22 shows optimum sap levels for southern Queensland.

**Table 22.** Optimum sap levels in southern Queensland from fruit set to harvest

Nutrient	Optimum level in parts per million (ppm)		
	Fruit set 10 mm – 25 mm	Fruit fill 25 mm– fully netted	Harvest 1 week before & during harvest
Nitrate	3000 – 4000	2500 – 3500	500 – 1500
Phosphate	100 – 250	80 – 250	60 – 200
Potassium	4000 – 5000	4000 – 5000	4000 – 5000
Calcium	300 – 500	300 – 600	500 – 800
Magnesium	300 – 500	300 – 500	300 – 500
Zinc	2 – 5	2 – 5	2 – 5
Copper	1.5 – 5	1.5 – 5	1.5 – 5
Manganese	1.5 – 7	1.5 – 7	1.5 – 7
Iron	1 – 7	1 – 7	1 – 7
Boron	2.5 – 20	2.5 – 20	2.5 – 20

Source: John Hall, Crop Tech Research

Sap nutrient levels for north Queensland should be a little lower than the southern Queensland figures above.

Sap levels can be affected by over or under watering and stressful conditions. Diagnose the cause of the low levels, then apply a suitable nutrient if necessary.



## Harvesting and marketing

*This stage usually takes two to four weeks. The price you receive for your fruit will be decided by how well you manage nine important operations.*

Harvest.....	37
Postharvest handling .....	39
Storage .....	40
Packaging .....	40
Size grade and pack.....	41
Mark packages .....	41
Transport .....	42
Market .....	43
Interstate quarantine requirements .....	44

### Harvest

Ensure pickers know the importance of careful fruit handling. To get the best out of your pickers take time to train and supervise them and provide good working conditions.

Handle melons carefully as they will bruise and split easily. Melons will not increase their sugar content once they have been picked. Almost half of the melon’s sugar content is reputed to be stored in the last week of maturation.

When you start harvesting cut a few melons at the half slip stage to ensure that your assessment of external maturity is accurate. A refractometer can also be used to assess the Total Soluble Solids (TSS) or sugar content of the melons. Immature melons and melons with a low Total Soluble Solids cause a loss of confidence amongst buyers and consumers, and will affect future demand. To maintain a good market reputation it is essential to market only mature melons.

Rockmelons are gently pulled from the vine at the half to full slip stage, while honeydews must be cut off the vine. Harvest carefully to maintain plant leaf cover so that remaining fruit will not sunburn and immature melons will not be force ripened. Harvest at one to three day intervals, depending on temperature. Remove harvested fruit from the field as soon as possible.



Maturity indicators  
Section 3 page 39

## Rockmelons

### *Time from planting to harvest*

The time from planting to harvest for rockmelons varies from 10 to 16 weeks after planting, depending on variety, time of year, district and whether the crop was planted as seeds or transplants. Warm weather encourages earlier crops, while crops grown over winter are slower and may yield less. Harvesting extends over two to four weeks.

### *Yields*

An average yield of good marketable rockmelons is about 1800 trays per hectare but the usual range would be 1000 to 2500 trays. Many higher yields have been recorded. Rockmelons are usually sold in trays which weigh 12 to 18.5 kg.

### *Maturity*

Fruit mature five to seven weeks after setting. Harvest only ripe melons. Fruit that will not pull easily from the stem are immature.

Fruit are mature when the stem will pull away or 'slip' from the fruit with moderate pressure, leaving only a small 'tear' in the stem scar. This is the 'half-slip' stage. 'Full-slip' is when the melon leaves the vine easily without tearing.

Here are other indicators of maturity:

- Rockmelons are well netted with netting showing signs of cracking.
- Skin between the netting changes from dark green to yellow-green.
- Skin on the underside of the melon changes to a creamy yellow.
- Fruit should reach at least 8% Total Soluble Solids to have an acceptable flavour.

### *Grade standards*

Grade standards are no longer in force in Australia. The grade standards which were traditionally used are included below as a guide to the standards expected in the market place.

### *Queensland*

Rockmelons should be of one size, one variety, sound, clean, well-formed, not shrivelled, mature but not over-ripe, and free from sunburn, growth cracks and sponginess. Netting on netted varieties should be smooth and well developed.

'Mature' means the fruit will ripen properly and attain a Total Soluble Solid content of at least 8%.

'One size' means the diameter of the largest rockmelon in the package does not exceed that of the smallest by more than 25 mm.



### **New South Wales**

New South Wales regulations state that a rockmelon is not mature until it has reached at least 'half slip' stage.

### **Honeydew melons**

#### **Time from planting to harvest**

The time from planting to harvest for honeydew melons varies from 10 to 16 weeks after planting, depending on variety, time of year, district, and whether the crop was grown from seed or seedlings. Warm weather encourages earlier crops, while crops grown over winter are slower and may yield less. Harvesting extends over two to four weeks.

#### **Yields**

An average yield of honeydews would be about 2000 trays per hectare but the usual range would be from 1000 to 2500 trays. Good crops will yield much higher than this. Honeydew melons are usually sold in trays which weigh 12 to 16 kg.

#### **Maturity**

Fruit mature five to seven weeks after setting. Harvest only mature fruit. Honeydew melons do not usually 'slip' and should be cut from the vine. Fruit that have slipped are usually over mature. Immature fruit have poor flavour and flesh texture and may break down rapidly. Cut and taste some fruit before harvesting to make sure they are mature.

The following are indicators of fruit maturity for honeydews.

- The waxy coating has gone.
- In white varieties the rind changes colour from greenish white to creamy white or a brighter white depending on variety. In yellow varieties the skin gets brighter.
- The skin is smooth, with few hairs and a lighter background colour.
- If pressed firmly at the flower end the fruit should yield slightly.

#### **Grade standards**

Grade standards are no longer in force in Australia. The grade standards which were traditionally used are included below as a guide to the standards expected in the market place.

Honeydew melons should be clean, sound, fresh, well-formed and of similar varieties.

#### **Postharvest handling**

Place fruit in the shade as soon as possible after harvesting. Force air cool rockmelons to a pulp temperature of 4 to 5°C as soon as possible



Postharvest handling  
Section 4 page 40



after packing to prolong shelf life. Do not cool honeydews below 5°C or fruit will be damaged. Unless forced air cooling is used cooling could take up to 36 hours. Cooled fruit can be held in normal cool rooms. Seek specialist advice before buying a cool room as there are several important design features you need to consider.

### **Fungicide treatment of rockmelons**

Postharvest treatment with fungicides will greatly improve keeping quality of rockmelons and reduce losses from fungal rots. This is not necessary for honeydews.

The treatment, a mixture of benomyl, guazatine and a non-ionic wetter in water, should be applied as soon as possible after harvest. Ensure that fruit is dry before dipping as treating wet fruit is less effective. Heating the fungicide mix to 55°C increases its effectiveness to some extent, but because of the difficulty in maintaining the temperature most growers apply the treatment at ambient (air) temperature. Apply the mix as either a one minute dip, or as a flood spray over rollers. If using a flood spray ensure the fruit is wet for at least one minute.

Dispose of the dip in a way that will not damage the environment.

### **Ethylene ripening of honeydew melons**

Use ethylene to ripen honeydew melons only when:

- there are problems of mixed maturity; or
- a high proportion of fruit does not mature to eating ripe stage within three to four days when held at room temperature.

Most current honeydew hybrids have a concentrated maturity. Provided they are mature when harvested the melons should ripen naturally.

### **Storage**

Rockmelons can be stored for up to two weeks at 3 to 5°C and 90% humidity. Honeydews can be stored for up to four weeks at 7 to 10°C and 90% humidity. Honeydews are sensitive to chilling injury and should not be held below 5°C.

Rockmelons and honeydews produce ethylene and should not be stored or transported with ethylene sensitive produce such as beans, cucumbers, squash, lettuce and zucchini.

### **Packaging**

Rockmelons and honeydews are usually pattern packed into 30 L and 32 L trays and 36 L cartons. These hold 12 to 17 kg, 12 to 18.5 kg and 16 to 22 kg respectively and stack six to a layer on a pallet. Both fibreboard and polystyrene packages may be used.



Postharvest fungicide dips  
Section 4 page 40

Cartons printed with your own brand and colour scheme can be ordered. These make your fruit more identifiable to buyers in the wholesale markets.

## **Size grade and pack**

### **Size gradig**

Melons may e size graded on a grader or by eye. The size relates to the number of melons that can be packed into a package. The most popular size is about eight to nine per tray.

### **Packing**

Top prices are paid for quality produce graded for size. Pack sound, clean melons of similar size, maturity and quality. Pack melons firmly on their sides. Use the package most suited to the size of the fruit and the handling facilities available. If packing more than one layer, place fruit in the pockets made by the lower layer. Figure 15 shows a well packed tray and carton of rockmelons.

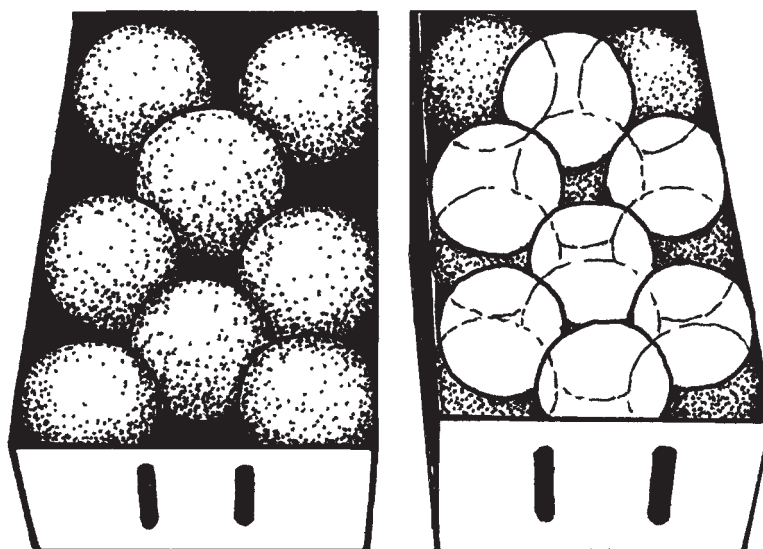

*Figure 15. A well packed tray (left) and carton (right) of rockmelons*

## **Mark packages**

The following information must be shown on the outside of each container in legible, durable lettering not less than 6 mm high:

- name and address, including the state, of the packer;
- the word 'Rockmelon' or 'R-mel' OR the word 'Honeydew' or 'H-dew';
- the count of fruit in each package.

Most melon packages will have a panel with space for you to stamp or stencil your name, address and wholesaler's details. Space for the count will also generally be included for you to tick the appropriate box. An example of the end panel of a tray is shown in Figure 16.

<b>BUNDABERG MELONS</b>																												
<table border="1" style="width: 100%; border-collapse: collapse;"><thead><tr><th style="width: 80%;">VARIETY</th><th style="width: 20%;"></th></tr></thead><tbody><tr><td>Eldorado</td><td></td></tr><tr><td>Hot Shot</td><td style="text-align: center;">✓</td></tr><tr><td>Malibu</td><td></td></tr><tr><td>Meteor</td><td></td></tr><tr><td> </td><td></td></tr><tr><td>Honey Dew</td><td></td></tr></tbody></table>	VARIETY		Eldorado		Hot Shot	✓	Malibu		Meteor				Honey Dew		<p>GROWN &amp; PACKED BY: P.A. &amp; E.T. Imagrower MS 118 Citrus Road BUNDABERG Q 4670</p> <p>PH: (071) 59 0000</p> <p>CONSIGNED TO:</p>	<table border="1" style="width: 100%; border-collapse: collapse;"><thead><tr><th style="width: 80%;">COUNT</th><th style="width: 20%;"></th></tr></thead><tbody><tr><td>12</td><td></td></tr><tr><td>15</td><td style="text-align: center;">✓</td></tr><tr><td>18</td><td></td></tr><tr><td>21</td><td></td></tr><tr><td>24</td><td></td></tr></tbody></table>	COUNT		12		15	✓	18		21		24	
VARIETY																												
Eldorado																												
Hot Shot	✓																											
Malibu																												
Meteor																												
Honey Dew																												
COUNT																												
12																												
15	✓																											
18																												
21																												
24																												
TREATED AND PRE-COOLED	PRODUCE of AUSTRALIA																											

**Figure 16.** End panel labelling for a melon package

### Price look up (PLU) numbers

Price look up (PLU) numbers are commonly used on most products sold through major retail chains. They are being introduced for fruit and vegetables. These numbers assist checkout staff in identifying and correctly pricing products.

Though not of major importance for sales, some high quality or special order melons are individually marked with stickers which include a brand and a PLU number, thus allowing product differentiation at the checkout. Table 23 lists some of the most common rockmelon and honeydew types and their PLU numbers.

**Table 23.** Some common rockmelon and honeydew PLU numbers

	Rockmelon	Honeydew	Honeydew yellow
Large	4050	4034	4327
Medium	4049	4329	5841
Small	5437	5432	5778
Organic	5438		

### Transport

Rockmelons and honeydews are usually transported in refrigerated pantechonicons. Temperature during transport should be between 7°C and 10°C for both melons.

## Market

---

### Domestic markets

Rockmelons and honeydews are usually sold in the Brisbane, Sydney or Melbourne wholesale markets through an agent or merchant. An agent sells produce for a commission, a merchant buys the produce from the grower at an agreed price, then sells it on his or her own account.

Wholesale agents are your source of market intelligence, so your choice of a wholesale agent is extremely important. It is best to deal only with specialist melon wholesalers.

Maintain a good relationship with your wholesalers and keep them informed of the quantities of produce you are consigning and the standard (quality) of the produce.

Major retailing chains are important outlets for melons. Although some of their requirements are met from market supplies, they commonly also buy direct from growers. This is direct selling and is usually on the basis of an agreed pricing system and some form of quality assurance. If possible visit the major market in which your fruit is sold at least once a season.



---

Quality management  
Section 4 page 42

---



---

Prices  
Section 6 page 9

---

### Prices

Prices are closely tied to supply, with higher prices paid during periods of lower production, especially if it coincides with a period of high demand. Demand usually increases during warm weather. Most progressive growers are in daily contact with their wholesaler regarding fruit quality and price.

### Levies

All melons marketed by Queensland growers are subject to a levy under the Queensland Fruit Marketing Organisation Act. The levies are collected so that Queensland Fruit and Vegetable Growers (QFVG) can fund promotion, grower services and research.

### Overseas export

Produce for export must be grown and packed on properties or in premises which have been inspected and have a registered establishment number. The Australian Quarantine and Inspection Services (AQIS) supervises registration of establishments. Quarantine requirements vary between countries and intending exporters should keep informed through local AQIS officers.

## Interstate quarantine requirements

Interstate requirements can change quickly so contact your local DPI plant health inspector or extension officer for the latest requirements. Plant health coordinators in major DPI centres can advise on contacting local DPI inspectors and property freedom requirements. Obtain details of requirements and fulfil these well before sending melons interstate. Table 24 summarises the present interstate quarantine requirements.

**Table 24.** Interstate requirements for rockmelons and honeydews

Code for different states						
QLD	NSW	VIC	SA	TAS	WA	NT
5	5	5	1	1	1,2,3,4	0

Key	Restriction	Requirement
1 2	Melon thrips ( <i>Thrips palmi</i> )	Produce must be certified by an inspector as free of melon thrips. OR Property must be accredited as being more than 100 km from a known outbreak of the pest; i.e. north of Gympie or west of Toowoomba approximately. OR Produce must be fumigated with methyl bromide for two hours at the approved rate and temperature.
3		Produce must be certified by an inspector as free of European red mite. OR Property must be accredited annually as being more than 50 km from a known outbreak of European red mite. In Queensland it is only known to occur on the Granite Belt.
4	European red mite	Produce must be certified by an inspector as receiving an approved postharvest chemical disinfestation treatment. Options include: <ul style="list-style-type: none"> <li>dipped for one minute in 400 mg/L of dimethoate or 412.5 mg/L of fenthion OR</li> <li>flood sprayed with 400 mg/L of dimethoate or 412.5 mg/L of fenthion for at least 10 seconds and remaining wet for at least one minute OR</li> <li>fumigated with methyl bromide for two hours at the approved rate and temperature.</li> </ul>
5	Cucumber fly	The fruit must be free of live insects.
	Insects	Produce from properties located in the papaya fruit fly (PFF) pest quarantine area must receive an approved chemical disinfestation treatment. For areas free from PFF, Tasmania requires certification that the produce was grown in area free from PFF.