

# Cocowood processing manual

## From coconut wood to quality flooring



## **Cocowood processing manual. From coconut wood to quality flooring**

An outcome of ACIAR project FST/2004/054: *Improving value and marketability of coconut wood*.

### **Contributors:**

Henri Bailleres, Gary Hopewell, Adam Redman, Lesley Francis, Johannes Fehrmann, Susan House

### **Cite this publication as:**

Bailleres H, Hopewell G, House S, Redman A, Francis L, and Ferhrmann, J (2010). *Cocowood processing manual. From coconut wood to quality flooring*. Department of Employment, Economic Development and Innovation, Brisbane.

PR10\_4904

© The State of Queensland, Department of Employment, Economic Development and Innovation, 2010.

Except as permitted by the *Copyright Act 1968*, no part of the work may in any form or by any electronic, mechanical, photocopying, recording, or any other means be reproduced, stored in a retrieval system or be broadcast or transmitted without the prior written permission of the Department of Employment, Economic Development and Innovation. The information contained herein is subject to change without notice. The copyright owner shall not be liable for technical or other errors or omissions contained herein. The reader/user accepts all risks and responsibility for losses, damages, costs and other consequences resulting directly or indirectly from using this information.

Enquiries about reproduction, including downloading or printing the web version, should be directed to [ipcu@dpi.qld.gov.au](mailto:ipcu@dpi.qld.gov.au) or telephone +61 7 3225 1398.

# Contents

<b>1. Before you start</b>	<b>1</b>
Acknowledgements	1
Glossary and abbreviations	2
About this manual	3
Managing processing risks	4
Processing cocowood—in brief	5
<b>2. Cocowood processing</b>	<b>11</b>
<b>Cocowood properties and critical processes</b>	<b>11</b>
Harvesting, sorting and handling logs	14
Saw, sort, protect and stack	16
Stacking cocowood	20
Drying cocowood: Overview	25
Drying method 1: Kiln drying	27
Drying method 2: Pre-air drying + final kiln dry	30
Drying method 3: Air drying	31
Grading dry cocowood boards	32
Product specification for export markets	37
Machining and sanding	42
Storing and packing dried boards	43
<b>3. Resources</b>	<b>44</b>
Contacts	44
More information	44

# 1. Before you start

## Acknowledgements

Production of *Cocowood processing manual: From coconut wood to quality flooring* was supported by the Australian Centre for International Agricultural Research (ACIAR) and developed from the knowledge achieved through a three-year research project, *Improving value and marketability of coconut wood* (ACIAR project FST/2004/054). The project was co-funded by ACIAR and the Department of Employment, Economic Development and Innovation (DEEDI), Secretariat of the Pacific Countries (SPC), Ministry of Fisheries and Forests, Fiji, Ministry of Natural Resources, Environment and Meteorology, Samoa, and Strickland Bros Ltd, Samoa.

Henri Bailleres led the cocowood research team, which included Gary Hopewell, Adam Redman, Lesley Francis, Michael Kennedy; students Peter Aeschlimann, Karl Mahnert, Semi Dranibaka, Dario Salzgeber, Raphael Tschupp; and technical staff Bill Atyeo, Eric Littee and Johannes Fehrmann.

The project was supported by valuable experience and enthusiasm from:

Sairusi Bulai and Bale Wikibau (Secretariat of the Pacific Countries, SPC); Sevanaia Tawake (Department of Forestry, Ministry of Fisheries and Forests, Fiji); Tulusina Pouli (Forestry Division, Ministry of Natural Resources, Environment and Meteorology, Samoa); Sosia Joe Strickland (Strickland Brothers Ltd, Samoa); Colin Marley (Sustainable Forest Industries, SFI); Peter Robson (BORAL Timber); Russel Haines and Richard Markham (ACIAR).

The authors also appreciate the comments on earlier drafts by Philippe Chetivet.

The manual could not have been written without the invaluable knowledge and experience gained from the welcoming communities of Fiji and Samoa.

## Glossary and abbreviations

<b>bundle pattern</b>	The combined size and surface area of vascular bundles seen in end-sections of cocowood boards. See vascular bundles
<b>cocowood</b>	Palm stem fibre is referred to as ‘wood’, even though the palm is a herb and not a tree.
<b>Cortex</b>	The ‘bark’ layer of the coconut palm stem.
<b>end-coat</b>	The ends of sample boards are coated with an impermeable coating such as a wax emulsion product or silicon sealant.
<b>EMC</b>	Equilibrium moisture content
<b>grading tool</b>	A chart constructed with pieces of cocowood end-sections of known density and position in the palm stem. The vascular bundle patterns are displayed as a visual cue for grading density in dried cocowood boards.
<b>high density wood</b>	High density fibre (700+ kg/m <sup>3</sup> ) towards the outside of the palm stem, harder material is more suitable for flooring products.
<b>MC</b>	moisture content
<b>MC sample sections</b>	Small sections of wood used to calibrate moisture content using the oven-dry method and sample boards placed in the cocowood stack.
<b>moisture or MC sections</b>	See MC sample sections
<b>m/min</b>	metres per minute
<b>OD</b>	oven-dry
<b>sticks</b>	Strips of seasoned wood that are placed between rows of cocowood at right angles to the length of the boards. They allow air circulation between the layers.
<b>racked (stripped)</b>	Cocowood stack that has been built using rack sticks or strips.
<b>sample boards</b>	Short boards inserted in the drying stack, which are used to assess MC accurately from green to dry.
<b>stack ‘tops’</b>	Pallet material or iron sheeting placed on the top of the cocowood stack to minimise weathering.
<b>stack weights</b>	Concrete weights are needed to minimise distortion in the boards when drying.
<b>stripping</b>	Building a stack of cocowood with rack sticks to separate and space each layer of boards. This allows air flow between the layers, making drying efficient.
<b>vascular bundles</b>	Groups of cells (for transporting water and food) oriented along the length of the palm stem. They are seen in cross-section as patterns of dots on the end-section of boards. They vary in size and concentration and these patterns are correlated with air dry density of cocowood.

## About this manual

This manual describes best practice for producing high-value flooring products from coconut ‘wood’—or cocowood. It meets international standards for flooring products and accounts for the recognised, specific, local conditions of the Pacific Islands.

The information is intended for operators skilled in timber processing, who need to work with the unusual properties of cocowood, and specifies where cocowood processes differ from standard practice for timber. For other processes, refer to the relevant standards set by the importing country.

These technical guidelines are based on the research outcomes of the ACIAR project, *Improving value and marketability of coconut wood*.

The manual is divided into three chapters. Each chapter adds to different aspects of primary and secondary processing, which can be downloaded separately as needed.

Chapter 1 provides an overview of the best practice steps for harvesting and processing cocowood. There is also a glossary of terms specifically associated with processing cocowood and a section on managing processing risks.

Chapter 2 covers cocowood’s unique properties and how they relate to critical processing techniques. This is followed by sections that set out the processing methods in more detail, explaining why these practices are essential when working with cocowood.

Chapter 3 provides more information, including contacts, current timber standards and some useful publications.

## Managing processing risks

The most critical stages of cocowood processing are from sawing to drying the boards.

Cocowood's unique properties expose it to risk from staining organisms after sawing, rapid moisture absorption when kiln dried, and twist while drying.

### Good quality boards suitable for flooring products

- have high density wood fibre and even density distribution throughout the board
- are stain-free
- are dried to the required moisture content without causing degrade—twist (distortion), drying-induced stress, end-splitting or surface-cracking (checking).

### Drying processes are critical

- drying is the most expensive phase of primary processing, representing about 70% of the costs.
- drying is the longest phase, representing about 90% of the processing time.
- drying is the key to controlling wood quality in the final product and so it controls profit margins.

### To minimise risks, always plan to

- transport logs to the processing site within three days of felling.
- saw and grade high density boards, dip (if necessary) and stack boards in a single, essential sequence. Full drying processes will be more successful if the green boards are prepared appropriately.
- kiln dry boards correctly for export markets.
- kiln dry boards with the recommended stack design and drying schedule.
- air dry boards (only suitable for domestic markets) in the recommended stack design.

## Processing cocowood—in brief

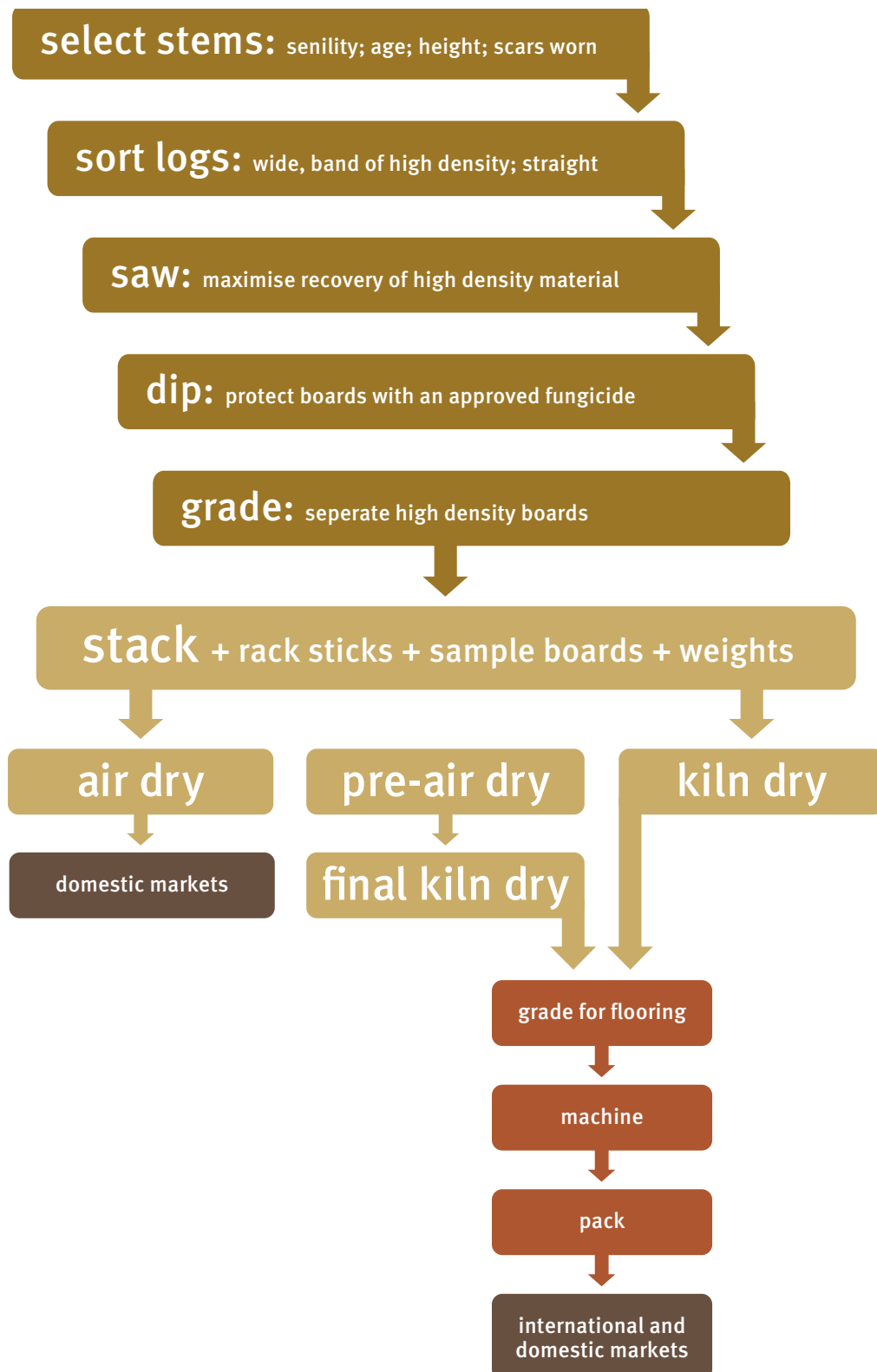



## Harvesting, sorting and handling logs

### Select stems using:

- **stem age**—tall variety stems older than 60 years have a higher proportion of hard fibre.
- **senility**—stems no longer bearing economically viable coconut crops.
- **absence of scars**—scars left by fallen leaves are worn smooth in older trees and hardly visible.
- **height**—older palms are taller and the tall variety palms generally hold more hard fibre.

### Sort and select logs

- select logs that are straight and have a wide, dark band of denser fibre beneath the cortex
- do not store logs in contact with the ground.

### Transport logs

- take logs to the primary processing site within three days of felling.

## Saw, sort, protect and stack

### Steps

1. **Saw** to maximise recovery.
2. Use standard sawmilling equipment but high-speed blades with tungsten-carbide or Stellite-tipped saw blade edges.
3. **Cut parallel** to the outer surface, by raising the thinner end of the log. De-bark and recover the underlying layer of high density wood in 8 sequential cuts in 3, one-quarter turns of the log.
4. **Sort and separate** boards visually, using colour and bundle pattern as a guide to high density fibre.
5. **Dip to protect** against stains and moulds if accelerated drying is not available.
6. **Stack immediately** using the recommended sticker-stack design.

## Stacking cocowood

### Steps

1. **Position** the stack where conditions are suitable or can be moderated.
2. **Build the stack** using dried rack strips (stripping) to space and aerate the boards.
3. **Cut, process and position sample boards** in the stack.
4. **Weight** the stack to minimise distortion during drying.
5. **Protect** the stack or moderate conditions as necessary.

## Drying—overview

### *Export markets and domestic markets using airconditioning:*

- Either kiln dry from green or pre-air dry followed by a final kiln dry.
- Always incorporate correct stacking, using sample boards to monitor changes in moisture content with the oven-dry method.

### *Domestic markets for use in non-airconditioned situations:*

- Either kiln dry from green; pre-air dry followed by final kiln dry or air dry only.
- If an oven and a pan balance are available to monitor moisture content with the oven-dry method, always include sample boards in the stack.

## Kiln drying

### Steps

1. Build the stack with rack sticks, sample boards and weights.
2. Position the stack in the kiln
3. Attain target **moisture content** (MC) for 25 mm thick boards:
  - a. use the **kiln drying schedule** up to 60–65° (dry bulb) over 10–14 days
  - b. **monitor moisture content** using sample boards (for the full MC range) or moisture resistance meters and appropriate correction factors (where sample boards are not used because a suitable oven is not available). Note: resistance meters are only accurate for MC < 25%)
  - c. **equalise** the MC between boards in the stack.

### *Pre-air dry followed by final kiln dry*

### Steps

1. **Build** the stack with rack sticks, sample boards and weights.
2. **Position** the stack where conditions are suitable or can be moderated to optimise drying.
3. **Pre-air dry** the stack of boards (8–11 weeks to reach 17–20% MC)
4. **Monitor moisture content** using sample boards where there is access to:
  - a. an oven heating to 103°C+/- 2°C
  - b. a balance (e.g. top-pan balance).
5. Kiln dry to achieve target moisture content for export flooring products:
  - a. use the kiln drying schedule to optimise drying conditions (6–7 days)
  - b. monitor moisture content using sample boards (for the full MC range) or moisture resistance meters and appropriate correction factors (where sample boards are not used because a suitable oven is not available). Note: resistance meters are only accurate for MC < 25%)
  - c. equalise the MC between boards in the stack.

## Air drying alone

### Steps

1. Position the stack where conditions are suitable or can be moderated to optimise drying. Natural conditions experienced by the stacks can be moderated by changing their position and orientation in the open, or their position in buildings or shelters. Protect stacks from adverse drying conditions by positioning them in the yard or drying buildings using the site drying schedule as a guide.
2. Build the stack incorporating:
  - a. rack strips to space and aerate the boards
  - b. **sample boards** where an oven and balance are available for monitoring MC
  - c. **weights** to minimise distortion during drying.
3. Protect the stack or moderate conditions as necessary:
  - a. use fabric or other shades and screens on the drying building to reduce air flow, if necessary
  - b. place stack ‘tops’ (pallet material or iron sheeting) on the top to minimise weathering in the top layers of stacks that are air drying outdoors; this will be unnecessary if the stack is weighted, because the weight acts as a shield.
4. Monitor moisture content
  - a. using sample boards and the oven-dry method where there is access to an oven (heating to 103°C+/- 2°C), and a balance
  - b. using resistance meters weekly, until 25% MC is reached, then twice-weekly until the target MC is reached
  - c. a final MC of 17–20% can be expected after 8–11 weeks.

## Grading cocowood boards

### Steps

1. Understand the visual grading parameters for cocowood: straightness, bundle pattern, density homogeneity / evenness and straight boards.
2. Become skilled in recognising the relationship between cocowood density, bundle patterns and position in the stem. Graders must be experienced in this.
3. Create a cocowood density grading tool and train graders in visual grading parameters
4. Grade cocowood boards using the density grading tool:
  - a. density—differentiate between dissimilar bundle patterns and associate with cocowood density
  - b. homogeneity—assess density homogeneity within boards (15% variation or less)
  - c. grade and sort boards for appropriate flooring markets.

## Product specification

General	European market	Australian market
Density (air dry):	700 kg/m <sup>3</sup> or greater	700 kg/m <sup>3</sup> or greater
Discolouration: stain or spots	None	
Distortion: bow, twist, cup	As for EN 13226:2009 Wood Flooring - Solid Parquet Elements with Grooves and/or Tongues.  as for EN 13696:2009 Wood Flooring - Test Methods to Determine Elasticity and Resistance to Wear and Impact Resistance	As for AS 2796.1—1999. Australian Standard. Timber—Hardwood—Sawn and milled products. Part 1: Product specification
Moisture content:	All solid wood flooring, 9% (+/- 2%) Parquetry: 9% (+/- 2%) Tongue and groove: 9–12%	Engineered overlay: 9–14% (target 9%) Parquetry: 8–13% (target 9%) Tongue and groove: 9–14% (target 9%)
Colour	High density only: mix lighter and darker shades through the pack	

Product dimensions	European market	Australian market
Engineered overlay flooring	Manufacture a 15 mm overlay board from a laminated beam constructed from 8, 20 mm thick boards that are glued to 12 mm plywood.	Manufacture a 15 mm overlay board from a laminated beam constructed from 8, 20 mm thick boards that are glued to 12 mm plywood.
Tongue and groove	As for EN 13226:2009 Wood Flooring - Solid Parquet Elements with Grooves and/or Tongues: common dimensions - 15 x 90 x 450/990 mm 15 x 100 x 500/800/1000/12000/ 1500/2000 mm	As for AS 2796.1—1999. Australian Standard. Timber—Hardwood—Sawn and milled products. Part 1: Product specification
Parquetry	As for EN 13226:2009 Wood Flooring - Solid Parquet Elements with Grooves and/or Tongues: common dimensions - Piece: 16 x 22 x 160 mm, surfaced 2 sides Bundle: 2x (16 pieces),	As for AS 2796.1—1999. Australian Standard. Timber—Hardwood—Sawn and milled products. Part 1: Product specification

## Machining and sanding

- **Tungsten-carbide** tool edges provide the best results at feed-speeds of 12 metres per minute (m/min).
- Tools made from **cobalt-base alloys** strengthened with tungsten and molybdenum (known as stellite alloys) give a better quality result at higher speeds, such as 24 m/min.
- **For mouldings**, lower feed speeds are recommended to reduce the risk of torn grain and soft tissue roughness, which are more likely at higher feed-speeds.
- **When profiling**, for example when producing a tongue and grooved profile, lower feed speeds are recommended. Tear-out occurs where bundles meet the surface at an angle rather than align parallel to the surface.
- If the material is **prone to rough grain or soft tissue**, use lower feed speeds.
- **Cross-cutting** negative cutting angle blades and positive cutting angle blades also provide good results.
- **Rip sawing** straight blades provided a better result than bevelled blades, where the board is cut longitudinally. Straight blades produce fewer splinters and tear-out.
- **Sand** to a smooth finish at 12 m/min.

## Storing and packing boards

- Maintain the cocowood in optimal conditions while it is stored; avoid more than 1% variation in moisture content.
- Ensure that the moisture content is appropriate when it is received or dispatched.
- Protect the boards during storage and transport by wrapping individual packs in plastic.

## 2. Cocowood processing

### Cocowood properties and critical processes

	Unique properties	Critical processes
	<p>Density variation in cross-section</p> <ul style="list-style-type: none"> <li>• A outer cortex / 'bark'</li> <li>• B hard: &gt;700 kg/m<sup>3</sup></li> <li>• C medium: 500–700 kg/m<sup>3</sup></li> <li>• D low: &lt;500 kg/m<sup>3</sup></li> </ul>	<ul style="list-style-type: none"> <li>• Select trees that are older, taller and straighter</li> <li>• Select / sort logs with wider, dark band of denser fibre beneath the cortex.</li> </ul>
	<p><b>Variation in quality</b></p> <ul style="list-style-type: none"> <li>• High density boards are suitable for flooring products in international markets.</li> <li>• Medium density boards are suitable for local markets.</li> <li>• Low density material may be used in secondary products such as a plant growing substrate.</li> </ul>	<ul style="list-style-type: none"> <li>• Cutting pattern–The first 8 cuts de-bark and produce the high density wood.</li> <li>• Raise the log-end to keep the cut parallel to the outer surface.</li> <li>• Grade each board and stack high density boards separately.</li> </ul>
	<ul style="list-style-type: none"> <li>• Green boards are very susceptible to staining caused by micro-organisms.</li> </ul>	<ul style="list-style-type: none"> <li>• Dip boards in an approved fungicide chemical immediately after cutting.</li> <li>• Air dry quickly.</li> <li>• Avoid direct contact with the ground.</li> <li>• Stack correctly using rack sticks to separate boards.</li> </ul>
	<ul style="list-style-type: none"> <li>• Enhanced spiral grain makes the boards liable to twist degrade.</li> <li>• Cocowood fibre is highly hygroscopic (it absorbs water readily).</li> <li>• Distortion can be exacerbated by variation in density and grain alignment within a small cross-sectional area.</li> </ul>	<ul style="list-style-type: none"> <li>• Stack immediately after cutting and dipping.</li> <li>• Use rack sticks to build the drying stack.</li> <li>• Use sample boards to monitor moisture content.</li> <li>• Weight the stack.</li> <li>• Saw to achieve similar density throughout each board</li> <li>• Follow the drying schedule for cocowood.</li> </ul>
 <p><i>Image courtesy Planet Coconut</i></p>	<p><b>Flooring products:</b></p> <ul style="list-style-type: none"> <li>• Wide cover widths machined from a single piece (especially 133 mm or 5¼ inch) can shrink and expand unacceptably in service with changing environmental conditions.</li> </ul>	<ul style="list-style-type: none"> <li>• For a 15 mm overlay product: construct the recommended engineered overlay product from a laminated beam, re-sawn.</li> <li>• For T&amp;G and parquetry, follow specifications for Australian and European markets.</li> </ul>

Physical properties (units)	Range = low–high density fibre
Density - basic (kg/m <sup>3</sup> )	100–1020 <sup>a</sup>
Density - air dry (kg/m <sup>3</sup> )	200–1170 <sup>a</sup>
Density for flooring products (Janka hardness >7kN) (kg/m <sup>3</sup> ):	>700 <sup>a</sup>
Specific gravity	0.26–0.59 <sup>d</sup>
Shrinkage: tangential, green to dry (%)	3.0–6.0 <sup>b,c,d</sup>
Shrinkage: radial, green to dry (%)	2.7–7.4 <sup>b,c,d</sup>
Unit shrinkage: tangential	0.05–0.42   high density: 0.32–0.38 <sup>a</sup>
Unit shrinkage: radial	0.05–0.34   high density: 0.24–0.3 <sup>a</sup>
Workability	Firm to hard; use sharp tools

Mechanical properties (units)	Range = low–high density fibre
Modulus of elasticity: dry (GPa)	2–25 <sup>a</sup>   high density: 11.4 <sup>c</sup>
Modulus of rupture: dry (GPa)	28–205 <sup>a</sup>   high density: 104 <sup>c</sup>
Maximum crushing strength: dry (MPa)	19–57 <sup>c</sup>   high density: 40 <sup>c</sup>
Janka hardness: dry (kN)	0.7–23.9 <sup>a</sup>

Chemical properties (units)	Range = low–high density fibre
Inorganic pure ash (%)	0.75 (0.25–2.4) <sup>a</sup>
Silica (%)	0.07 (0.01–0.2) <sup>a</sup>
Lignin (%)	25.1 <sup>d</sup>
Holocellulose (%)	66.7 <sup>d</sup>
Pentosans (%)	22.9 <sup>d</sup>
Starch (%)	4.3–4.6 <sup>e</sup> (>6 months old; starch reduces with age)
pH	6.2 <sup>e</sup>

Durability, susceptibility to pests and staining	Range = low–high density fibre
Natural durability above-ground (averaged over all densities)	Class 4; life expectancy 0–7 years <sup>f</sup>
Natural durability in-ground (averaged over all densities)	Class 4; life expectancy 0–5 years <sup>f</sup>
Susceptibility to Lyctus	Not susceptible <sup>b,f</sup>
Termite resistance (averaged over all densities)	Not resistant <sup>a</sup>
Staining	Susceptible to staining <sup>b</sup>

<sup>a</sup> Department of Employment, Economic Development and Innovation (DEEDI), Brisbane, Australia. Unpublished data: Improving the value and marketability of coconut wood. ACIAR project No. FST/2004/054

<sup>b</sup> Alston, AS (1982) Timbers of Fiji, properties and potential uses. Department of Forestry, Suva, Fiji.

<sup>c</sup> Arancon, RNJ (1997) Asia-Pacific Forestry: Focus on Coconut Wood. Paper No. APFSOS/WP/23. FAO, United Nations, Rome.

<sup>d</sup> Gibe, ZC (1985) The Philippines' recommendations for coconut timber utilisation. Philippine Coconut Authority. PCARRD, Philippines.

<sup>e</sup> Poulter, R & Hopewell, G (2010) Secondary cocowood products. Potting mix. (DEEDI), Brisbane, Australia.

<sup>f</sup> Keating, W & Bolza, E (1982) Characteristics, properties and uses of timbers. South-east Asia, Northern Australia and the Pacific. Inkata Press.

**Kiln drying schedule: up to 60–65° C (dry bulb) over 10–14 days.**

Moisture content change points (%)	Dry bulb temperature (° C)	Wet bulb temperature (° C)	Relative humidity (%)	Equilibrium moisture content (%)
Green – 85	49.0	44.0	78.0	13.0
85 – 58	53.0	47.0	75.0	11.5
58 – 35	56.0	48.0	64.0	10.0
35 – 28	58.0	49.0	51.0	9.0
28 – 19	62.0	48.0	43.0	6.5
19 – 12	60.0	43.0	40.0	5.5
Equalisation – 48 hrs	60.0	55.0	55.0	8.0

**Monitoring moisture content MC.** Recommended: use sample boards in the stack and the oven-dry method for monitoring MC during drying. Or, use resistance type meters (accurate only at MC <25%) and moisture correction factors provided: **Moisture correction factors for kiln drying cocowood** (for resistance meters calibrated to *Pseudotsuga menziesii*)

Meter reading (% moisture)																		
6	7	8	9	10	11	12	13	14	15	16	17	18	19	20	21	22	23	24
Corrected moisture content (% moisture)																		
–	–	–	–	8	8	9	9	10	11	11	12	12	13	13	13	14	14	15



# Harvesting, sorting and handling logs

## Steps

5. Select stems using:
  - a. **stem age**—tall variety stems older than 60 years have a higher proportion of hard fibre.
  - b. **senility**—stems no longer bearing economically viable coconut crops.
  - c. **absence of scars**— scars left by fallen leaves are worn smooth in older trees and hardly visible.
  - d. **height**—older palms are taller and the tall variety palms generally hold more hard fibre.
6. Sort and select logs that are straight and have a wide, dark band of denser fibre beneath the cortex
7. Do not store logs in contact with the ground.
8. Transport logs to the primary processing site within three days of felling.

## Selecting suitable stems

The variation in palm ‘wood’ quality means that it is important to identify the stems that are most likely to contain a high proportion of high density ‘wood’ (or hard fibre), as far as possible. Sometimes old coconut plantations contain some younger palms that were planted more recently after wind or storm damage. These stems will have a smaller proportion of hard material. The criteria used for selecting stems are:

- **stem age**— tall variety stems older than 60 years have a higher proportion of hard fibre.
- **stems no longer bearing** economically viable coconut crops— these are usually older trees.
- **absence of scars** on the stem: —scars left by fallen leaves are worn smooth in older trees and hardly visible.
- **height**—older palms are taller and the tall variety palms generally hold more hard fibre.

## Harvesting

Felling and removing the coconut palm is similar to operations for plantation timber trees. Standard chainsaw equipment and tree-felling techniques used for forest trees are also used for coconut palms. Tractors used for snigging the palm logs to the loading site are the same as those used in timber harvesting operations.

### Personal protective equipment is strongly recommended:

- earmuffs or earplugs
- helmet or hard hat
- eye protection
- gloves
- chaps
- safety boots.

## Sorting logs

On a cut stem, the high density wood is visible as a dark band inside the bark. Stems with more high density wood can be identified at this stage.

Logs are also selected for straightness because straighter stems recover longer boards.

Suitable logs are usually cut from 0.5 to 12–13 metres in the stem; rarely extending to 15 metres.

Until dry, cocowood is susceptible to staining caused by micro-organisms, which can easily enter the moist cocowood fibre of cut logs. This means it is critically important to minimise this risk by transporting the logs to the processing site within three days of felling.

Logs should be stored for a very short time only and processed as quickly as possible. The maximum transport time between plantation and processing plant for unprotected logs is three days.

Never store logs in contact with the ground.

Spraying is not appropriate because it is relatively ineffective and potentially a risk to the environment.

Time the stem harvesting to coincide with timely processing. If delays are anticipated, post-poned felling rather than store logs.



A senile coconut plantation



Felling a palm



A dark band of high density wood



Straight coconut stem

## Saw, sort, protect and stack

Boards must be sawn, dipped with an anti-stain solution (where necessary) and stacked in quick succession. This will minimise the risk of staining and twisting during drying.

### Steps

1. **Saw** to maximise recovery.
2. Use standard sawmilling **equipment** but high speed blades with tungsten-carbide or Stellite-tipped saw blade edges.
3. Cut **parallel** to the outer surface, by raising the thinner end of the log. Debark and recover the underlying layer of high density wood in 8 sequential cuts in 3, one-quarter turns of the log.
4. **Sort and separate** boards visually, using colour and bundle density as a guide to high density fibre.
5. **Dip** (if accelerated or kiln drying is not available) to protect against stains and moulds.
6. **Stack immediately**, using the recommended sticker-stack design.

### 1. Sawing recovery

The aim is to maximise recovery of high density cocowood fibre, which occurs towards the outer periphery of the logs. Usually, four high density boards can be cut from each palm stem billet. Boards that have a relatively homogenous density and straight grain are suitable for high value flooring products. Boards containing marked density gradients and spiral grain are prone to degrade, especially twist, during drying. Suitable material occurs up to about 12–13 metres in the senile palm stem.

### 2. Equipment

Coconut palm stems can be sawn using standard hardwood sawmilling equipment. The high mineral content (2–3%) and the variation in grain angle caused by the structure of the vascular bundles means that sharp, high speed steel (HSS) blades, tungsten-carbide or Stellite-tipped saw blade edges are most appropriate for processing cocowood. Regular sharpening intervals are recommended when breaking down logs.

### 3. Cutting pattern

Remove the cortex ('bark') layer carefully to avoid wasting the narrow band of high density wood underneath. Unlike the bark tissue in normal timbers, the cortex of coconut palms is inter-grown with the outer, peripheral fibre, and it is relatively difficult to separate with hand tools. This means that it should be sawn off.

Set the saw to cut **parallel to the external surface** of the log to ensure that the board has a consistent density profile from one end to the other. If necessary, raise the small diameter end of the log so the cut remains parallel along its whole length.

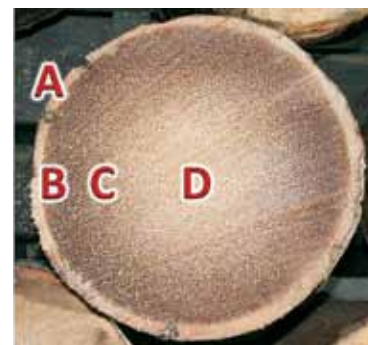

Distribution of fibre density



Cutting pattern

If a board has high density fibre at one end, gradually changing along its length to low density at the other end, the board will be at high risk of distorting during drying and in service.

**A typical cutting pattern for maximum recovery:**

- **Cut 1** – de-bark
- **Cut 2** – cut parallel to cut 1, taking the high density wood, board 1.
  - **Turn** log one quarter turn.
- **Cut 3** – de-bark
- **Cut 4** – cut parallel to cut 3, taking the high density wood, board 2.
  - **Turn** log one quarter turn. **Cut 5** – de-bark
- **Cut 6** – cut parallel to cut 3, taking the high density wood, board 3.
  - **Turn** log one quarter turn.
- **Cut 7** – de-bark
- **Cut 8** – cut parallel to cut 3, taking the high density wood, board 4.

Cut the next, medium density boards for local markets.



De-bark



Cut 2 to produce board 1



Board 2 removed, ready to turn



Cut 6, board 3



Cut 7, de-bark board 4



High density boards removed



Fixed band-saw; cut 3 completed



Fixed band-saw; high density boards removed

## 4. Sort green, off-saw

Green, off-saw sorting is done by a visual assessment of the colour and bundle density of the board. Separate the high density boards, which are suitable for flooring, from the medium and low density material.

## 5. Dip to protect sawn boards against stain and moulds

Will accelerated (kiln) drying immediately follow sawing?

- Yes – stack immediately, using the recommended sticker-stack design.
- No – boards must be treated with a stain control solution if accelerated drying facilities are not available, or if boards are cut far from processing facilities.

Rapid drying can prevent or minimise fungal staining. Leaving sawn boards in humid conditions will increase the risk.

### Stain control treatment

Boards should be dipped immediately after sawing for ten seconds in an appropriate treatment solution. Contact agricultural chemical suppliers and local regulatory authorities to determine which stain control treatments are approved. Research suggests a solution of a treatment containing chlorothalonil (450g/L) and carbendazim (100g/L) is effective for minimising staining.

Stain control treatments must be used safely and as prescribed by the manufacturer. Avoid environmental contamination.

**Note:** Boards should never be in contact with the ground or in direct sunlight, either before or after dipping.

### Making up fungicide solutions

Water (litres)	2% anti-stain (litres)
1	0.02 (20 mL)
4.9	0.1 (100 mL)
9.8	0.2 (200 mL)
14.7	0.3 (300 mL)
19.6	0.4 (400 mL)

#### Safety first

**Always** use and handle treatment solutions as directed by the manufacturer.

**Always** avoid direct contact with the treatment.

**Always wear** gloves, eye protection, foot protection and an apron.

**Always have nearby** a wash down station, a hose or a bucket of water in more remote areas.



Dipping a board in a fungicide solution



Draining boards before stacking

## 6. Stack

Stack immediately as described fully in Section 5.

### Sticker-stacking—a quick reference:

- Stacks should be 400 mm clear off the ground on bearers.
- Full length boards are positioned on outside rows, and bottom and top layers.
- Board ends are supported.
- Dried rack sticks 20 mm (thick) x 30 mm (wide) must be vertically aligned and spaced 450 mm apart.
- Weights should be placed on top of the pack to minimise distortion during drying.
- Accelerated drying in a kiln is recommended to minimise the chance of staining and moulds growing in the wood.
- 



## Stacking cocowood

Correct stacking is essential for cocowood because it influences all the successive stages of the drying process. The stack design must minimise the risk of twist, end distortion, and uneven drying.

The shape and arrangement of the stack controls:

- how well individual boards are restrained
- the quality and quantity of the airflow between the rows of cocowood boards
- how effectively boards dry
- the quality and efficiency of pre-driers and kilns.

**Always build a sticker-stack;** it is designed to allow air-flow through the stack, removing moisture, and support and restrain boards to avoid twist and end-distortion. It is the basic handling element for storing, transporting and drying cocowood boards.

**Always incorporate sample boards in the stack;** these will be used to gauge moisture content values that fall outside the range measured by electrical moisture meters. Resistance-type moisture meters are inaccurate above 25% MC. Below 25% MC, resistance-type moisture meters can be used with appropriate correction factors.

### Storing and transporting boards before drying

Always dip and sticker stack for storing short-term and transporting green boards to a processing centre. Add weights to the stack if the delay in transport will be more than 2 weeks.

### Correct stacking is essential for successful drying

For international flooring markets, the stack must incorporate rack sticks and sample boards to monitor MC accurately. This also applies to cocowood boards bound for any domestic or local situations that will be airconditioned.

The only exceptions are for local, non-airconditioned markets and where a kiln is unavailable or the oven-dry method is not available for monitoring MC.

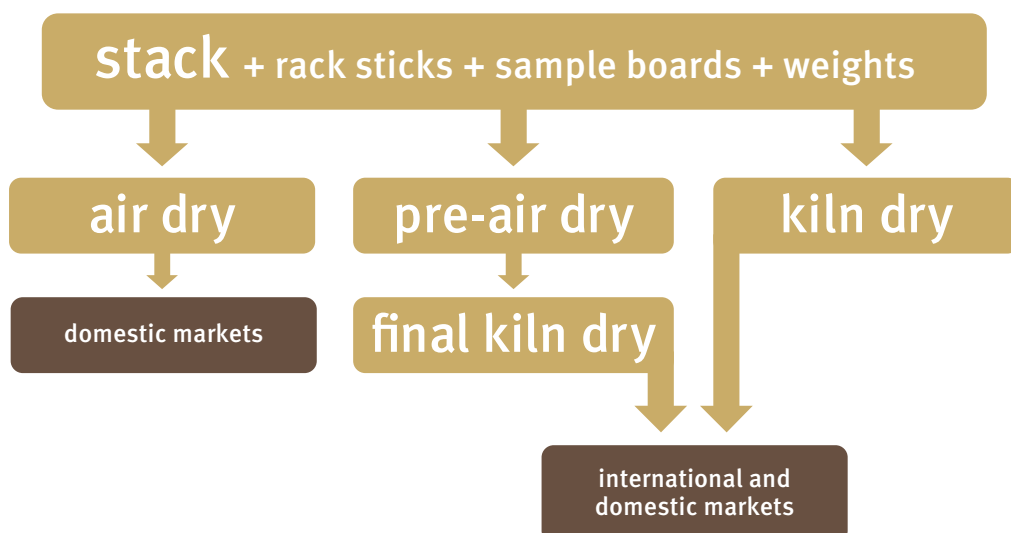

## Steps

1. **Position** the stack where conditions are suitable or can be moderated.
2. **Build the stack** using dried rack strips (stripping) to space and aerate the boards.
3. **Cut, process and position sample boards** in the stack.
4. **Weight** the stack to minimise distortion during drying.
5. **Protect** the stack or moderate conditions as necessary.

## 1. Position the stack to moderate conditions affecting the stacks

Natural conditions experienced by the stacks can be moderated by changing their position and orientation in the open, or their position in buildings or shelters. Protect stacks from adverse drying conditions by:

- positioning them in the yard or drying buildings, using the site drying schedule as a guide
- using fabric or other shades and screens on the drying building to reduce air flow
- placing stack ‘tops’ (pallet material or iron sheeting) on the top to minimise weathering in the top layers of stacks that are air-drying outdoors; this is unnecessary if the stack is weighted because the weight serves as a natural stack ‘top’.

## 2. Build the stack using rack sticks

Build the cocowood stack so that each layer of boards is separated and spaced for drying with rack sticks, a process called stripping.

### Quick reference

- Stacks should be 400 mm clear off the ground on bearers.
- Use dried rack sticks 20 mm (thick) x 30 mm (wide) to separate the boards.
- Rack sticks are spaced 450 mm apart between rows of cocowood at right angles to the length of the boards
- Full-length boards are positioned on outside rows, and bottom and top layers.
- Shorter boards should be arranged in the centre of rows and aligned at each end of the rack
- Board ends are supported.
- Boards should not overhang the last, outside rack stick by more than 50 mm.

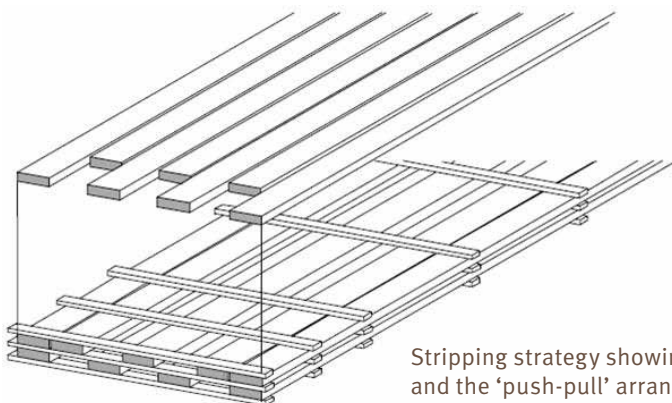

Stripping strategy showing the rack sticks and the ‘push-pull’ arrangement



## Reasons to stack properly

Spacing the boards allows air to flow, removing moisture, and ensures the boards dry evenly to a suitable moisture content with minimal degrade.

Assembling the rack is one of the most important stages of drying cocowood because the stack is the unit handled through all the remaining stages of drying. Any mistake made in the way cocowood is stripped results in problems with that material throughout the remaining stages.

The ideal, finished cocowood stack has boards:

- of similar thickness, density and drying characteristics
- restrained and supported evenly along their full length and at both ends
- spaced at regular intervals from boards in adjacent rows
- assembled with very even sides and ends so that the airflow into the rack from any direction is as regular as possible
- arranged so that the rack is sturdy and its size complements other, fixed equipment.

## Position the rack sticks

**Rack sticks** are strips of seasoned wood placed between rows of cocowood at right angles to the length of the boards. They allow air circulation between the layers. Rack sticks are approximately 20 mm thick and 30-40 mm wide. Narrower sticks tend to create indentations in the boards above and below, and wider sticks can delay drying and cause staining in the contact area.

**Spacing rack sticks** depends on the thickness and length of the boards.

### Maximum spacing for rack sticks (units in mm)

Board thickness	25 mm or more	less than 25 mm
Inner rack spacing	450	350
End spacing	300	250

## Arrange the boards

Arrange the boards close together in the row. As each layer of cocowood is placed, keep alternate boards in alternate rows flush with alternate ends. This gives a checkerboard arrangement at the ends of the rack and is called 'push-pull' racking.

Boards should not overhang the last, outside rack stick by more than 50 mm. Overhanging ends dry rapidly and may split. Board ends shouldn't overhang internal rack sticks too much for the same reason.

Arrange short boards to match the regular position of rack end lengths. Their inside ends should either be butted together to share a single stick, or moved apart entirely, so that they are firmly supported on separate sticks.

The full length boards on the base and at the sides provide a consistent airflow path and structural support for the rack. The alternating ends of the boards provide a relatively regular end to the rack.

The full length of the board and the ends need to be restrained evenly so that they dry flat and straight. As the boards dry, they tend to distort, especially the ends. In the stack, boards are restrained by the weight of boards above them, supported by rack sticks. A thicker board is more rigid between points of restraint than thinner boards.

### 3. Sample boards

Sample boards are needed to monitor MC changes in the stack, by weighing. Small **moisture or MC sections** are cut from the sample boards to be a reference for the starting MC levels.

- Cut and label sample boards.
- Cut and label small MC sample sections.
- Weigh sample boards using a top-pan balance.
- End-coat sample boards
- Place sample boards in the stack. They will be weighed during the drying process.

**Cut and label sample boards.** For each stripped stack, at least two sample boards should be used; one each side of the stack. Sample boards should be chosen from high density boards (free of bark) before stripping. Sample boards should be cut as shown and about 400 mm long or shorter so that they can be weighed easily with the available top-pan balance. Label sample boards with a unique number and ending with 'S'.

**Cut and label small MC sample sections.** At the end of each sample board remove two small MC sample sections as soon as possible. These will be oven-dried to calculate the original moisture content of the boards. Label the moisture content sections with the same sample board number followed by 'A' for one section and 'B' for the other.

**Weigh sample boards.** Weigh the sample boards immediately, and then wrap each board fully with 3-4 layers of plastic film and store, ready to place in the stack.

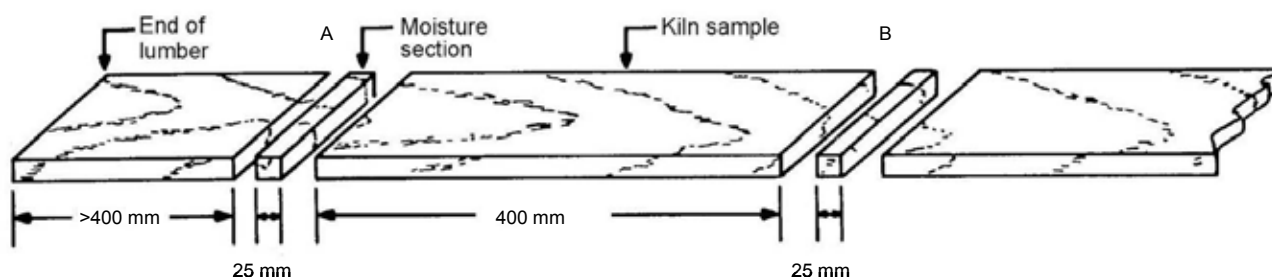

How to cut sample boards.

**End-coat sample boards.** Because cocowood dries most quickly through the end grain, the end grain in the sample boards must be sealed, so that they represent how a long board would dry more accurately. An impermeable coating such as a wax emulsion product or silicon sealant is recommended.

**Place sample boards in the stack.** Place the sample boards in 'sample pockets' in the stack.

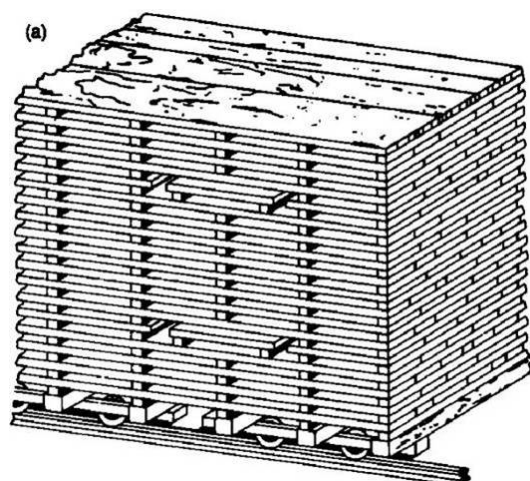

A cocowood stack showing rack strips and the position of the shorter sample boards.

## 4. Weight the stack

Cocowood is particularly prone to twist distortion during drying, so placing concrete weights on the top of kiln stacks is recommended. A minimum mass of 1000 kg weight per 1 m<sup>2</sup> surface area is suggested.

Stacks must be weighted during full air-drying and when there is a two week delay in moving green boards to a processing centre.

## 5. Protect the stack

Stacks stored in the green or drying mill, or during transport, should be protected to minimise end drying and checking. Store the stacks in a protected location, ideally in an enclosed building.

- Support stacks on evenly-spaced bearers placed immediately under a line of rack sticks.
- Use fabric or other shades and screens on the drying building to reduce air flow.
- Place stack 'tops' (pallet material or iron sheeting) on the top to minimise weathering in the top layers of stacks that are air-drying outdoors.



Cocowood stack showing sample boards



Twisted boards in an un-weighted stack

## Drying cocowood: Overview

***Drying = stacking correctly + kiln drying or (pre-air + kiln drying) or air drying.***

Cocowood boards must be dried adequately before they are profiled for solid flooring or manufactured into engineered flooring products. Drying reduces the moisture content (MC) of boards to meet market demands for flooring products.

**Target moisture content** for flooring products destined for export markets are:

- Australia 9–14%
- Europe 7–11%

**Kiln drying** is an accelerated drying process, incorporating an accurate determination of the end-point moisture content. Kiln drying is appropriate for export and domestic markets.

**Pre-air drying, followed by final kiln drying** may be appropriate when the sawing plant is remote from kiln facilities. Cocowood boards must finish drying in a kiln if they are intended for export or airconditioned situations in local markets.

**Air drying is not suitable for international flooring markets.** Air-drying in tropical environments can only achieve moisture contents between 15% and 18% because of the ambient conditions. Also, if flooring is to be produced for the domestic markets in airconditioned environment, it is also necessary to lower the final MC by kiln drying.

## Drying methods match the market

***Cocowood for export markets and airconditioned use in domestic markets:***

- Either kiln dry from green or pre-air dry, followed by a final kiln dry.
- Always stack correctly, using rack sticks, and sample boards to monitor changes in moisture content with the oven-dry method.

***Cocowood for domestic markets in non-airconditioned situations:***

- Either kiln dry from green; pre-air dry followed by final kiln dry or air dry only.
- If an oven and a pan balance are available to monitor moisture content with the oven-dry method, always include sample boards in the stack.

This decision tree overleaf clarifies the options.

Drying best-practice decision tree

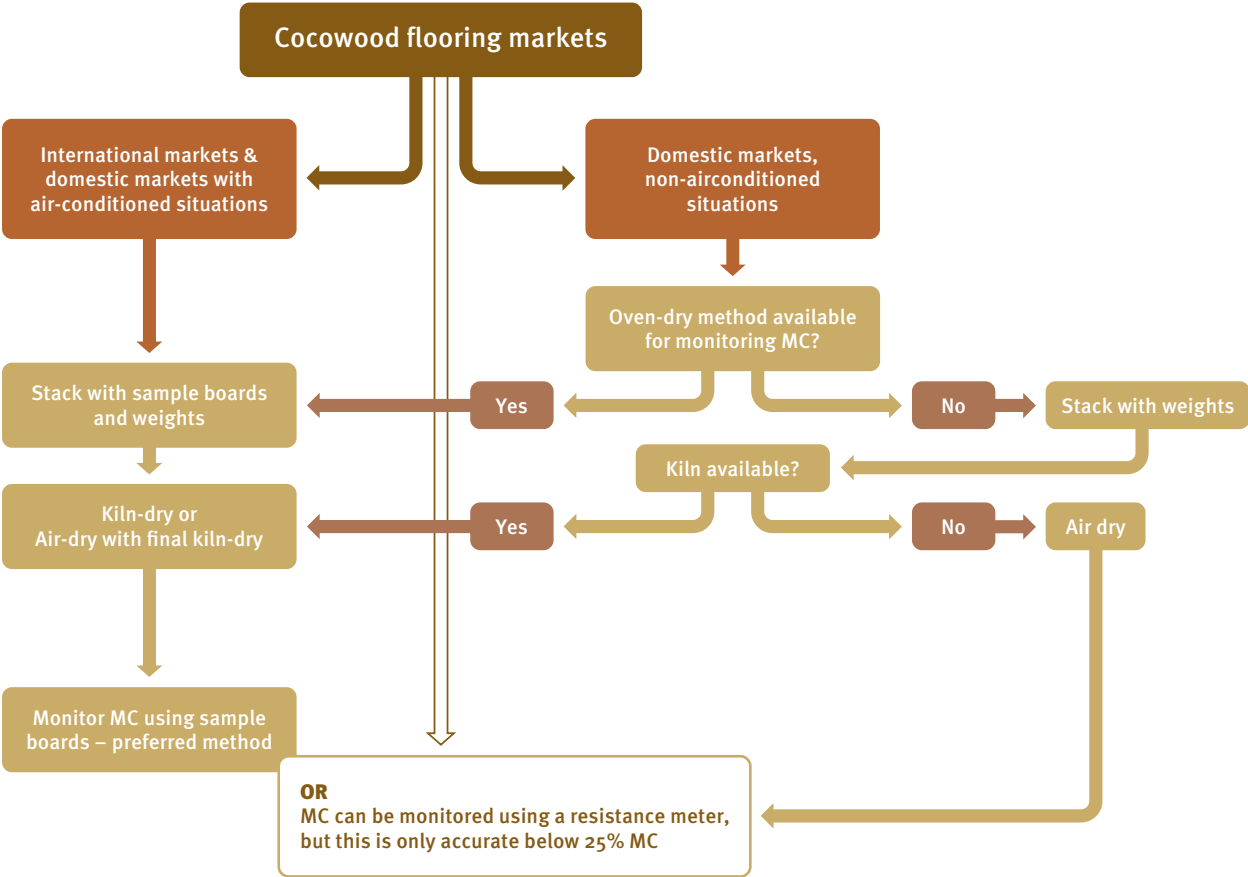

## Drying method 1: Kiln drying

Kiln drying is accurate and rapid, minimising the amount of degrade in the stack. Being able to control drying conditions makes it possible to achieve specific moisture contents that are suitable for engineered flooring products.

### Steps

1. Build the stack with rack sticks, sample boards and weights.
2. Position the stack in the kiln
3. Attain target **moisture content** (MC) for 25 mm thick boards:
  - a. use the **kiln drying schedule**: up to 60–65° (dry bulb) over 10–14 days:
  - b. **monitor moisture content** using sample boards (for the full MC range) or moisture resistance meters and appropriate correction factors (where sample boards are not used because a suitable oven is not available). Note: resistance meters are only accurate for MC < 25%).
  - c. **equalise** the MC between boards in the stack.

## Kiln drying schedule

Cocowood can be kiln dried up to 60–65°C (dry bulb) over 10–14 days for 25 mm thick material, depending on the equipment. Concrete weights should be used during drying to minimise distortion.

Drying rate is affected by board thickness, initial moisture content, weather conditions, stacking method, density and drying method.

### Drying schedule for 25 mm cocowood boards (recommended)

Moisture content change points (%)	Dry bulb temperature (° C)	Wet bulb temperature (° C)	Relative humidity (%)	Equilibrium moisture content (%)
Green – 85	49.0	44.0	78.0	13.0
85 – 58	53.0	47.0	75.0	11.5
58 – 35	56.0	48.0	64.0	10.0
35 – 28	58.0	49.0	51.0	9.0
28 – 19	62.0	48.0	43.0	6.5
19 – 12	60.0	43.0	40.0	5.5
Equalisation – 48 hrs	60.0	55.0	55.0	8.0

## Moisture content

**Sample boards** placed in the stack can be used to monitor the decrease in moisture, at all moisture contents, so it is the preferred method. Moisture content can be measured with **resistance-type meters** only at levels below 25% moisture content; they are inaccurate above this level.

1. Monitor moisture content (MC) using sample boards.
2. If sample boards haven't been used, monitor MC with a resistance meter, applying temperature and moisture correction factors. MC above 25% will be unreadable, but resistance meters can be used to monitor the final drying stages and determining the important end-point.
3. Equalise the stack of boards

## 1. Monitoring moisture content (MC) using sample boards

This method uses the sample boards, small MC sample sections and the oven-dry method to determine MC.

- Determine the moisture content (MC) of the small sample sections A & B using the oven-dry method and equation (1). Calculate the average of the two samples.
- Determine the MC of the sample board during kiln drying by calculating the oven-dry weight using equation (2).
- Determine the sample board MC every day during drying (Monday to Friday). First record the time and date, kiln set-point temperature and humidity values and the kiln actual temperature and humidity values. Weigh the sample boards and use equation (3) to calculate MC.
- If the average MC of the sample boards is less than the next kiln schedule set-point (see the MC content change points given in the drying schedule), then change the kiln temperature and humidity to the settings for the next phase recommended in the drying schedule.

$$\text{Moisture content (\%)} = \frac{\text{Original weight (g)} - \text{Ovendry weight (g)}}{\text{Ovendry weight (g)}} \times 100 \quad (1)$$

$$\text{Ovendry weight of sample board (g)} = \frac{\text{Original weight of sample board (g)}}{1 + \text{average MC of small samples (\%)}} \times 100 \quad (2)$$

$$\text{MC sample board (\%)} = \frac{\text{Current weight of sample board (g)} - \text{Calculated OD weight of sample board (g)}}{\text{Calculated OD weight of sample board (g)}} \times 100 \quad (3)$$

Abbreviations: MC: Moisture content | OD: Oven-dry | g: grams

## 2. Monitoring MC with a resistance meter

Moisture resistance meters are usually calibrated to Douglas fir (*Pseudotsuga menziesii*) so correction factors are needed for other timbers. The correction factors for cocowood are provided in Table ii). A temperature correction is applied (Table i) before moisture correction to estimate the correct MC.

### Moisture correction

- Estimate the board temperature based on kiln conditions.
- Correct for temperature, for example using Table i): if the kiln (board) temperature is 60°C and the moisture meter reads 20%, the new moisture reading is 14%.

i). Temperature correction (for resistance moisture meter)																		
Meter reading %	8	9	10	11	12	13	14	15	16	17	18	19	20	21	22	23	24	25
Wood temp°C	Moisture reading corrected for temperature																	
25	7	8	9	10	11	12	13	14	15	16	17	18	19	20	21	22	-	-
30	7	8	9	10	11	12	12	13	14	15	16	17	18	19	20	21	22	-
35	6	7	8	9	10	11	12	13	14	15	15	16	17	18	19	20	21	22
40	-	6	7	8	9	10	11	12	13	14	15	16	16	17	18	19	20	21
50	-	-	6	7	8	9	10	11	11	12	13	14	15	16	16	17	18	19
60	-	-	-	6	7	8	8	9	10	11	12	13	14	14	15	16	17	18

Source: AS/NZS 1080.1:1997. Timber methods of test

c. Use this moisture reading correction factor in Table ii). to obtain the correct MC of 10%.

ii). Moisture correction factors for kiln drying cocowood (for resistance meters calibrated to <i>Pseudotsuga menziesii</i> )																		
Moisture meter reading (% moisture)																		
6	7	8	9	10	11	12	13	14	15	16	17	18	19	20	21	22	23	24
Corrected moisture content (% moisture)																		
—	—	—	—	8	8	9	9	10	11	11	12	12	13	13	13	14	14	15

Source: Alston, 1982. *Timbers of Fiji. Properties and potential uses.* Department of Forestry, Suva.

### 3. Equalise the stack of boards

When the target MC is reached, the boards must be ‘equalised’ in the stack. This will reduce the variation in the final MC; MC gradients within boards and the residual drying stress.

#### To equalise the boards:

Hold the kiln at the final kiln schedule dry bulb temperature for 1–2 days and adjust the kiln humidity to provide an equilibrium moisture content (EMC) equivalent to the target, final MC.



Stack ready for drying in a solar kiln. Weights still to be added.



## Drying method 2: Pre-air drying + final kiln dry

### Pre-air drying may be relevant:

- when waiting for available kiln space
- during short-term storage and transport from primary processing site to a kiln

### Air-drying is only suitable for export market when:

- the recommended drying stack is constructed
- it is followed by final kiln drying
- sample boards are used to monitor moisture content using the oven-dry method

#### Steps

1. **Build** the stack with rack sticks, sample boards and weights.
2. **Position** the stack where conditions are suitable or can be moderated to optimise drying.
3. **Pre-air dry** the stack of boards (8–11 weeks to reach 17–20% MC)
4. **Monitor moisture content** using sample boards where there is access to:
  - a. an oven heating to 103°C+/- 2°C
  - b. a balance (e.g. top-pan balance)
5. **Kiln dry** to achieve target moisture content for export flooring products.
  - a. use the **kiln drying schedule** to optimise drying conditions (6–7 days)
  - b. **monitor moisture content** using sample boards (for the full MC range) or moisture resistance meters and appropriate correction factors (where sample boards are not used because a suitable oven is not available). Note: resistance meters are only accurate for MC < 25%).
  - c. **equalise** the MC between boards.

Follow the details given in the section on kiln drying.

## Drying method 3: Air drying

Air drying alone is not suitable for export flooring markets because target moisture content of 9–12% cannot be achieved by air drying in humid, tropical or sub-tropical conditions. Also, if the flooring is for domestic markets in airconditioned environments, it is also necessary to lower the final MC by kiln drying.

Air drying is achieved by placing stacks of racked (stripped) cocowood (see the section on stacking cocowood) in natural conditions so that they dry as evenly as possible. Stack the boards using rack strips to space and restrain them in a form suitable for drying. The aim is to achieve a suitable moisture content with minimal degrade.

### Steps

- 1. Position** the stack where conditions are suitable or can be moderated to optimise drying. Natural conditions experienced by the stacks can be moderated by changing their position and orientation in the open, or their position in buildings or shelters. Protect stacks from adverse drying conditions by positioning them in the yard or drying buildings using the site drying schedule as a guide.
- 2. Build the stack** incorporating:
  - a. rack strips** to space and aerate the boards
  - b. sample boards** where an oven and balance are available for monitoring MC **weights** to minimise distortion during drying.
- 3. Protect** the stack or moderate conditions as necessary:
  - a.** use fabric or other shades and screens on the drying building to reduce air flow
  - b.** place stack ‘tops’ (pallet material or iron sheeting) on the top to minimise weathering in the top layers of stacks that are air drying outdoors.
- 4. Monitor moisture content** by either:
  - a.** using sample boards and the oven-dry method where there is access to an oven heating to 103°C± 2°C and a balance (e.g. top-pan balance)\*
  - b.** using resistance meters weekly until 25% MC is reached, then twice-weekly until the target MC is reached
  - c.** a final MC of 17–20% can be expected after 8–11 weeks.

**\*Where oven and balance are not available:** Use a resistance moisture meter to determine when air drying is complete. Because resistance meters are inaccurate above 25% MC, take weekly measurements on four boards per stack to work out when the average MC is below 25%. Then test MC with the meter twice a week to determine when the boards have reached the target MC.

**Note: This method is not suitable for the export flooring market.** Air drying without using the oven-dry method for assessing moisture content may be suitable for domestic markets.

## Grading dry cocowood boards

Only high density boards (>700 kg/m<sup>3</sup> air dry density) are suitable for flooring products in the international market.

Cocowood boards must be graded visually, by personnel trained to assess hardness/density by using vascular bundle patterns. In summary:

### Steps

1. Understand the visual grading parameters for cocowood: straightness, bundle pattern, density homogeneity / evenness and straight boards.
2. Become skilled in recognising the relationship between cocowood density, bundle patterns and position in the stem. Graders must be experienced in this.
3. Create a cocowood density grading tool and train graders in visual grading parameters.
4. Grade cocowood boards using the density grading tool:
  - a. density—differentiate between dissimilar bundle patterns and associate with cocowood density
  - b. homogeneity—assess density homogeneity in boards
  - c. grade and sort boards for appropriate flooring markets.

## 1. Visual grading parameters

- **Straightness** indicates minimal spring, twist or bow.
- **Density** indicates hardness and is graded using vascular bundle patterns (surface area of vascular bundles relative to ground tissue, see below) in the end-grain.

Homogeneity: Boards that have a relatively homogenous density (15% variation or less) and straight grain (variation less than 8°) are suitable for high value flooring products.

The buyer decides on the allowable proportion of lower density material in each board. The buyer and manufacturer may have different thresholds, and these need to be negotiated before the wood is graded.

Industry generally tolerates a 10% allowance for subjective variation in visually-graded product. To allow for this, the industry benchmark is to add 10% to the order.

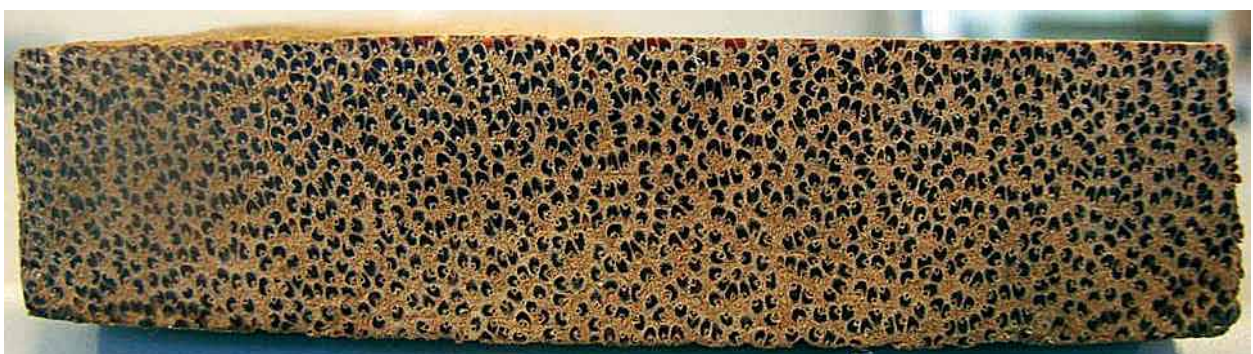

End section of a high density cocowood board, showing the high relative surface area of vascular bundles.

## 2. Relationship between cocowood density, bundle patterns and stem position

Visual grading is determined by the **vascular bundle patterns** in the end-sections of cocowood boards, so it is important to ‘read’ these patterns correctly.

### Some definitions

Cocowood density is correlated with the **‘bundle pattern’**.

Bundle pattern = *surface area of vascular bundles relative to ground tissue*

= *size + concentration (number of bundles per unit surface area)*

Bundle pattern	High density cocowood -typical patterns	Medium / low density cocowood- typical patterns
size + concentration (number of bundles per unit area)	<ul style="list-style-type: none"> <li>• Large, darker bundles &amp; medium concentrations</li> <li>• Smaller bundles in high concentrations</li> </ul>	<ul style="list-style-type: none"> <li>• Large bundles in low concentrations</li> <li>• Smaller bundles in low to medium concentrations</li> </ul>

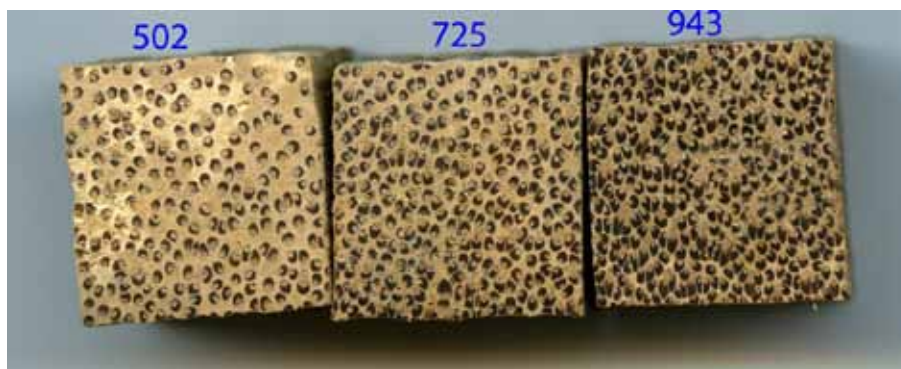

Bundle patterns for cocowood sections with three different densities: 502 kg/m<sup>3</sup>, 725 kg/m<sup>3</sup> and 943 kg/m<sup>3</sup>. Cocowood sections are 18 x 18 mm and dried to 12% moisture content.

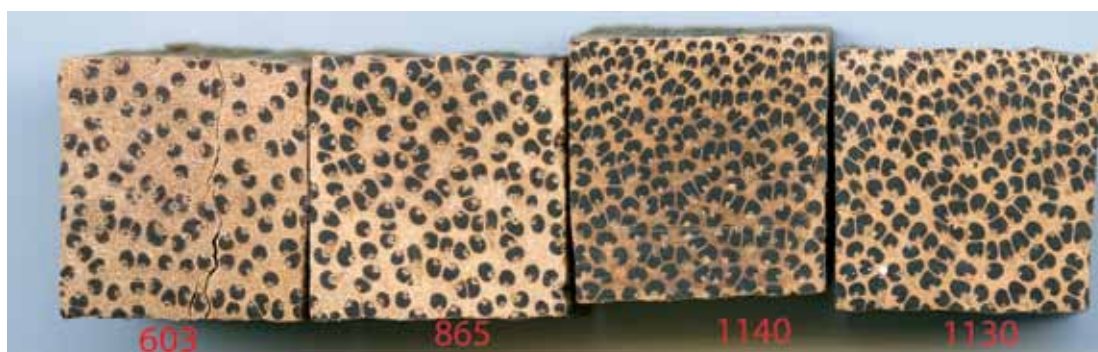

Bundle patterns for cocowood sections with four different densities: 603 kg/m<sup>3</sup>, 865 kg/m<sup>3</sup>, 1130 kg/m<sup>3</sup> and 1140 kg/m<sup>3</sup>. Cocowood sections are 18 x 18 mm and dried to 12% moisture content.



ACTUAL SIZE  
(18m x 18mm)

This figure shows bundle patterns and density for sections of cocowood in relation to their position in the palm stem.

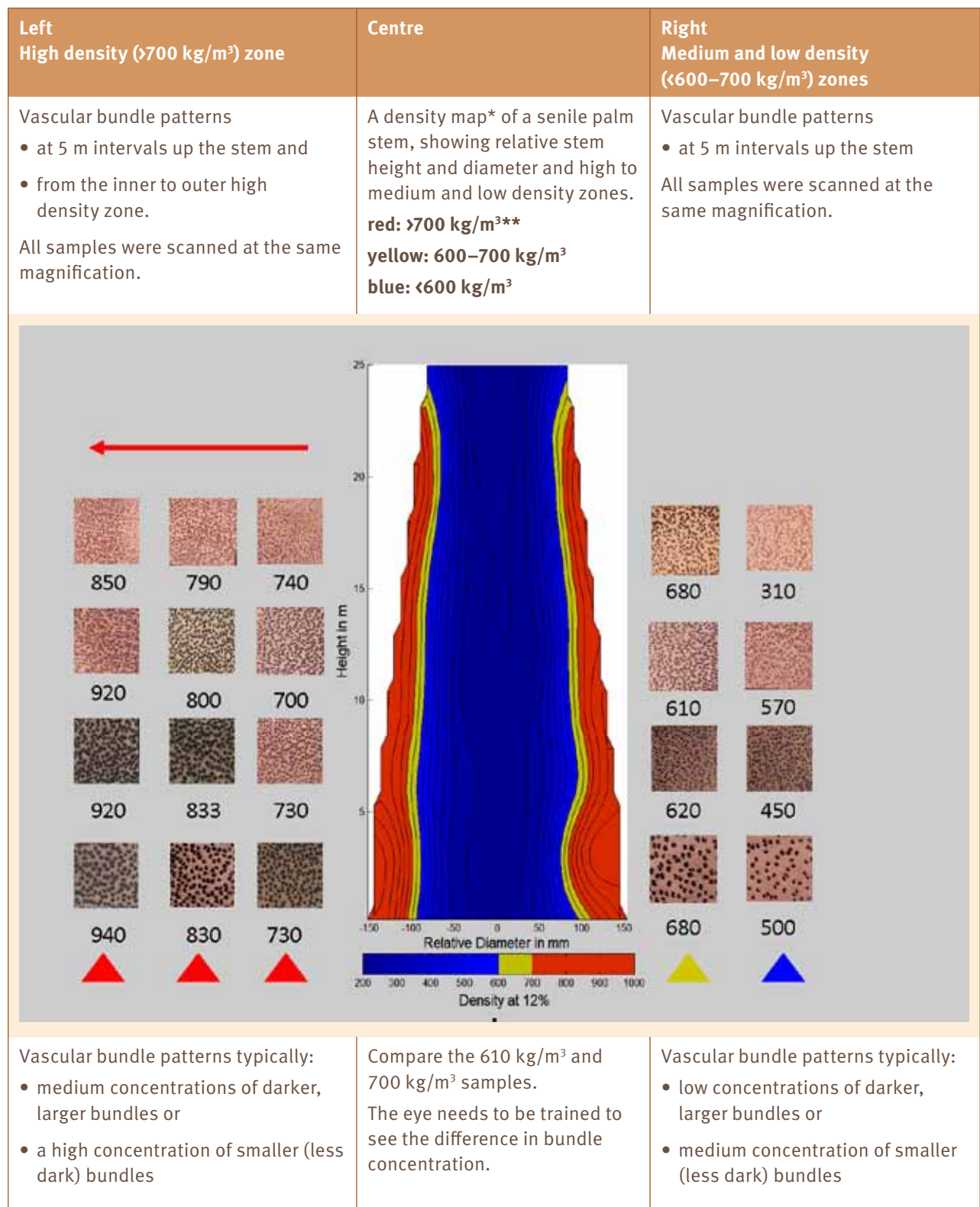

Bundle patterns and densities of cocowood sections displayed according to their position in a single palm stem, which is represented by a map of fibre density distribution.

\*The map was created from 140 cocowood samples with known density and position in a 100 year old palm.

\*\*Air dried density (kg/m<sup>3</sup>) was measured for each sample.

### 3. Create a cocowood grading tool

This is a visual cue to help the grader associate vascular bundle patterns with cocowood density and hardness. It is a table of photographs showing the relationship between bundle patterns and position in the palm stem.

Graders need to become skilled in recognising the variation in bundle patterns related to density. This requires training to differentiate between patterns in vascular bundles in cocowood cross-sections. Creating a series of these cocowood grading tools is part of the training.

- Cut discs at 5 m intervals from a **mature** palm stem at: 1 m, 4 m, 7 m, 10 m and 13 m. Older palms have the full range of density zones.
- De-bark the discs.
- Cut 5 samples (each 20 x 20 mm), starting at the outside edge, progressing radially, towards the centre.
- Dry and weigh each sample and calculate air dry density for each one.
- Glue the samples (end-face up to show bundle patterns) on a board, arranged relative to the position of the parent discs in the stem. This arrangement will capture the change from harder (outside material) to less hard (transitional) and softer material (inner core).
- Identify (and mark) the relevant grading threshold for high density on this tool.

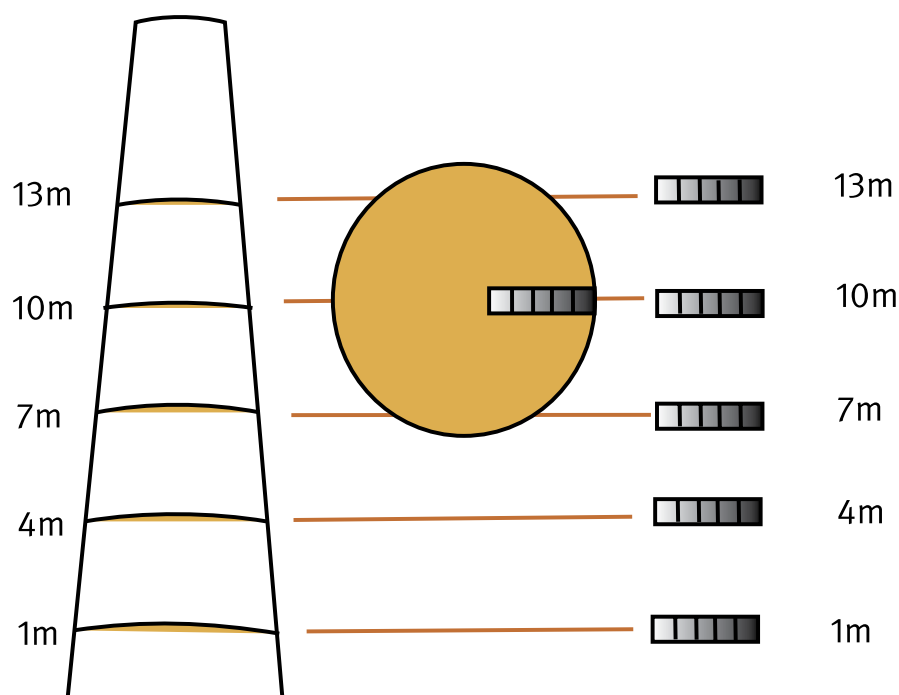

cut 5 discs from palm stem & debark

cut 5 samples (each 20 x 20 mm) starting from the outer edge, towards the centre

arrange samples as a chart- to correspond with height and position in the disc

## 4. Grade boards using the cocowood density grading tool

- Grade each board using the density grading tool. Differentiate between dissimilar bundle patterns and associate with cocowood density.
- Assess the evenness of density (homogeneity) throughout each board.
- Sort boards for appropriate flooring markets.

## Product specification for export markets

### Flooring specifications – all products

These specifications meet the international standards for solid or engineered flooring products.

General	European market	Australian market
Density (air dry):	700 kg/m <sup>3</sup> or greater	700 kg/m <sup>3</sup> or greater
Discolouration: stain or spots	None	
Distortion: bow, twist, cup	As for EN 13226:2009 Wood Flooring - Solid Parquet Elements with Grooves and/or Tongues.  as for EN 13696:2009 Wood Flooring - Test Methods to Determine Elasticity and Resistance to Wear and Impact Resistance	As for AS 2796.1–1999. Australian Standard. Timber—Hardwood—Sawn and milled products. Part 1: Product specification
Moisture content:	All solid wood flooring, 9% (+/- 2%) Parquetry: 9% (+/- 2%) Tongue and groove: 9–12%	Engineered overlay: 9–14% (target 9%) Parquetry: 8–13% (target 9%) Tongue and groove: 9–14% (target 9%)
Colour	High density only: mix lighter and darker shades through the pack	

Product dimensions	European market	Australian market
Engineered overlay flooring	Manufacture a 15 mm overlay board from a laminated beam constructed from 8, 20 mm thick boards that are glued to 12 mm plywood.	Manufacture a 15 mm overlay board from a laminated beam constructed from 8, 20 mm thick boards that are glued to 12 mm plywood.
Tongue and groove	As for EN 13226:2009 Wood Flooring - Solid Parquet Elements with Grooves and/or Tongues: common dimensions - 15 x 90 x 450/990 mm 15 x 100 x 500/800/1000/12000/ 1500/2000 mm	As for AS 2796.1–1999. Australian Standard. Timber—Hardwood—Sawn and milled products. Part 1: Product specification
Parquetry	As for EN 13226:2009 Wood Flooring - Solid Parquet Elements with Grooves and/or Tongues: common dimensions - Piece: 16 x 22 x 160 mm, surfaced 2 sides Bundle: 2x (16 pieces),	As for AS 2796.1–1999. Australian Standard. Timber—Hardwood—Sawn and milled products. Part 1: Product specification



## Australian market

### 1. Engineered overlay flooring

**Density.** All export grade flooring products are made from cocowood boards with an air dry density of 700 kg/m<sup>3</sup> or greater.

**Moisture content.** The moisture content range is 9–14%; target 9%

**Colour.** If the density requirements are met, boards should be randomised to mix lighter and darker shades throughout the pack.

#### Recommended manufacture of a 15 mm overlay flooring product

The trend in timber flooring products is for wide boards, especially 133 mm or 5¼ inch but wide cocowood cover widths are difficult to produce because:

- wide boards are liable to shrink and expand in service in response to changing environmental conditions
- high variability in density and grain alignment over a small cross-section can worsen distortion

**The engineered overlay** is a wide board surface layer is produced by re-sawing a laminated beam constructed from 20 mm thick boards.

**Construct the beam** from 8 dressed boards of high density cocowood, which are bonded and clamped using the adhesive manufacturers' recommendation. This is shown in the diagram.

**Cure** the beam.

**Saw the cured beam** with a multi-rip sawmill or re-saw bandsaw to produce the surface lamellae.

**Bond the lamellae** to a 12 mm panel substrate, such as plywood.

**Re-saw** to the desired width and

**Run through a moulder** to produce the tongue and groove profile with bevelled edges on the bottom.

**Sand** the top surface.

**Coat** with the required finish.

#### All other specifications

Follow the specifications for overlay flooring set by AS 2796.1–1999. Australian Standard. Timber—Hardwood—Sawn and milled products. Part 1: Product specification.

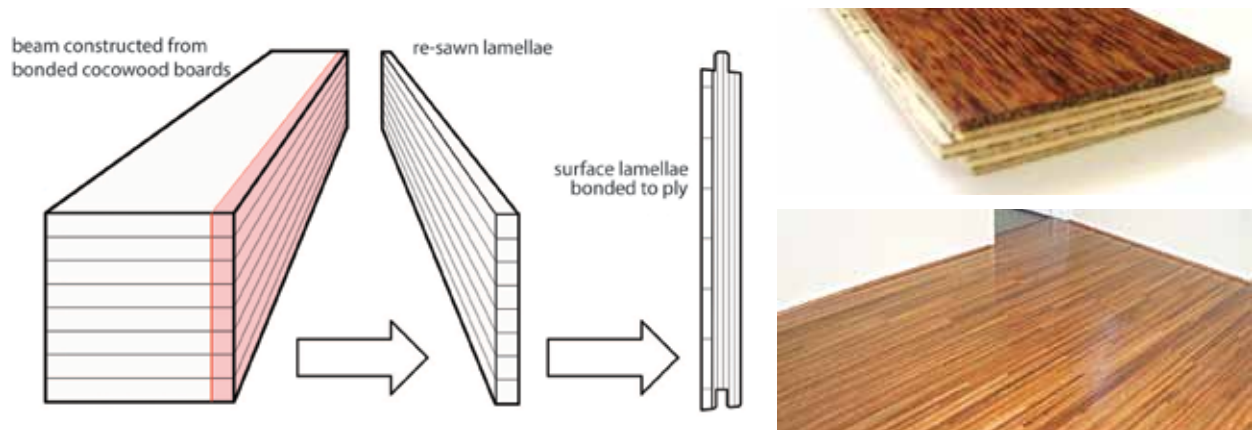

Constructing the wide boards from bonded lamellae.

Engineered overlay board (above) and in service.

## 2. Tongue and groove (T&G)

**Density.** All export grade flooring products are made from cocowood boards with an air dry density of 700 kg/m<sup>3</sup> or greater.

**Moisture content.** Required moisture content: 9–14%.

**Colour.** If the density requirements are met, boards should be randomised to mix lighter and darker shades throughout the pack.

### All other specifications.

Follow specifications set by AS 2796.1–1999. Australian Standard. Timber—Hardwood—Sawn and milled products. Part 1: Product specification.

## 3. Parquetry

**Density** All export grade flooring products are made from cocowood boards with an air dry density of 700 kg/m<sup>3</sup> or greater.

**Moisture content.** Required moisture content: 8–13% (target 9%)

**Colour.** If the density requirements are met, boards should be randomised to mix lighter and darker shades throughout the pack.

### All other specifications

Follow specifications set by AS 2796.1–1999. Australian Standard. Timber—Hardwood—Sawn and milled products. Part 1: Product specification.

## European market

### 1. Tongue and groove (T&G) (some common characteristics)

Always check specifications with the buyer.

**Density.** All export grade flooring products are made from cocowood boards with an air dry density of 700 kg/m<sup>3</sup> or greater.

**Moisture content.** Required moisture content: 9–12%.

**Colour.** If the density requirements are met, boards should be randomised to mix lighter and darker shades throughout the pack.

### Cutting profile:

Thickness - total: 15 mm

Width: 90 mm, or 100 mm

Lengths for 90 mm width flooring: 450 / 990 mm

Lengths for 100 mm width flooring: 500 / 800 / 1000 / 1200 / 2000 mm

### Cover surface

- thickness of **upper** surface: 6 mm
- thickness of **lower** surface: 4 mm, with four bevelled edges all round approximately 2 mm
- total finished width of 90 mm **lower** surface = 89 mm
- total finished width of 100 mm **lower** surface = 99 mm.

### **Tongue**

- thickness: 5 mm, with micro-bevelled edges at 4, 5 mm
- width: 6 mm.

### **Groove**

- thickness: 5 mm
- width / depth : 7 mm
- 1 mm remaining when tongue is inserted into the groove.

### **Lower surface:**

- 3 small grooves to facilitate gluing.



Tongue and groove construction, 90 mm cocowood boards. Images courtesy of *PlanetCoconut*

### **All other specifications**

Follow the relevant European standards e.g. EN 13226:2009 Wood Flooring - Solid Parquet Elements with Grooves and/or Tongues.

## ***2. Parquetry***

Always check specifications with the buyer.

Cut parquetry dimensions per piece: 16 x 22 160 mm, surfaced two sides (S2S)



Parquetry pack (left) and in-service. Images courtesy of PlanetCoconut

Follow the relevant European standards, e.g. EN 13226:2009 Wood Flooring - Solid Parquet Elements with Grooves and/or Tongues.

## ***3. Engineered overlay flooring***

See specifications for the Australian market.

# Machining and sanding

## Machining

- **Tungsten-carbide** tool edges provide the best results at feed-speeds of 12 metres per minute (m/min).
- Tools made from **cobalt-base alloys** strengthened with tungsten and molybdenum (known as stellite alloys) give a better quality result at higher speeds, such as 24 m/min.
- **For mouldings**, lower feed speeds are recommended to reduce the risk of torn grain and soft tissue roughness, which are more likely at higher feed-speeds.
- **When profiling**, for example when producing a tongue and grooved profile, lower feed speeds are recommended. Tear-out occurs where bundles meet the surface at an angle rather than align parallel to the surface.
- If the material is **prone to grain or soft tissue roughness**, use lower feed speeds.
- **Cross-cutting** negative cutting angle blades and positive cutting angle blades also provide good results.
- **Rip sawing** straight blades provided a better result than bevelled blades, where the board is cut longitudinally. Straight blades produce fewer splinters and tear-out.

## Sanding

Cocowood can be sanded to a smooth finish at a range of speeds, although better results are achieved at a speed of 12 m/min than at 18 m/min.

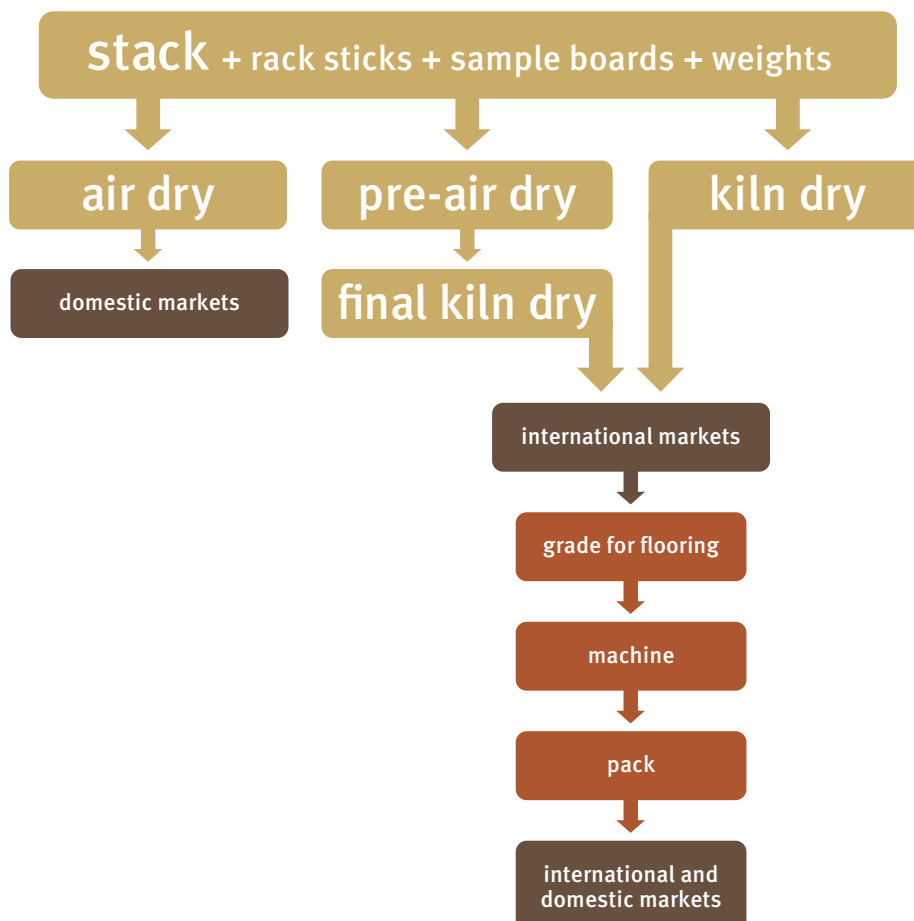

## Storing and packing dried boards

During storage and transport always actively protect cocowood boards from unacceptable variation in moisture content.

- Maintain the cocowood in optimal conditions while it is stored.
- Ensure that the moisture content is appropriate when it is received or dispatched.
- Protect the boards during storage and transport by wrapping individual packs in plastic.

Dried and milled cocowood in store represents a significant cost of production and potential income, so it is important to maintain the quality for selling to the target market.

### *Dried boards risk changes in moisture content*

The moisture content after final drying is liable to change with ambient conditions. If changes in moisture content are likely to reduce potential income or the cocowood becomes unsuitable for the intended market, the conditions need to be controlled and the cocowood protected.

Generally:

- the harsher the local climate (tropical conditions), the more exacting the market (European, North America and Australia)
- the greater the loss in potential value, the higher the level of control and protection is warranted.

### *Protecting the boards*

Wrapping individual stacks in plastic is the most cost effective and easiest method of controlling moisture adsorption or desorption during storage and transport. Remove the strippers from the dried stack, and wrap as an individual block or pack.

Plastic-wrapping each pack individually provides short-term protection from external conditions. The length of time protection lasts depends on the permeability of the material and the integrity of the wrapping.

Dried packs should be wrapped on all six sides using a high grade (gardening) plastic. If lower grade plastic is used then 2–4 layers may be needed. Always seal the ends of the plastic with tape, leaving minimal gaps for water movement. Moisture can enter through any unwrapped surface. Also, some plastics break down relatively quickly, holding any incoming moisture close to the cocowood. Replace any torn or punctured wrapping.

Dry material stored unwrapped in the open degrades very quickly.

Enclosed, environmental control chambers are an effective alternative, where available.

## 3. Resources

### Contacts

Cocowood project [www.cocowood.net](http://www.cocowood.net)

Australian Centre for International Agricultural Research (ACIAR) [www.aciar.gov.au](http://www.aciar.gov.au)

Department of Employment, Economic Development and Innovation (DEEDI)  
Business Information Centre 13 25 23  
[www.deedi.qld.gov.au](http://www.deedi.qld.gov.au)

### More information

Cocowood. Properties and processing facts for coconut ‘wood’. Department of Employment, Economic Development and Innovation (DEEDI). PDF available at [www.cocowood.net](http://www.cocowood.net)

Alston, AS (1982) Timbers of Fiji, properties and potential uses. Department of Forestry, Suva, Fiji.

Arancon, RNJ (1997) Asia-Pacific Forestry: Focus on Coconut Wood. Paper No. APFSOS/WP/23. FAO, United Nations, Rome.

Arancon, RNJ (2009) Asia-Pacific Forestry Sector Outlook Study II: The situation and prospects for the utilization of coconut wood in Asia and the Pacific. Working Paper series No. APFSOS II/WP/2009/15. Food and Agriculture Organisation of the United Nations, Rome.

AS 2796.1—1999. Australian Standard. Timber—Hardwood—Sawn and milled products. Part 1: Product specification\* [www.saiglobal.com](http://www.saiglobal.com)

EN 13226:2009 Wood Flooring - Solid Parquet Elements with Grooves and/or Tongues. Standard distributed by British Standards International: BSI.<http://shop.bsigroup.com>

EN 13696:2009 Wood Flooring - Test Methods to Determine Elasticity and Resistance to Wear and Impact Resistance. Standard distributed by British Standards International: BSI.  
<http://shop.bsigroup.com>

Gibe, ZC (1985) The Philippines’ recommendations for coconut timber utilisation. Philippine Coconut Authority. Council for Agriculture and Resources Research and Development (PCARRD), Philippines.

Keating, W & Bolza, E (1982) Characteristics, properties and uses of timbers. South-east Asia, Northern Australia and the Pacific. Inkata Press.

Killmann, W. and Fink, D. (1996) *Coconut palm stem processing*. A technical handbook. Department of Furniture and Wooden Products, GTZ, Eschborn, Germany, 204 pp.

Poulter, R & Hopewell, G (2010) Secondary cocowood products. Potting mix. (DEEDI), Brisbane, Australia.

