

VOL. 72. PART 3

MARCH, 1951

DEPARTMENT OF AGRICULTURE



QUEENSLAND AGRICULTURAL JOURNAL



*Preparing for a Dry Spell. Harvesting
Ensilage in the Boonah District.*

LEADING FEATURES

Gully Erosion
Banana Growing

Producing Choice Cream
Sheep Blowfly Problem

Agriculture in the Callide and Dawson

Volume 72

Part 3

QUEENSLAND AGRICULTURAL JOURNAL

Edited by
C. W. WINDERS, B.Sc.Agr.



MARCH, 1951

Issued by Direction of
THE HONOURABLE H. H. COLLINS
MINISTER FOR AGRICULTURE AND STOCK

GOVERNMENT PRINTER. BRISBANE



Contents



	Page.
Soil Conservation—	
Soil Conservation in Queensland—	
7. Prevention and Control of Gully Erosion	125
Field Crops—	
Agriculture in the Callide and Dawson Valleys	138
Fruit Culture—	
Banana Growing in Queensland	147
Weed Control—	
Control of Eucalypt Seedlings and Suckers	159
Precautions in Using Dinitro Weedkillers	161
Dairy Farming—	
How to Produce Choice Cream	163
Sheep and Wool—	
Sheep Blowfly Problem in Queensland	169
Cattle Husbandry—	
Beef Cattle Production on Some of the Gulf Watersheds ..	176
Astronomical Data for April	185

STATE'S SEEDS

ALL GRADED AND GOVERNMENT TESTED



*Prices, information, etc., will
be forwarded on application*

SEED OAT SPECIALTIES

CLOVERS—Subterranean Cert.
 CLOVERS—Red
 PEAS—Greenfeast
 PEAS—Grey Field
 PEAS—Poona
 BEANS—Brown Beauty
 RAPE—Dwarf Essex and Giant
 LUCERNE SEED—Hunter River



STATE PRODUCE AGENCY

PTY. LTD.

ROMA STREET BRISBANE



Soil Conservation in Queensland.

7. The Prevention and Control of Gully Erosion.

J. E. LADEWIG, Senior Soil Conservationist, and A. F. SKINNER, Soil Conservationist.

GULLY erosion is an advanced symptom of the misuse of land and is usually due to the concentration of the resultant excessive and uncontrolled runoff in either natural or artificial drainage depressions from which protective vegetation has been either partly or wholly removed (Plate 79).



Plate 79.

This Gullied Area was a Stable, Well-vegetated Drainage Line Thirty Years Ago.

This form of erosion normally develops either on or below land on which increased runoff has been induced by such factors as systems of square farming on sloping land, burning of pastures and crop residues and excessive grazing. The destruction of protective vegetation (including the dead ground litter therefrom) by such means immediately alters Nature's former complex relationship between soil, plant cover, and rainfall. Increased runoff and wastage of soil and water follow quickly upon the removal of this surface filter bed which formerly ensured the unimpeded entry of clean water into the soil. Following the removal of the surface cover, water, which can no longer infiltrate into the soil as quickly as it falls, is free to run off at high velocity because of the absence of plant material to hinder and obstruct its downward course. If the resultant increased runoff is permitted or assisted to concentrate in unsuitable drainage ways the formation of gullies is a normal sequence.

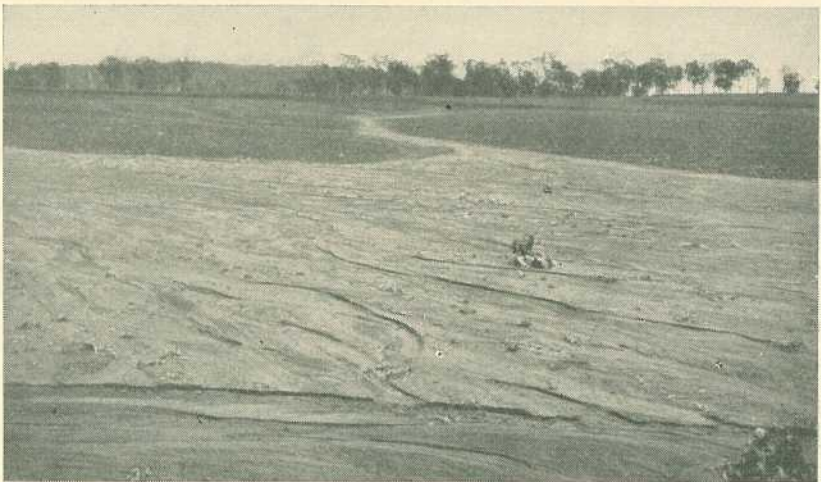

Plate 80.

An Area Showing Evidence of Serious Sheet Erosion. Gullying Will Follow Rapidly.

The ploughing of grassed depressions as part of the cultivated fields, the formation of cattle tracks along water carrying depressions, the construction of certain types of farm drains and the collection of water in roadside channels are examples of common practices which lead to the formation of gullies.

Insidious sheet erosion, which on cultivated land normally precedes gully erosion (Plate 80), frequently develops to an advanced degree without attracting attention.

Gully erosion, although often directly damaging less land than sheet erosion, is more spectacular and menacing in appearance and therefore generally tends to provoke immediate alarm. Gullies, once started, will continue to develop and form branches until the factors which contributed to their formation are eliminated. If not controlled, gullies can ultimately render useless for further crop production comparatively large areas of land.

They cause considerable inconvenience to landowners through interference with farming operations, and as they develop and multiply they progressively increase the cost of such work. Further inconvenience is caused by the dislocation of access routes.

A network of deep gullies can adversely affect the yield of crops grown on adjacent land by lowering the soil water table. Not infrequently, serious gullies develop down the headlands of cultivated fields due to the effect of ploughing operations. Usually such gullies undermine and destroy fence lines (Plate 81).



Plate 81.

A Fence Line Undermined by Gully Erosion.

The sub-surface soil and subsoil disgorged from gullies frequently contributes towards the choking of life-giving watercourses with useless debris. Such material is sometimes deposited as infertile and sterile overburden on lower valuable crop land or pasture.

The formation of gullies along arterial and lateral drainage lines is particularly serious and adds considerably to the difficulty of designing safe farm drainage schemes. Originally most of these drainage lines existed in the form of stable and well vegetated depressions; the development of gullies in very many instances has unfortunately resulted from the failure of landowners and others to recognise the importance of preserving them in this condition. The present mutilated condition of many such depressions is directly attributable to the fact that they have been ploughed up for crops or have been abused by stock (Plate 82).

Gullying often occurs in cultivated fields with comparatively small catchment areas. Such cases represent the final stage in the usual farm land erosion cycle and differ from gully erosion in main drainage lines. Following the initial cultivation of sloping arable lands, the first stage in the erosion cycle is the development of insidious sheet erosion in which thin sheets of soil are lost but the topography of the land remains comparatively unaltered. In the next stage, runoff tends to concentrate in depressions which may have been created by certain cultivation practices or methods of ploughing, or which may be natural hollows that were existent prior to settlement. With each succeeding rain these depressions become more defined. More and more water tends to concentrate in them and velocity of flow usually increases

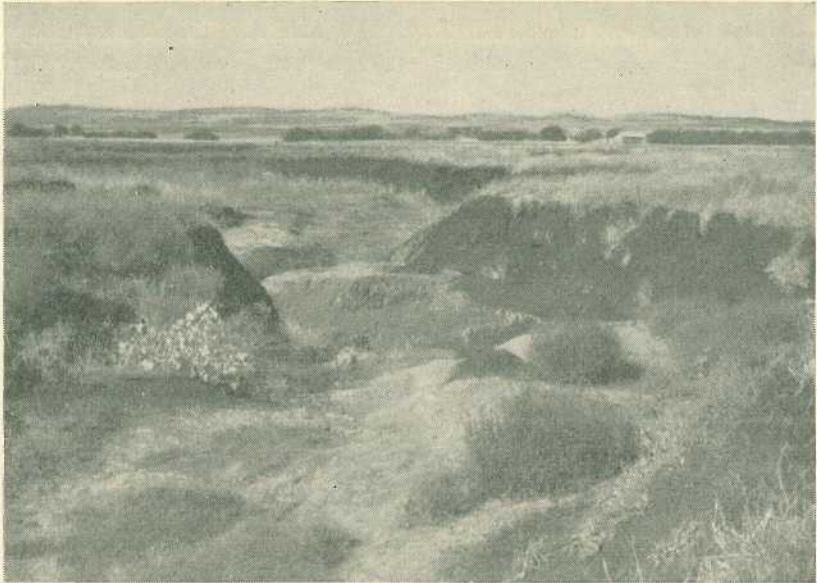

Plate 82.

An Unstable Drainage Line on the Darling Downs.

greatly as a result. Over a period of years these depressions increase in depth through erosive action and so a gully commences; as the depth of the gully increases the sides and head become steep and unstable and thus become increasingly unfavourable for the growth of vegetation.

During the early stages of gully formation, water tends to wash out numerous potholes in the bottom. These then deflect water laterally and ultimately result in the meandering or snake-like course of gullies. Usually from one of the original potholes an active gully head develops which provides inflowing water with a vertical drop (Plate 83).

The energy of the falling water is usually sufficient to undermine the base of the overfall; the overhanging ledge soon breaks off and falls and the process then repeats itself. In this way gullies always eat their way uphill along the centre of the drainage line feeding them. Secondary



Plate 83.

Water Dropping Over the Head of This Active Gully Causes it to Cut Back Along the Drainage Line.

depressions are eventually intercepted by main gullies and from these lateral or branch gullies develop.

For this reason no contour bank or farm drain of any type should ever be discharged into a gully (Plate 84).



Plate 84.

Gullying Occurring Along a Contour Bank Where it Has Been Turned into a Deep Gully.

TYPES OF GULLIES.

Gullies may be broadly classified into two main groups:—

- (1) *Those occurring mainly on cultivation land and where the drainage area rarely exceeds 50 acres* (Plate 85). These gullies are rarely more than 3 feet deep but may occur at intervals of 200 feet or less across the slope. They represent a very substantial soil loss and in addition cause considerable inconvenience in cultural operations; because of this many of these gullies are ploughed in so that they can be crossed with implements. This practice should not be adopted without the associated construction of contour banks because of the danger of further soil loss in subsequent rains.



Plate 85.

Gully Erosion Occurring in a Cultivation Field With a Comparatively Small Catchment.

- (2) *Drainage Line Gullies*: This type of gully occurs mainly in natural depressions which have become unstable due to the loss of protective plant cover. Once gullying commences it rapidly expands in depth and length. Because of the large quantities of soil carried away it is inevitable that deposition of silt will occur as the gradient decreases; ultimately this results in an alternation of overfalls and silt fans throughout the length of the drainage line. Each overfall continues to progress up to the next silt fan which ultimately again becomes an overfall and so the erosion cycle continues. The resultant effect is an accelerated loss of soil in the upper sections of the waterway, sedimentation in lower streams and flooding of level lands where the channel capacity is reduced because of the development of silt fans.

The shape and size of gullies is governed largely by the characteristics of the subsoil. With unabsorptive types of clay subsoil, shallow and wide gullies usually form, while with deep and friable subsoils vertical walled U-shaped gullies develop. The slope and the

size of catchment area draining into the gully are other influencing factors. As moving water tends to reduce the floor of gullies to a level longitudinal gradient, it is a general rule that depth of cut progressively increases as the gully eats upwards.

PREVENTION OF GULLY FORMATION.

Since gullying results from the combined effect of excessive catchment runoff and instability of drainage lines, it can be prevented if these contributing factors are reduced or eliminated.

Runoff may be reduced by the application of the various measures described in previous articles of this series; the most important is the adoption of land utilisation practices which will ensure the absorption and pondage of the maximum amount of rain on the site where it falls.

Protection of drainage lines can be assured if care is taken in the initial ploughing of land to ensure that the existent plant cover in depressions is not disturbed. The fencing of drainage lines to prevent access of stock is the most practical method of ensuring the preservation of cover on these waterways.

Where incipient gullying has commenced in arable lands, stability can be achieved by the construction of a series of contour banks which intercept the runoff water and transfer it across the field at low velocities to a stable well-vegetated outlet or waterway. Under these conditions gullies may be filled in with the assurance that the factors causing the original gullies have been eliminated.

It is better to prevent the development of gullies, firstly because the necessary preventive work can be done at a fraction of the alternative and subsequent cost of reclaiming them, and secondly because it ensures retention of soil which would otherwise be lost.

RECLAMATION OF GULLIES.

The cost of reclaiming gullies is often high, but in estimating the value of such work it is important to realise that a gully directly affecting only a few acres of land may ultimately endanger or destroy large areas of land both above and below its original site. It and other similar gullies may also constitute a serious menace to roads, reservoirs, streams and ports because of resultant siltation.

Gully stabilisation can be achieved most successfully and economically by the utilisation of vegetation to the maximum extent. Probably the most effective, but perhaps not the most practical method, is to reshape the gully if necessary and plant the entire gully with suitable vegetation. This may necessitate the temporary diversion of water during the period of treatment. In many cases stabilisation can be obtained in time by simply fencing gullies out and preventing the access of stock; the planting of vigorous species of plants will assist considerably.

The infertile subsoil exposed in gullies usually makes the establishment of vegetation difficult, but provided stock are excluded and fertilizer is applied a satisfactory growth of vegetation can usually be obtained. Because of the danger of large flows removing the vegetation before it is well rooted, it is preferable to temporarily prevent runoff from entering the gully by the construction of diversion or pondage

banks above the gully head. However, where large catchments are involved, it is impracticable to divert the large volumes of runoff and stabilisation must be effected while the gully continues to serve as a water disposal line.

This can only be achieved by the systematic application of measures designed, firstly, for the elimination of the erosive waterfall effect at the gully head, and secondly, for the reduction of the longitudinal gradient of the gully floor in order to lessen the velocity of flow and induce siltation.

Provided the rate of encroachment of the gully is not rapid, control can occasionally be effected by the use of vegetation only, and without the necessity for earthmoving work or the use of special drop structures such as check dams or flumes. The procedure in this case involves the use of strong vegetative barriers at intervals across the bed of the gully to induce siltation and reduce the water velocity. Such plants as elephant grass and cow-cane are suitable for this purpose; canes up to 3 feet long are planted in a semi-vertical position across the gully bed and partly up the sides. Three rows of canes are planted, 18 inches apart, with 18 inches between canes in the row; each series of canes should be about 50 feet apart. Within a few years these grow into a dense barrier of cane which impedes the flow of water, thus reducing the risk of further erosion. Such barriers also result in the deposition of silt and the gradual raising of the bed of the gully. This provides a favourable site for the establishment of other types of vegetation. At the same time as the barriers are established, vigorous vegetation such as Rhodes grass, kikuyu grass and couch grass should be established on the base and sloped sides of the gully and particularly around the head or overfall.

Although slow, this method of stabilisation is inexpensive and is well suited to those gullies which are only moderately active. The whole of the gullied area should be fenced off to exclude stock.

GULLY CONTROL STRUCTURES.

Since the ultimate aim in gully control work is the establishment of a permanent cover of vegetation over the entire gully, many of the control structures need only be of a temporary nature but must be capable of preventing further erosion during the period in which the permanent vegetation is being established.

Gully Head Control.

A primary requirement is the stabilisation of the overfall at the head of the gully and this can be achieved in a number of ways:—

- (1) The overfall is sloped so that there is a batter of at least one in three—that is, a fall of 1 foot for every 3 feet length of the slope. A more gradual batter or slope of 1 in 5 is preferred but in large gullies this may involve excessive earthmoving. After the overfall has been sloped, kikuyu or couch grass is sprig planted at reasonably close intervals and watered. The whole surface is then covered with a mulch layer two to three inches deep and pegged down with wire netting. Provided the work is executed carefully, the mulch will protect the soil surface against damage from

water flow while the grass is becoming established. Care must be taken to make certain that all water passes over the protected zone and not around it, or under it, as it would then create a new overfall.

- (2) In this method the overfall is sloped as in the previous case and grouted stone or rock crates are used as a protective lining. The section intended to carry water is dished to the extent of one to two feet in order to concentrate the flow and reduce the width of the structure required. On clay soils which crack when dry, rigid stone grouted structures are seldom successful. Concrete or metal flumes are also sometimes used to ship water down to lower levels. In all cases it is essential that they be made of adequate capacity and that no water passes around the top of them.

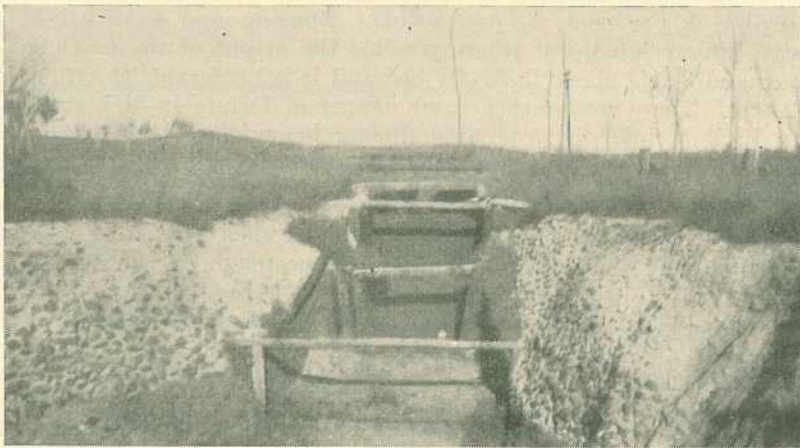

Plate 86.

A Wood and Masonry Structure Used to Stabilise a Deep Gully.

Where rock crates are utilised, quantities of small stone are bound with wire netting into convenient units and the crates are tied to each other with wire.

- (3) Vertical concrete or masonry weirs or check dams are used to stabilise the overfalls without any appreciable alteration in the slope of the face. If these are erected on a solid and well constructed concrete footing they are much more permanent on heavy clay soils than leaning stone grouted structures. It is most essential that adequate provision be made at the base of these structures to protect them against undercutting. It is also essential either that they be provided with wings to funnel all water through them or that their sides be made some feet higher than the crest of the overflow section to ensure that no water passes around them (Plate 86).

Gully Bed Stabilisation.

This is a very necessary requirement, otherwise further erosion along the bed of the gully will ultimately result in the undermining of gully head control structures.

A series of temporary check weirs erected across the bed of the gully are of value in this connection and assist, firstly, by trapping water and silt to aid the establishment of vegetation, and secondly, by reducing the channel gradient of the gully to a series of level steps and weirs. In this manner the velocity of water flow can be controlled and further erosion prevented until such time as permanent protection has been gained with vegetation.

In the design and construction of these weirs the most important factors are the spacing, height and cross-section; it is highly desirable that the weirs be spaced so that the crest of one weir is level with the base of the weir above, but in special circumstances a gradient not exceeding 1 per cent. is permissible. Spacing and weir height are therefore correlated, but where possible the height of the notch should not exceed 3 feet above the gully bed and it is preferable to reduce this to 2 feet. There is a much greater danger of failure in high structures than in low closely spaced ones during heavy flows, and this factor must be considered in conjunction with the estimation of flow when the control plan is being designed.

The cross-section of the weir should be such that it is lowest at the centre, and the depth and width of the notch or overflow section is determined by the anticipated volume of the flow in the gully. The notch should have sufficient capacity to ensure that the water does not flow around the end of the weir and undermine the structure. It is the neglect to provide a notch which is responsible for the failure of many of the gully control structures erected by landowners in the past. It has often been the practice to lay logs across the gully and the top log presents a level surface from one side of the gully to the other. As soon as water starts to overtop the log it immediately commences to cut into the bank at the ends of the log and results in the undermining of the structure.

The provision of an erosion resistant apron at the base of the weir is essential to prevent undercutting at this point. The most successful type of apron consists of a sub-surface concrete basin which when filled with runoff water serves to dissipate the energy of further falling water.

The type of structure to be used will depend upon the catchment area drained by the gully, the soil type and the size and depth of the gully. Included in the structures which may be utilised are earth weirs, stake and netting structures, brush weirs, and concrete or masonry structures. The cost of these varies widely.

Earth Weirs.

This type of structure is formed entirely of soil which is obtained by dozing in the sides of the gully to at least a 1 in 3 batter at the point where the weir is to be located. The sloped gully sides and the

crest of the weir merge into a smooth concave outline with the lowest part of the weir at the centre. The weir should be at least six feet wide at the top and approximately two feet high; the shoulders of the weir taper gradually to the gully bed with a slope of 1 in 4 or more on the lower side. However, unless these weirs are protected they will wash out during the first heavy rains and consequently it is necessary to plant kikuyu, couch or buffalo grass sods over the entire surface of the weir, then cover with straw to a depth of two to three inches, and finally peg down with wire netting.

This method of gully bed stabilisation, though not widely used as yet, offers considerable promise because of the low capital expenditure involved. The sloping of the gully sides is at all times a necessary prerequisite for the establishment of vegetation and the soil thus obtained can be easily formed into weirs in the bed of the gully. These operations can be performed very effectively with simple dozer attachments on ordinary farm tractors. The key to this method of control however, is the necessity for the *immediate* sodding, mulching, and netting of the weirs.

Stake and Netting Structures.

These consist simply of a series of netting fences erected across the gully with appropriate precautions to prevent cutting out at the ends and bottom and to induce siltation in the bed of the gully.

The posts are spaced about 8 feet apart and placed at least 3 feet in the ground; it is necessary to carry out some excavation work to ensure that the structure is anchored well into the sides of the gully. These structures are planned so that the centre post is downstream from the side posts, thus creating the desired "notch" effect. The netting is pegged into a trench at least 6 inches lower than the bottom of the gully and finally a semi-permeable layer of brush and straw is established above the netting to induce siltation.

Brush Weirs.

The method of establishment for this type of structure is much the same as for the netting type structure. Posts are erected across the gully, a layer of straw is packed in a trench along the post line, and layers of brush built up below the post line and anchored with a series of wires stretched tightly across the gully and attached to the post. An earth weir may then be established across the gully above the line of posts and the brush serves as an overflow apron for the weir. A double row of posts is sometimes used, in which case the brush is packed between them.

Concrete or Masonry Structures.

The essential difference between these structures (Plate 87) and those previously described is that they are quite permanent; in soils which do not crack these structures will ensure stability without the necessity for the establishment of vegetation. However, they are more expensive to construct and in general are not suited for Queensland conditions where the worst gullying occurs on the black clay soils; concrete or masonry structures are rarely suitable on these soils because of the danger of undermining when runoff water enters cracks above the structure. Tunnels rapidly develop and collapse of the structures soon follows.

These structures are not recommended except in cases where vegetative control can be ultimately depended upon.

Conversion of Gullies to Farm Ponds.

In addition to the methods of dealing with gullies just described, the possibility of converting them to farm ponds should not be overlooked. With large gullies, ponds of moderate to large capacity can

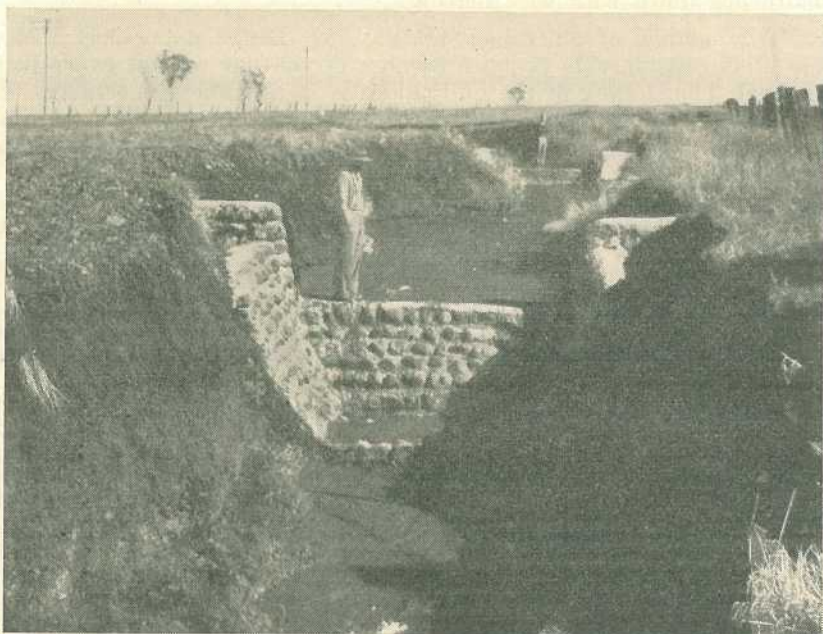

Plate 87.

A Series of Masonry Structures Used to Stabilise the Bed of a Long Deep Gully.—Three feet of soil were deposited above the nearest structure in one rain.

be constructed at comparatively low costs (Plate 88). Special precautions which require to be taken with respect to the construction of these ponds include—

- (a) The removal of any porous material from the bed of the gully at the point where the wall of the dam is to be built;
- (b) The protection of the overfall or inlet into the pond to ensure that gully erosion does not occur at this point; and
- (c) The provision of a stable spillway to prevent water passing around the side of the dam and re-entering the old gully at some unprotected point. Should this happen, the dam would be ultimately undermined. A suitable type of spillway consists of a long contour or diversion bank of adequate size to convey the water around the slope to a suitably prepared waterway or other safe point for disposal. In this way all overflow from the dam can be prevented from returning to the old gully.

Should it be necessary to re-admit water to the old gully below the dam, a specially prepared inlet should be provided. Care must be taken to select the most suitable site, as this side of the gully must be sloped to a gradient not exceeding 1 in 5, and should be sodded with grass and protected with straw and netting in the manner previously described. Attention must also be paid to the stabilization of the bed of the gully and for this purpose check dams or weirs of the type described herein may be required.



Plate 88.

A Farm Pond Constructed to Stabilise a Gully and at the Same Time Provide a Useful Reserve of Water.—Surplus runoff is carried across the field in a diversion bank to a vegetated waterway.

Concrete or masonry drop structures, including flumes, provide an alternative method of admitting overflow from the dam to the gully but are more expensive.



RADIO TALKS TO FARMERS

(Australian Broadcasting Commission)

4QR AND REGIONAL STATIONS

THE COUNTRY HOUR—Daily from 12 noon to 1 p.m.

4QG AND REGIONAL STATIONS

COUNTRY NEWS MAGAZINE—Every Sunday at 9 a.m.



Agriculture in the Callide and Dawson Valleys

O. L. HASSELL, Senior Adviser in Agriculture.

FOR the purpose of this article, the Callide Valley is accepted as that area of land in the Valley from the head of Callide Creek watershed to the township of Goovigen (Plate 89). In the case of the Dawson Valley, discussion herein refers to that portion of the Dawson River watershed from Theodore to Wowan.

From the early days of occupation of the Callide Valley until the early 1920's, the land was used for pastoral purposes. Resumed land and Crown land totalling over a million acres was thrown open from 1924 onwards for selection in small holdings under leasehold conditions. A few selections in the area were subsequently converted to freehold agricultural farms. The size of the selections when the land was thrown open in 1924 was mainly between 160 and 320 acres, but following an economic investigation of the lands in 1929, additional areas were granted to settlers to ensure a sound living based on dairying.

In October, 1923, the Queensland Government opened an Agricultural Demonstration Farm near what is now the township of Biloela in the Callide Valley as a step towards opening the land for closer settlement. The objectives of this Farm were to obtain information for prospective settlers on the best methods of clearing land and fencing and correct methods of land management, and investigation of the culture of crops which were likely to be best suited to the district. In 1924 this Farm became the Department's Cotton Research Station and in 1945 was converted to a Regional Experiment Station with considerably wider functions. The research and investigations on this property have had a considerable influence on the development and progress of agriculture in the Callide Valley. Indeed, many of its findings have been applicable to large areas of Queensland within the 30-inch rainfall belt.

In the Dawson Valley, land at Wowan, Deeford and Dululu was opened in 1912 as freehold agricultural farms and from 1916 onwards further areas were opened under perpetual lease. As in the Callide Valley, some tenants in this area also took the opportunity in 1929 to convert leaseholds to freehold agricultural farms. Although land in the Rannes-Baralaba district was on offer for years under perpetual

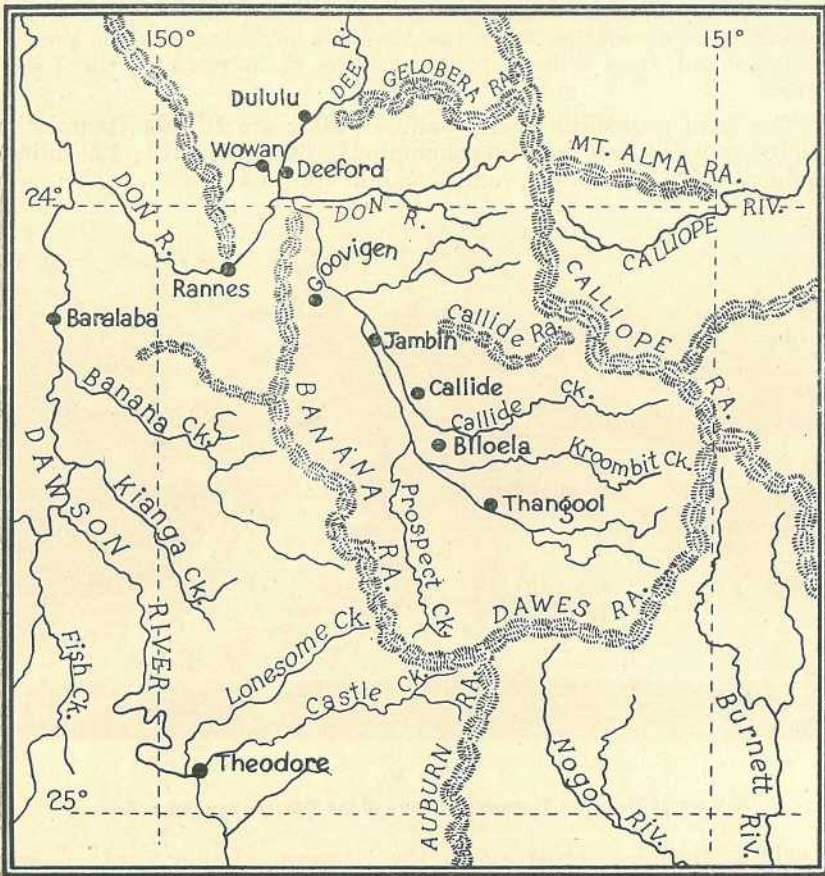

Plate 89.

Sketch Map of the Callide and Dawson Valleys.

lease tenure, the blocks were not selected until reclaimed from prickly pear by *Cactoblastis*. This land was again opened for selection during 1935-36 under perpetual lease prickly pear tenure. Additional areas were granted to Dawson Valley settlers in 1935.

The Theodore Irrigation Settlement was opened in 1927 on what was originally a grazing selection owned by Mr. W. G. Woolrych. The area was cut into 264 blocks of an average area of 13 acres for irrigation, and 109 dry blocks of an average area of 211 acres.

In the Wowan district the land acquired was mainly portions of grazing selections forming Calliungal expired leaseholds, while at Baralaba the area thrown open consisted of lands unoccupied previously because of prickly pear infestation and resumed areas or expired holdings of parts of a number of properties. The Baralaba-Kokotungo area was cut into blocks of 1,000 to 2,000 acres, the size depending on the quality of the land and the estimated cost of development.

Both the Callide and Dawson Valley settlements are reasonably well provided with rail transport and all-weather main roads. In the Dawson Valley the railway terminates at Theodore, and in the Callide

Valley at Lawgi. State highways lead from both Valleys to the city of Rockhampton, as well as from the township of Biloela to the port of Gladstone and from Biloela to Monto, the main town in the Upper Burnett.

The main townships in the Callide Valley are Biloela (population 940; 102 miles by rail from Rockhampton), Thangool (163; 109 miles), Goovigen (103; 78 miles), and Jambin (66; 85 miles). The more



Plate 90.

A View of Theodore Township, Centre of the Dawson Irrigation Area.

important business centres in the Dawson Valley are Wowan (population 332; 52 miles from Rockhampton), Theodore (386; 148 miles), and Baralaba (465; 89 miles from Rockhampton). Population figures represent the position at the census of June, 1947.

CLIMATE.

The following table gives average meteorological data for the townships of Biloela, Theodore and Wowan:—

BILOELA (RECORDS FOR 19 YEARS).

	Jan.	Feb.	Mar.	Apr.	May.	June.	July.	Aug.	Sept.	Oct.	Nov.	Dec.	Year.
<i>a</i>	92.1	87.5	88.9	84.1	77.1	70.6	71.5	75.8	81.9	84.9	99.3	91.0	83.0
<i>b</i>	68.0	66.3	62.3	56.4	47.9	45.2	40.7	40.4	48.3	54.7	61.5	65.4	54.7
<i>c</i>	456	475	275	198	169	192	132	57	83	174	277	360	2,848

THEODORE (RECORDS FOR 15 YEARS).

<i>c</i>	346	440	272	225	177	165	159	68	65	148	325	409	2,799
----------	-----	-----	-----	-----	-----	-----	-----	----	----	-----	-----	-----	-------

WOWAN (RECORDS FOR 21 YEARS).

<i>c</i>	432	524	258	223	128	267	158	72	80	171	288	410	3,011
----------	-----	-----	-----	-----	-----	-----	-----	----	----	-----	-----	-----	-------

a = mean maximum temperatures,
b = mean minimum temperatures,
c = average rainfall in points.

Average temperatures for Theodore and Wowan are not available, but would not vary greatly from those shown for Biloela.

Of the rainfall, approximately two-thirds of the total falls between the months of November and April inclusive. Unfortunately, the rainfall is erratic and the real position is not as satisfactory as the picture presented by the averages suggests. During the summer months, periods of up to six weeks may elapse when little or no rain is registered. These rainless periods during a time of the year when temperatures are high cause wilting of crops.

The winter rainfall is light and unreliable, and this makes summer fallowing an essential part of the agricultural programme in the area if winter crops are to be grown.

The summer weather is at times rather trying, as screen temperatures may exceed 100 deg. for several days in succession. The winter is mild and very pleasant. During the winter months frosts occur, usually from the middle of July to the end of August. Occasional frosts have been known to occur as early as April and as late as October. Westerly winds are experienced also during these months, but are not generally considered to play a great part in the severity of the winter.

The prevailing wind is from the south-east.

SOILS AND VEGETATION.

There is a fairly close correlation between soil type and vegetation in the district. The soil types may be divided into (a) alluvials, (b) brigalow soils, (c) softwood scrub soils, (d) dark grey-brown clay loams of the plains, and (e) shallow gravelly clay loams.

(a) *Alluvials*. These are extensive and important soil types which have their maximum development along the main streams. Sandy loams occur near the banks, but the more important types away from the banks are deep, dark-grey clay loams and clays with a good physical condition consequent on a good structural development. These soils have a high fertility and have proved to be very productive. Nevertheless, crop rotation, including several years of pasture, is needed to maintain their favourable physical condition, which is an important factor contributing to their high productivity. The principal crops grown on these soils are grain sorghum, wheat for grain, cotton, and winter and summer fodder crops.

The vegetation is grassed open forest (Plate 91) and the trees consist principally of blue gum (*Eucalyptus tereticornis*), coolibah (*E. coolabah*) and Moreton Bay ash (*E. tessellaris*). Some of the areas are liable to occasional flooding.

These alluvials merge into extensive areas of flat country, in which the dominant tree species is poplar box (*E. populifolia*). This country is an extension of the alluvials, but the soil types are characterised by comparatively shallow profiles, a poor physical condition and only moderate fertility. The soils are grey and dark-grey clays, and in their natural state are tight and compact. Because of their heavy texture and poor structural development, they are not readily permeable to water, so water tends either to run off or to pond on these areas in depressions. They will grow good crops of grain sorghum, wheat and the usual winter and summer fodder crops if the ground is properly worked.

(b) *Brigalow soils*. The country rises gradually from the alluvial flats into broad areas of grey-brown clay loam soils carrying principally brigalow trees (*Acacia harpophylla*), with wilga (*Geijera parviflora*) in the undergrowth. The surface horizon of these soils is friable and has a fairly well developed structure. Although the physical condition of the surface soils in their natural state is good, they are liable to deteriorate under intensive cultivation. Crop rotation including several years of grassland must, therefore, be adopted to maintain a good physical state. Although the subsoils are mostly clays, the soils drain fairly freely and waterlogging seldom occurs. Their productivity is good and in normal seasons very satisfactory crops of cotton, sorghum, millets, and other summer crops can be produced.



Plate 91.

A Typical Blue Gum Alluvial Flat in the Callide Valley.

Large areas of this country are laid down to Rhodes grass, which has proved very suitable for this soil type.

In some places, belah trees (*Casuarina lepidophloia*) constitute an appreciable percentage of the brigalow scrub. This association usually indicates the best type of brigalow scrub soil.

Another type of brigalow country on areas of low elevation is characterised by dark-grey soils and melon-hole formation. The soils are friable self-mulching clays of fair to good fertility, but inferior to the brigalow soil previously discussed. Provided the drainage is satisfactory, these soils can be cultivated and will grow good agricultural crops, such as sorghums, and pastures. Usually the areas must first be graded to smooth out the uneven surface. These soils usually cover extensive areas at the foot of ridges. The subsoils are generally a heavy sticky clay.

(c) *Softwood scrub soils*. On the slopes of the hills, the softwood scrub type of vegetation (Plate 92) is usually found above the brigalow scrub of the lower slopes. Many tree and shrub species comprise these

scrubs; some of the commoner species include Flindersia (*Flindersia collina*), scrub ironbark (*Bridelia exaltata*), whitewood (*Atalaya hemiglauca*) and messmate (a species of *Eucalyptus*).

The soils are friable, red or brown loams and clay loams of volcanic origin, fairly deep and for the most part merging into a clay subsoil. Fertility is good, and when soil moisture is ample crop growth is excellent. Under these conditions, however, cotton plants may develop an excessive amount of undesirable rank growth. The soils do not retain soil moisture like the brigalow soil types and in dry seasons are inferior to the latter for crop growth.



Plate 92.

A Softwood Scrub in the Callide Valley.

(d) *Dark grey-brown clay loams of the plains.* These areas consist of open plain country (Plate 93) and in the aggregate cover a large acreage in the valleys. The vegetation is mainly grass with a few scattered clumps of bauhinia (*Bauhinia hookeri*) and poplar box (*Eucalyptus populifolia*). The soils are mainly friable self-mulching types that lend themselves readily to cultivation. They are very fertile and are capable of high production in seasons of satisfactory rainfall. For the most part they have a good physical condition and are not prone to waterlogging except in some places in very wet seasons.

(e) *Shallow gravelly clay loams.* These soils are usually very shallow and the vegetation is grassed open forest. The trees are mainly ironbark (*Eucalyptus melanophloia*), yellow jack (*E. ochrophloia*), and bloodwood (*E. corymbosa*). These soils are associated with elevated country in various parts of the district where grazing is followed (Plate 94). The carrying capacity of the pastures on them is good and the nutritive value of the feed is satisfactory. As well as native grasses, a wide variety of native legumes occur on these soils.

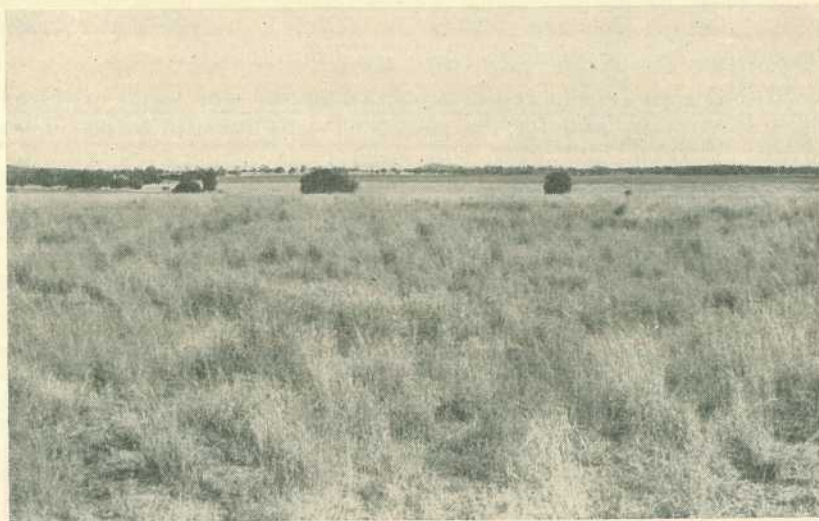

Plate 93.
Plain Country in the Dawson Valley.

Except in isolated cases, soil erosion does not constitute a major problem at present in the district. Gully erosion has done considerable damage on some farms and sheet erosion has been noted on the slopes. With the expansion of the wheat growing industry in the valleys under the system of bare summer fallows, erosion may prove to be a much greater hazard in the future, particularly where clay loams on the slopes are cultivated.



Plate 94.
Grassed Open Forest, with Ironbark Trees in Foreground, near Biloela.

WATER FACILITIES.

Irrigation.

The main irrigation area is at Theodore, where there is an area of 3,526 acres reserved for irrigation purposes. Water for this scheme is pumped from the Dawson River adjoining the area. A weir (Plate 95) across the river at the township backs the water up the river for a considerable distance. Flood and furrow irrigation are the only methods practised in this area. Water is carried from the pumping station to the various farms in open ditches (Plate 96).

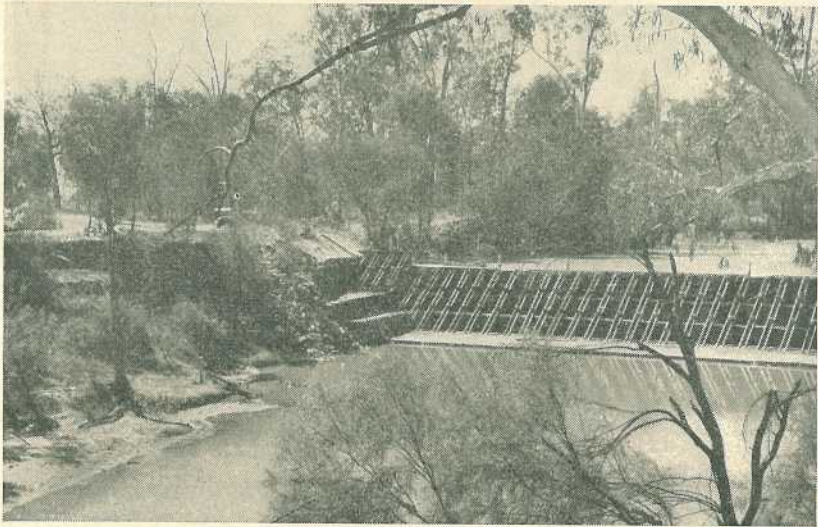

Plate 95.

The Main Weir on the Dawson River at Theodore.

The construction and upkeep of the main channels is the responsibility of the Irrigation Commission and the supply of water to each farm is controlled. Farmers notify the Irrigation Commission of their intention to irrigate and the supply of water to each block is regulated accordingly.

The crops grown under irrigation on this settlement are lucerne, cotton, broom millet, wheat for grain, grain sorghum, winter and summer fodder crops, truck crops and citrus.

In other parts of the Valleys there are isolated irrigation plants, where water is pumped from wells, rivers and creeks. In these areas the crops grown are mainly lucerne, cotton, fodder crops and truck crops. There is scope for expansion of irrigated crops in these areas.

A weir has been erected on the Dawson River at Moura, and nearby the Queensland-British Food Corporation has established a large pig farm.

Water for Stock.

On individual properties in the district water is obtained from creeks, rivers, bores, wells and earth tanks. On properties where water is not obtainable from streams or underground sources, earth tanks can be constructed at a reasonable cost. In most cases these tanks have

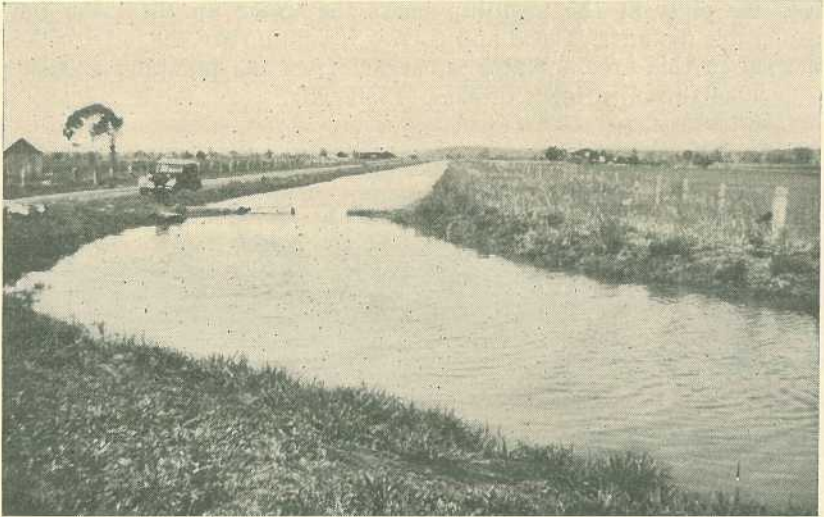

Plate 96.

The Main Supply Canal, Theodore Irrigation Area.

been found very satisfactory, and if constructed to dimensions adequate for the size of the herd, they will hold enough water to last through most dry periods. These tanks are mainly constructed by contractors with heavy earthmoving equipment.

Difficulty in obtaining an adequate water supply is commonly experienced in the brigalow country, and earth tanks or dams have particular application in these areas.

[TO BE CONTINUED.]

MACADAMIA IMPROVEMENT.

Progress in the Departmental plan to expand the Macadamia or Queensland nut industry on a firm basis has been announced by the Minister for Agriculture and Stock (Hon. H. H. Collins) to-day.

Mr. Collins said that in a recent survey of Macadamia nut plantations some excellent types of trees had been found. Some produce thin shelled nuts suitable for dessert, while others bear thicker shelled nuts with a large kernel and well suited to processing.

Seed from a number of the more distinctive tree types has been planted at the Redlands Experiment Station at Ormiston and next autumn the seedlings will be grafted with scion wood cut from selected trees. These grafted trees will then be used for an orchard planting at the Maroochy Experiment Station at Nambour. Later, nurserymen will be able to obtain good scion wood from the orchard to build up supplies of first class propagating material.

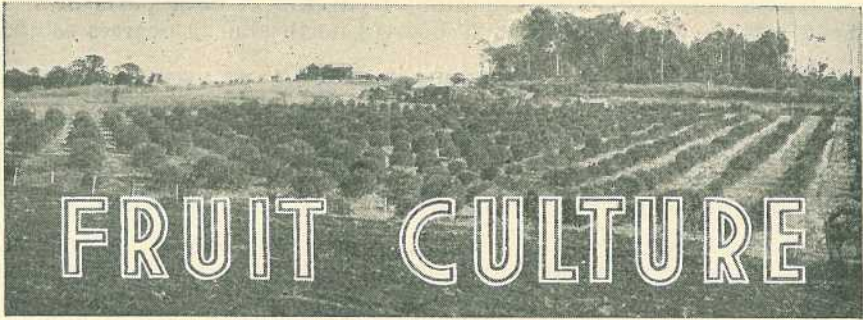

Banana Growing in Queensland.

J. MCGREGOR WILLS, Senior Adviser in Horticulture.

BANANAS have been grown for many years along the coastal strip of Queensland from the New South Wales-Queensland border to Cairns, a distance of some 1,200 miles. Climatic conditions vary considerably within this area and cultural practices differ a great deal from district to district. However, most of the crop is produced south of Gympie at the present time, mainly because of the area's close proximity to the more important metropolitan markets.

During the first quarter of the present century, ample virgin land was available for bananas, but much of this has now been cropped. The scarcity of new virgin land in existing producing areas is such that sound cultural practices and efficient soil conservation methods are essential if the annual cut is to be maintained at its present level.

HISTORICAL.

The banana has been an important food plant throughout the world for a very long time; the fruit is sculptured on the ancient monuments of Egypt and Assyria, while Alexander the Great found the plant growing in India during his campaign in the fourth century B.C. The crop has been traditionally linked with the Garden of Eden as the tree of knowledge of good and evil, hence the names given by the early botanist Linnaeus to two well known species—*Musa paradisiaca*, the plantain, and *Musa sapientum*, which includes most of the tall, cultivated banana varieties of today.

The most widely grown variety in Queensland is the Cavendish (*Musa cavendishii* Lambert), which is native to Southern China. In 1826, plants were taken from this area to Mauritius and three years later two were transferred from Mauritius to England. The Duke of Devonshire obtained one of these and planted it in his glasshouse at Chatsworth, where the plant created considerable interest. The specific name *cavendishii* is derived from the Duke of Devonshire's family name. In 1838, offshoots from plants at Chatsworth were taken by a missionary, John Williams, from England to the South Sea Islands, where the fruit soon became very popular. The natives of these Polynesian islands later distributed planting material far and wide and it is probable that existing Cavendish banana plantations in most Pacific countries originated from the single plant grown by the Duke of Devonshire in England 100 years ago.

The banana is now an important food crop in most parts of the world between the latitudes of 29 degrees north and 29 degrees south.

STRUCTURE OF THE BANANA PLANT.

The banana belongs to the Musaceae, a family of monocotyledons which is closely related to such ornamental plants as *Eavenala*, the traveller's tree. In Queensland, the genus *Musa* is represented by three indigenous species, chief among which is *Musa banksii*.

The cultivated banana (Plate 97) is a broad-leaved, perennial plant some eight to twenty feet in height. The stem is entirely below ground level and is known technically as a corm. The long, fleshy roots (Plate 98) arising from the corm develop particularly well in deep, friable well-drained soils with a high humus content. Under suitable conditions, the root system extends laterally for several feet from the base of the plant, but most of the roots are shallow, only a few penetrating to a depth of 30 inches and then only if the subsoil is sufficiently open.

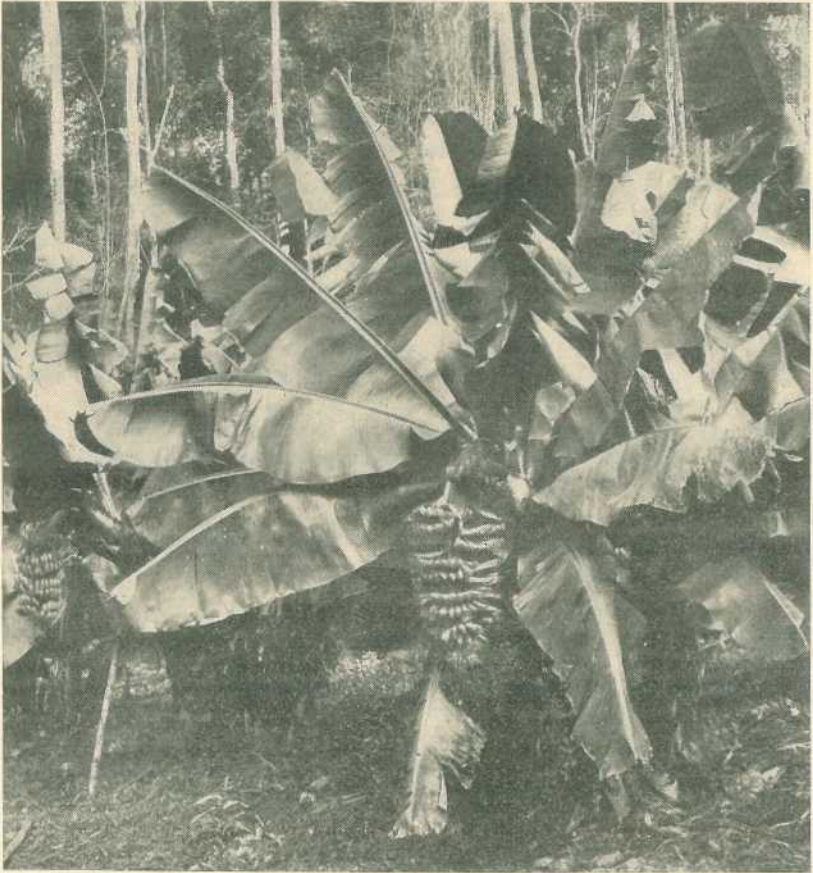

Plate 97.

Cavendish Banana Bearing a Plant Crop.—Bunch at right about three weeks old; bunch at left about 10 weeks old.

The leaves develop centrally from the corm (Plate 99), and the overlapping petioles form a cylindrical false stem (pseudostem). Each successive leaf grows upwards within this pseudostem until it emerges from the "throat" of the plant. At this stage, the broad blade of the leaf is tightly wrapped around a strong fibrous midrib. When growth is vigorous, the leaf does not unfurl until it is clear of the "throat," but during cold or excessively dry weather unfurling may begin earlier and induce what is generally known as a compacted pseudostem. As the plant ages, the older leaves die and fall back over the pseudostem.

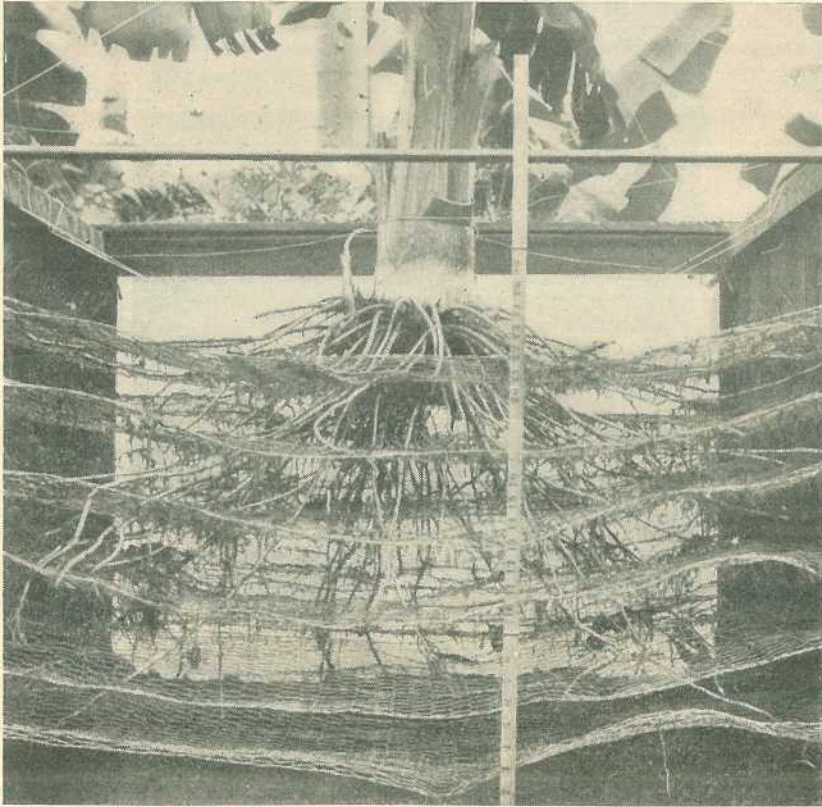

Plate 98.

Root Distribution.—Roots are about one-third of an inch in diameter and the same thickness throughout.

The inflorescence is borne on a stalk which arises from the corm in much the same way as the leaves. The flowers are grouped in hands arranged spirally around two or three feet of the stalk. The flowers are potentially bisexual, but female characters are dominant in the flowers near the base of the stalk and recessive towards the tip. Thus the flowers from base to apex are often referred to as female, hermaphrodite and male respectively, according to their position on the stalk. When the inflorescence emerges from the throat of the plant, the basal fruits are already well developed. Climatic conditions and plant vigour influence the number of hands, the number of flowers which produce fruit on each hand, and also the size of the individual fruits.

The cultivated banana is a self-sterile plant produced by age-long selection in countries where plants of the genus *Musa* were indigenous. Its survival in spite of the lack of seed is due to the practicability of reproducing the plant by vegetative means and its importance as a food crop. Reproduction is normally effected by offshoots from the parent corm, which are generally known as "suckers."

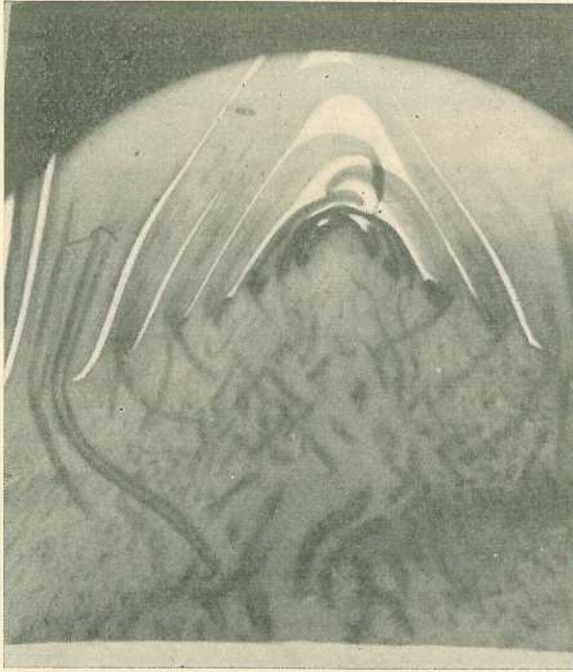

Plate 99.

Longitudinal Section Through Growing Point of the Corm.—
The Youngest leaves grow out from centre.

VARIETIES.

The Cavendish variety is a dwarf type which is tolerant of high winds and bears very heavy crops of fruit. It is immune to Panama disease, which commonly affects tall growing varieties such as Lady Finger and Sugar. The semi-dwarf Mons Mare and the very similar Williams' Hybrid are mutations from the dwarf Cavendish, the former being first selected for commercial production at Buderim Mountain in Queensland and the Williams' Hybrid near Coff's Harbour in New South Wales. Mons Mare and Williams' Hybrid attain a height of from ten to sixteen feet when grown on suitable soils. Under comparable conditions, the bunches of Mons Mare and Williams' Hybrid are larger than those of Cavendish, the fruit grades better and the hands are more widely spaced. The Mons Mare and Williams' Hybrid bananas are more tolerant of marginal soil and climatic conditions than Cavendish. They are generally preferred in commercial production south of Brisbane, particularly in higher altitudes where Cavendish may fail to grow satisfactorily.

The tall varieties, Lady Finger (Plate 100) and Sugar, are generally grown on frost-free river flats. However, the severity of Panama disease in this type of country has induced some growers to plant the Lady Finger on higher land which would normally be planted to dwarf and semi-dwarf varieties such as Cavendish and Mons Mare (Plate 101). Provided the tall varieties are effectively protected from high winds by the topography of the plantation, they do well on the higher slopes.

The Embul Hondarawala, imported from Ceylon some years ago, is the tallest variety grown in Queensland, but commercial production is still on a small scale. It attains a height of 16 to 18 feet and can be grown successfully either on alluvial flats or on slopes. Owing to its great height, slender pseudostem and very large bunch, efficient propping is impracticable and heavy losses are inevitable if the plantation lacks good natural protection from strong winds. The fruit is particularly attractive, has an excellent flavour and carries well to distant markets.

The Gros Michel, although the most important banana variety in world trade, is not grown commercially in Queensland, though isolated plants still exist in North Queensland. Its lack of importance is due primarily to a marked susceptibility to Panama disease. Other varieties



Plate 100.

Lady Finger Bananas at Pimpama, South Coast District.

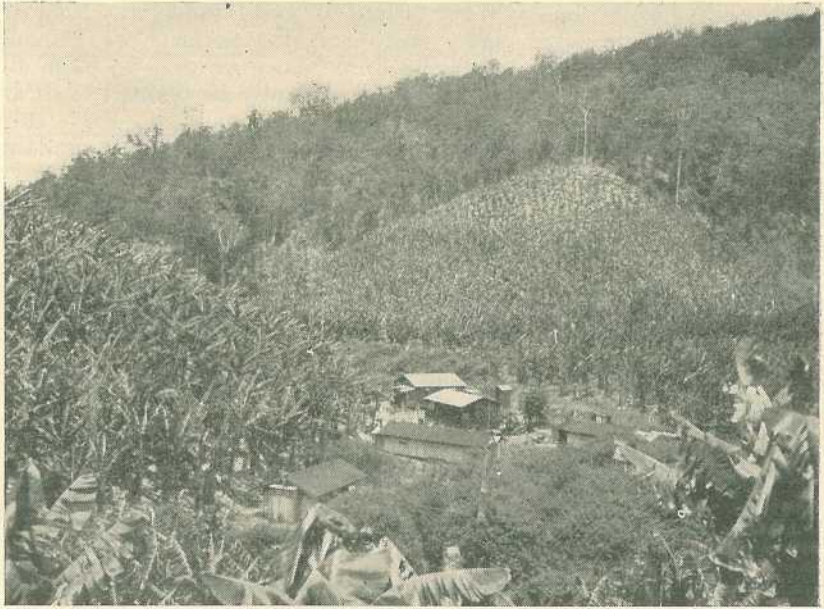

Plate 101.

Banana Plantation at Upper Coomera.—Lady Fingers at left foreground; Mons Mare at near centre.

known in Queensland but of little commercial interest are Red Colombo, Red Dacca, Green Rajah, Ducasses' Hybrid, Blue Java, Lubin, and Plantain.

The main characteristics of the more important commercial varieties of banana in Queensland are given in Table 1.

TABLE 1.

COMMERCIAL VARIETIES OF BANANA IN QUEENSLAND.

Variety.	Pseudostem.	Leaves.	Bunch.
Cavendish ..	6 ft. high; green but heavily pigmented	5 ft. long; up to 24 in. wide	Medium to large; 8-10 hands
Mons Mare, Williams' Hybrid, Viemama	10-15 ft. high; robust; green, but heavily pigmented	7 ft. long; up to 30 in. wide	Long and cylindrical; 10-15 hands
Sugar	12-14 ft. high; light green	6-7 ft. long; about 20 in. wide; green edges tinged with pink	Small; 5-6 hands; fruit short
Lady Finger ..	14-18 ft. high; sturdy; light-green and lightly pigmented	8ft. long, 30 in. wide; light-green; slightly drooping habit	Medium; 5-8 hands; fruit dumpy
Embul Hon-darawala	16-18 ft. high; tapering to apex; clear, light-green with light pigment	10-11 ft. long, 30 in. wide; new leaves erect	Large, long and cylindrical; fruit well-spaced; abruptly curved at base; tips pointed

SELECTION OF LAND.

As would be expected from the type of country in which plants of the genus *Musa* naturally occur, the cultivated banana requires a very fertile soil which is well drained and free from waterlogging. In Queensland, the crop is grown mainly in the sub-tropics, where the climate is characterised by a summer rainfall. As the banana cannot tolerate dry conditions for any length of time, and as such conditions frequently occur during spring and early summer, it is imperative that the subsoil be fairly retentive, at least in districts where irrigation is impracticable.

Important factors in the selection of land for banana production are a rainfall of from 50 to 100 inches per annum, high soil fertility, and a subsoil which, while not impeding drainage, holds sufficient moisture to tide the plant over dry periods whenever they occur. These conditions are best satisfied by virgin soils which have not been exploited for horticultural purposes and are therefore rich in plant nutrients, contain large amounts of organic matter, and possess a good structure. For the most part, therefore, bananas are preferably grown as a developmental crop on land which is to be used for other purposes when the cropping period for bananas has ended.

In North Queensland, varieties such as Cavendish and Mons Mare are frequently grown on alluvial soils. In southern Queensland, however, tall varieties such as the Lady Finger are preferred on this type of country.

Good banana plantations occur on soils derived from many different types of rock. For high productivity and long plantation life, however, the basaltic soils are considered most suitable for the crop.

When selecting land, growers use the natural vegetation as a guide to its suitability for bananas. Potential banana soils occur both in rain forest and open forest associations.

The rain forest (Plate 102) or scrub soils are usually deep, friable loams, rich in humus, and well drained. When derived from basalt they may be stony on the surface, but this is not a serious drawback as the stones impede surface runoff during heavy rains and therefore minimise soil erosion even on steep slopes. Dense vine growth and tall, straight softwood timbers such as carrabeen, crow's ash, bolly gum, and cedar are typical of this type of country throughout the State. During the past twenty-five years most of the rain forest in southern Queensland has already been cleared, and in some districts it is now difficult to find areas of virgin scrub land for bananas, except in relatively inaccessible situations at the heads of gullies or high up on mountain slopes. In central and northern Queensland, suitable land of this type is still available in quantity and will doubtless be used in future.

Former scrub soils now under pasture may be utilised for bananas, provided the land is ploughable and can be prepared for planting at a reasonable cost. The steeper slopes in this type of country which were formerly used for bananas and are now covered by lantana and sapling regrowth up to seven years old may also be cleared and planted to the crop. In both cases heavy applications of fertilizer will be needed for maximum production.

Open forest soils carrying hardwood trees are normally less fertile than rain forest soils in areas where bananas are grown commercially. However, if the land is selected carefully and the plantation managed efficiently, payable crops can be produced on them. In the open forest soils, trees such as bloodwood, grey gum and tallow-wood, especially when accompanied by dense undergrowth, are indicators of reasonably deep, well-drained, friable loams containing large amounts of organic matter. Open forest soils supporting mahogany, turpentine or spotted

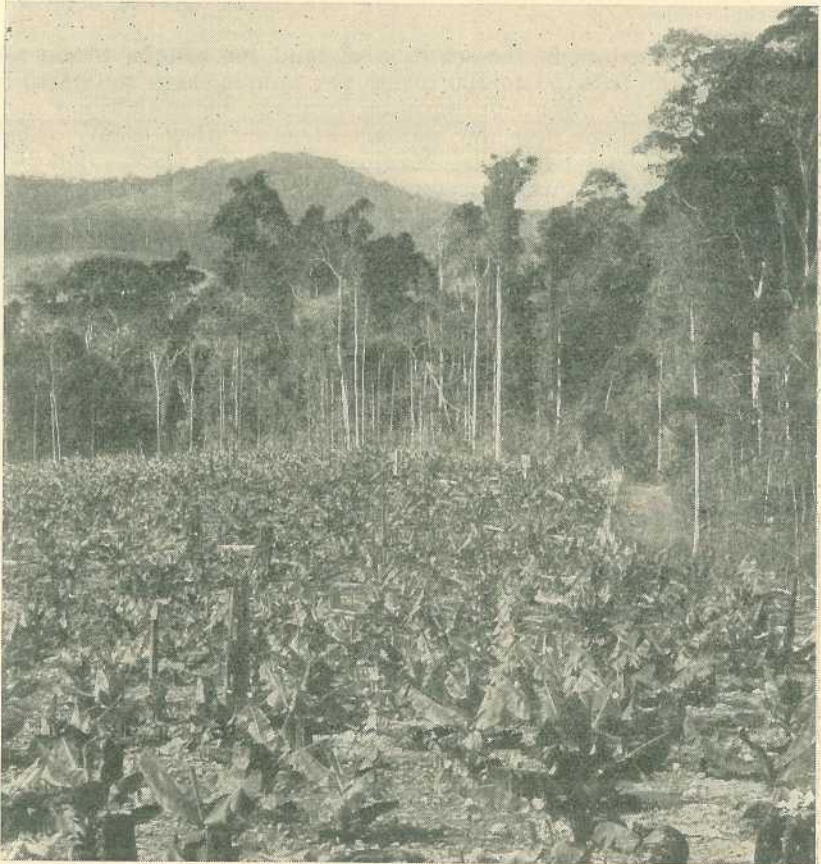

Plate 102.

Cavendish Banana Plantation, South Coast District, on Virgin Rain Forest.

gum are usually shallow and erode rapidly if precautions are not taken to prevent soil wash. In any case they rarely produce more than one plant and two ratoon crops unless very heavily fertilized.

Alluvial soils vary considerably in coastal districts. Some are relatively fine to coarse silts overlying a porous subsoil; others are medium to heavy loams overlying clay. The fertility of these soils depends very largely on their origin. Except in very wet areas the lighter alluvials are of little value for bananas unless the grower can

install irrigation equipment and is prepared to use it regularly in conjunction with heavy fertilizer applications. The heavier alluvials are capable of producing good crops of bananas provided care is taken to provide the requisite drainage. In some parts of southern Queensland, excellent crops of tall varieties are grown on heavy but relatively shallow soils. The management of plantations on such soils requires considerable skill on the part of the grower.

SELECTION OF SITE.

The banana plant requires ample soil moisture and relatively high temperatures for its development. Both are influenced by the elevation, aspect, and natural shelter of the plantation area. Freedom from frost (Plate 103) is essential, although tall varieties such as Lady Finger and Sugar are rather more tolerant of cold conditions than the



Plate 103.

Lady Finger Bananas at Currumbin, Showing Frost Injury.

dwarf and semi-dwarf types. This tolerance of cold conditions in tall varieties is mainly due to the rapid growth of the plants during the first summer after planting; the susceptible crown and leaves are well above ground level where cold air accumulates during winter. In southern Queensland there is a distinct segregation of varietal plantings in terms of altitude as follows:—

0—1,000 feet	Lady Finger and Sugar
400—1,000 feet	Cavendish
400—1,300 feet	Mons Mare and Viemama
1,000—1,500 feet	Williams' Hybrid

Sites affected in winter by down-flowing currents of cold air from hills are unsuitable for bananas, as severe chilling retards plant growth, delays bunching, and causes fruit blemishes. Tops of ridges should not be cleared for bananas if the plants will be exposed to cold winds.

Except in North Queensland, where aspect is less important, plantations should face from east to slightly west of north. Such aspects are naturally warm and moist since they are open to the morning sun and protected from strong southerly and westerly winds by either topography or natural timber.

PREPARATION OF THE LAND.

In virgin rain forest or scrub, undergrowth is usually brushed and the standing trees are felled between April and June so as to allow ample time for the timber to dry out before burning between September and November. In open forest, clearing may be delayed until June or July, since most hardwood trees burn well within a few weeks of felling. In replant land, the lantana is brushed and young saplings are cut down about six weeks before the actual burn, when, if the day is calm and sunny, an effective clean-up can be expected. Old pasture land should be rough-ploughed across the slope during early spring and as much grass as possible worked out of the soil before planting; any blady grass or bracken must be grubbed with a sharp mattock to ensure its destruction.

FELLING AND CLEARING.

In preparing virgin land for bananas, the undergrowth should first be cut close to the ground so that no stakes will escape the burn and remain as dangerous obstructions in the plantation when it is established. As far as possible, trees should be felled across the slope, for scorched logs left in this position after a burn reduce soil drift down the slope. A good burn can only be expected if all upright branches are lopped and stacked around the larger timber before starting the fires. The cost of brushing and felling rain forest varies from £4 to £6 per acre at the present time, but inexperienced growers may engage expert timber fellers to do the work. The cost of brushing and felling open forest is much greater and may reach £40 per acre in heavily timbered country.

CONTOURING.

As bananas are very largely grown on steep slopes in the more important producing areas, steps must be taken to minimise soil erosion by controlling the flow of surface water during periods of heavy rain. Contouring is, therefore, a necessary practice in many districts.

In preparing land for contour planting, it is first necessary to construct a contour drain above the proposed plantation site, to divert surface water from the higher slopes to a suitable outlet such as a grassed gully. Below this master drain, the rows are marked out on near-contour lines with a fall of 2 in 100 and shallow drains are dug between every third and fourth row of bananas. These drains carry surface water slowly from the plantation and usually lead to the same natural runway as the master drain.

In new plantings, the rows are spaced at intervals of 9 to 14 feet, depending on the requirements of the variety to be grown. With the closer spacings (9 to 11 feet), the drains should be constructed between the fourth and fifth rows, the eighth and ninth rows, and so on down

the slope; with wider spacings, the drains should be made between the third and fourth rows, the sixth and seventh rows, and so on. The depth of the drain is from 15 to 18 inches, depending on the rainfall of the district.

An alternative method of marking out the area is to form the contour drains first and then set out the plant rows between each pair of drains in the most practicable way. If the drains are far from parallel, it will be necessary to provide one or more short-spur rows to maintain the required plant and row spacings.

In banana areas already established and not planted on the contour it is still practicable to install cross drains to divert surface water and reduce soil erosion. These drains need not necessarily follow the plant rows and may deviate from the normal fall of 2 in 100, in order to avoid existing stools. The construction of such cross drains involves little labour and does much to ensure a relatively long producing life for the plantation.

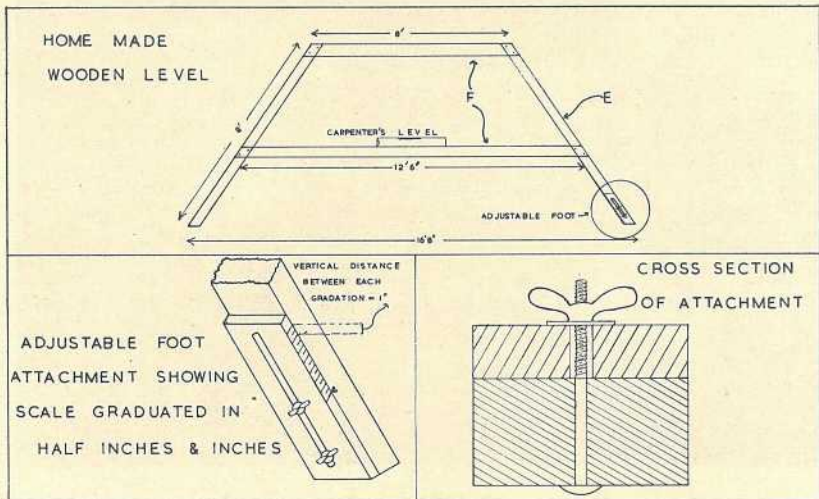

Plate 104.

"A" Frame—Plan and Specifications.—The "A" frame is useful in hilly country for running contour lines when preparing land for planting.

USE OF THE "A" FRAME.

For contour work one of the simplest and most inexpensive types of equipment is an "A" frame (Plate 104), which may be made of pine or any other light timber and provided with a spirit level at least 12 inches long. The legs "E" are made of 3 x 2 timber, with two horizontal bars "F" of 3 x 1 mortised into the legs. A frame with an 8 ft. top bar 49 inches from the ground and a 12 ft. 6 in. bottom bar is convenient for a man of medium height to handle, but the heights may be varied to suit the individual. For convenience in calculation, the bases of the legs should be 16 ft. 8 in. (200 inches) centre to centre. A short movable extension is bolted to one of the legs so that it can be adjusted to give the desired fall; a 4-inch extension on the frame will give a fall of 2 in 100.

To mark out the contour line, a peg is set in the ground at the highest point of the land to be contoured. The extension of the leg of the "A" frame having been set for the required fall, the shorter leg is placed on the ground at the base of the peg and the frame moved around, using the attached spirit level to keep it horizontal, until the longer leg just touches the ground. A peg is then driven in at this spot and the operation repeated using this peg as the base for the short leg and a third peg driven in where the longer leg touches the ground. This procedure is followed until the first line has been pegged. Next select what appears to be the least slope down the hillside and measure



Plate 105.

Contour Planted Bananas, North Coast District.—Note interrow drain and the mulch cover of blady grass.

off a distance equal to the row spacing which has been decided on. Using this as a starting point, mark out the next contour line, and so on down the slope until the whole area has been completed.

The contour lines (Plate 105) so marked out will usually twist about across the slope, and the distance between them will vary according to the unevenness of the land. The length of the rows will therefore differ and the planting positions when marked out will not always correspond from row to row. This is not a disadvantage, as the staggering of the plants will assist in impeding the downward flow of water between drains.

[TO BE CONTINUED.]

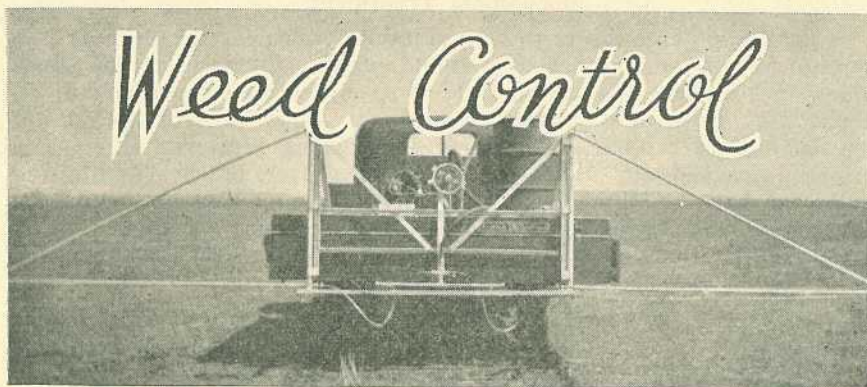

Control of Eucalypt Seedlings and Suckers.

B. EASTERBROOK (formerly Assistant to Weeds Officer).

THE method generally used to clear country of eucalypts is ring-barking, followed in due course by removal of the dead trees if the land is needed for cropping. Where the original forest consists of large trees, ringbarking usually results in a good kill of treated trees. Some suckering occurs, chiefly from just below the place where the trunks were "rung," but on the whole regrowth from large trees is not a serious problem. Following ringbarking, the land may be sown down to pasture plants, or native grasses allowed to thicken up to form a pasture. As the pasture is developing, a dense crop of eucalypt seedlings often appears, and in the absence of competition for light, moisture and soil nutrients by adult trees, these develop rapidly and frequently within four years are 10 feet or more high.

Attempts at eradicating young trees in the past have largely followed three methods:—

- (1) *Brushing.*—This is ineffective, as the seedlings sucker readily when rung or cut down. The size a eucalypt must reach before it loses its power of prolific suckering when rung or cut down probably varies greatly according to the species and with various other factors.
- (2) *Burning.*—This usually gives a negligible kill of the eucalypts and encourages the spread of weeds such as bracken.
- (3) *Poisoning with arsenic.*—The plants are frill poisoned or cut down and the butts swabbed with an arsenical solution. Good results are sometimes obtained with this method, particularly if the poisoning is carried out during the period from May to July. However, it is rather variable in its results and has the serious disadvantage of requiring the exclusion of stock from a treated area until some good falls of rain have occurred.

In view of the deficiencies of the methods described, attempts have been made to find other ways of dealing with seedlings and with young trees which have suckered after ineffective brushing or poisoning.

Mechanical Treatment.

The bulldozer appears to be a suitable implement for clearing this type of vegetation. It has been found possible, by striking the stems a few inches above the soil surface, to remove trees and suckers up to about five inches in diameter without any disturbance of the topsoil by the bulldozer blade. All parts from which regrowth may occur are then dragged out. Small stems may bend over, but by running the bulldozer back in the opposite direction these can be dragged out. Odd stems will break off and regrowth may occur on these, but it appears likely that the amount of regrowth which can be expected after bulldozing is very slight.

Various other mechanical means, such as dragging heavy cables between tractors, have also been devised for clearing land of seedlings and suckers, and these appear to be fairly successful.

The area treated is ready immediately for cultivation or for sowing down to pastures and in this respect mechanical methods have a big advantage over chemical methods. However, in some situations it is not possible to use mechanical methods and in these cases a chemical which will kill the regrowth satisfactorily and be harmless to stock is needed.

Chemical Treatment.

Weedkillers of the hormone type, such as M.C.P.A. and various formulations of 2,4-D, have been tried at numerous strengths and rates of application as foliage sprays on seedlings and suckers up to nine feet high, but in no case has a worthwhile degree of control been obtained.

One of the more recent materials, 2,4,5-T, reputed overseas to be particularly effective on trees and shrubs, would have a limited usefulness as a spray for eucalyptus control because of its cost, but experiments on swabbing and frill-poisoning with this weedkiller, both alone and in combination with 2,4-D, are being carried out. Conclusive results have not yet been obtained but the following notes may be of use to anyone wishing to test hormone weedkillers on a small scale on eucalypts.

No difference has been observed between frill-poisoning and swabbing, and as the latter is generally quicker, it is to be preferred. The stems should be cut off as near to the ground as is possible and the poison applied soon after cutting. The best method of applying it is to use a knapsack spray pump with a single nozzle giving a cone-shaped spray. The ordinary double cyclone nozzles will do if one is blocked. A high pressure should be maintained, and a quick, efficient cut-off valve is essential. The nozzle should be held two to three inches above the stump and a small amount of poison sprayed on to the stump. For stems up to four or five inches in diameter, an average of one fluid ounce of solution per stem is actually a little more than is necessary and no better kill results from applying more. It is necessary to cut off and poison all stems, however small they may be. If any small stems are left intact after the main stems have been severed, regrowth may occur from the base of these.

Salts and esters of 2,4-D have given a poor kill. A high percentage kill with 2,4-D on blue gum has been reported elsewhere, but it does not appear likely that this result will be generally applicable for

swabbing treatments. The sodium and triethanolamine salts of 2,4,5-T in water and the ester in power kerosene have given about a 90 per cent. kill, and the ester in water an 85 per cent. kill. The combination of 2,4-D and 2,4,5-T esters in water has given a very poor kill, but in power kerosene has given about a 90 per cent. kill. Power kerosene alone has given a 40 per cent. kill.

The concentration used in all cases was 1.0 per cent. acid equivalent. This is obtained as follows: If the concentrate purchased contains 40 per cent. active ingredient, one part to 40 parts of water or kerosene gives a 1.0 per cent. solution. If the concentrate has 36 per cent. active ingredient, one part to 36 parts gives a 1.0 per cent. solution and so on.

It is probable that poisoning with 2,4,5-T will be more successful if carried out during the middle to late summer period, although this has not been definitely established.

The main eucalypts tested have been bloodwood (*E. intermedia*) and spotted gum (*E. maculata*); small scale tests have been made on blue gum (*E. tereticornis*), ironbark (*E. drepanophylla*), and grey gum. It appears that all these eucalypts are susceptible to 2,4,5-T when it is applied in swabbing treatments.

A few small tests carried out on hickory wattle (*Acacia aulacocarpa*) and forest oak (*Casuarina torulosa*) suggest that these species are also highly susceptible to 2,4,5-T in kerosene. Small tests on brigalow (*Acacia harpophylla*) and mahogany (*Tristania suaveolens*) gave promising results.

It has been found that hickory wattle (*Acacia aulacocarpa*) and green wattle (*Acacia mollissima*) can be killed also by spraying the bark from ground level to about two feet up the stem with 2,4,5-T in kerosene, without cutting the stems in any way. This method leaves the trees still standing but in some situations may be useful. It has been of no use on spotted gum, grey gum, ironbark or bloodwood.

Acknowledgment.

It is desired to express thanks to Mr. E. K. Beattie, of Wolvi, for much help in carrying out the experiments.

Precautions in Using Dinitro Weedkillers.

AMONG the selective weedkillers in use in Queensland is a material which has as its active constituent sodium dinitro-ortho-cresylate. This is used here mainly for the chemical weeding of onion crops, but in England and America is quite extensively employed in cereals as well as onions and various other crops.

Several deaths and numerous cases of non-fatal poisoning by dinitro compounds have occurred overseas, mainly among sprayers working in grain crops in warm weather. The purpose of this note is to draw the attention of farmers to the hazards of using dinitro compounds without adequate precautions.

Some people are more susceptible than others to poisoning by dinitros. The more contact a man has with the material, the greater the risk he runs. The average onion grower, with only a comparatively

small area to treat and using a dinitro spray perhaps for only a short period each year, would not be exposed to nearly the same danger as a team of men engaged on contract spraying. Nevertheless, the danger of poisoning is there and should be guarded against.

How Poisoning May Occur.

Dinitro compounds may cause poisoning by being swallowed, by being breathed in, or by being absorbed through the skin. No great amount is likely to be swallowed, but both inhalation and skin absorption can happen quite easily. Skin absorption probably presents the greatest risk of all, because dinitros do not set up an irritation when they are spilt on the skin and a fatal dose could easily be absorbed through the pores unnoticed. Incidentally, the amount of yellow skin discolouration is no indication of how much the skin has absorbed.

Precautions to be Taken.

Anyone handling dinitro compounds, even occasionally, is advised by the Director-General of Health and Medical Services to observe the following precautionary measures:—

1. Beware of concentrated solutions. If any of the concentrate splashes on to the skin, wash it off immediately with soap and water. If it soaks through the clothes, change them at once. The greatest danger lies in absorbing the concentrate through the skin.
2. Avoid contamination with the spraying solution even though it is dilute enough to be comparatively harmless. Repeated contact may cause poisoning.
 - (a) Don't use leaking apparatus or overfill the knapsack spray so that the solution spills on the clothes and skin.
 - (b) Whenever possible, spray in calm periods when it is possible to avoid the mist while spraying.
 - (c) Do not adjust the nozzles while the spray is running, otherwise quite a deal of spray may be inhaled.
3. Take care with the residue which dries out on the spraying apparatus—it can be dangerous.

Symptoms.

The symptoms of dinitro poisoning are easily recognised. Excessive thirst, excessive sweating, and progressive loss of weight are the danger signs. If any or all of these symptoms are noticed, stop using the spray and see a doctor immediately.

ADDITIONS TO TECHNICAL STAFF.

Seven men who recently graduated in veterinary science at the University of Queensland have joined the Department's Division of Animal Industry. Five of the new appointees held Departmental scholarships.

The Minister for Agriculture and Stock (Hon. H. H. Collins) said that these appointments will enable the ever-increasing demand from the livestock industries for technical services to producers to be more fully met. Those appointed as veterinary officers will work in the field and on research problems, while the others will serve as husbandry officers attached to the Sheep and Wool and Cattle Husbandry Branches of the Division.



How to Produce Choice Cream.

E. B. RICE, Director of Dairying.

DAIRY buildings and equipment of a reasonable standard are conducive to efficiency in the routine of a dairy farm, but much can be achieved even with limited facilities, provided every care is taken which skill and experience suggest. There are, however, two primary requirements for the production of cream of high quality—

- (1) An abundance of water at the dairy shed (Plate 106);
- (2) Adequate facilities for boiling water; a 12-gallon copper (or its equivalent) provides the minimum requirement.

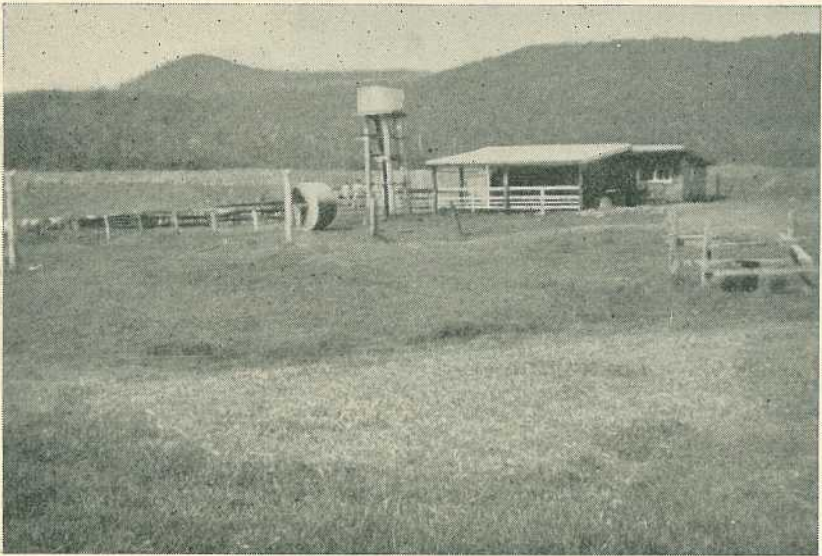

Plate 106.

Water for the Dairy Shed.—An adequate supply of water at the dairy premises is essential for clean cream production.

On many farms on which low quality cream is frequently produced these essentials are often lacking. They should be given priority over all other considerations by any producer who may only gradually be able to bring his premises into conformity with the Dairy Regulations.

Other important requirements for effective dairy shed hygiene are—

- (3) A wash-up trough.
- (4) A metal-piping draining rack for storage of utensils and cream cans.
- (5) A supply of suitable brushes, detergents (cleansing compounds, such as washing soda or soda ash for utensils to be washed by hand and caustic soda for washing milking machines), and a chlorine compound for rinsing utensils and cans just before re-use.

The rules of dairy hygiene set out below have been prepared with the object of assisting in the production of choice quality cream. By studying the rules and then by strictly amending any practices found to be at fault, any supplier of low-grade cream should be able to bring about a prompt improvement in quality to choice grade.

Rules of Dairy Hygiene.

1. All milking cows should be sound and healthy.
2. Freshly-calved cows' milk should not be separated until at least five days after calving.
3. Before milking begins, rinse with clean water, or a weak chlorine solution, all cream cans and utensils (including the milking machine, if used).



Plate 107.

A Concrete Holding Yard Facing the Bails is an Asset on a Dairy Farm.—Note the large shade trees in the outer yard, which provide ideal summer shade for cattle waiting to be milked.

4. Wash udders and teats with a cloth moistened in a weak chlorine solution. Keep enough cloths to enable each to be replaced as it becomes soiled.

5. Test the foremilk of each teat to observe if the milk is normal. Keep a separate small vessel for the foremilk, which, if sound, may be subsequently fed to pigs, or rejected. A piece of black cloth fixed over the strip-cup helps in detecting clots, presumptive evidence of udder trouble.

6. After milking, wash, scald, and hang udder cloths to dry in a dust-free place.

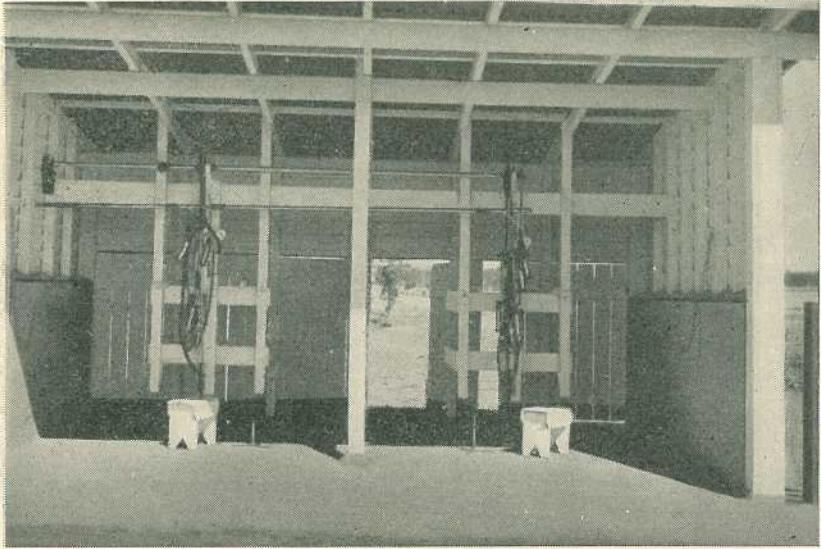

Plate 108.

Interior View of the Bails on a Well-kept Dairy Farm.—Note that the side walls are cemented and finished off with a steel trowel, and that the tops of the end walls are left slanting so that people will not put anything on them.

7. Wash the hands before and as often as necessary during milking. Provide soap, water and towels for this purpose. Practice dry milking. Do not "lubricate" the hands with milk.

8. The sterility of utensils is the most important single factor in dairy hygiene. Thoroughly clean and near-sterilize all utensils after use in the following way:—

- (a) Immediately after milking, first rinse utensils with plenty of cold water to remove all remnants of milk and cream.
- (b) Then wash utensils thoroughly (both inside and outside where necessary) with warm water in which washing soda or other cleaner has been dissolved. This makes the utensils physically clean.

- (c) Then steam the utensils or immerse them in boiling water. "Scalding," which is the usual final step on most farms, is only efficient if plenty of boiling water is used. The utensils should then be near-sterile.

(Note.—For a milking machine, steam is necessary for effective final sterilization. Likewise, in cleaning, at least one gallon of water per unit is required for the preliminary cold water rinse and the hot cleansing solution.)

- (d) Allow utensils to drain and dry in an inverted position on a metal draining rack situated in a dust-free atmosphere; if desired, the rack may be in a sunny position. Do not use a cloth to dry dairy utensils.

9. Use good quality brushes and not wash-up cloths for cleaning of dairy equipment. Wash the brushes daily after use.



Plate 109.

Well Laid Out Dairy Premises and Yards.—Note the well-kept lawns around the dairy, the suspended bails, and the pipe rack for holding and sunning dairy utensils.

10. In addition to the daily cleaning procedure, dismantle and thoroughly clean and sterilize the milking machine once every week.

11. Flush out and effectively steam at least once weekly the airline of the milking machine.

12. Immediately after separation, cool cream to as low a temperature as practicable and make every effort to keep it cool until despatched to factory.

13. The proper blending of cream from different milkings is important. Do not mix warm with cold cream until the animal heat has been removed.

14. Unless held at a low temperature in a refrigerator, stir cream with a metal stirrer from time to time while it is held on the farm.

15. Thoroughly cleanse all cream cans returned from the factory before again using them for cream.

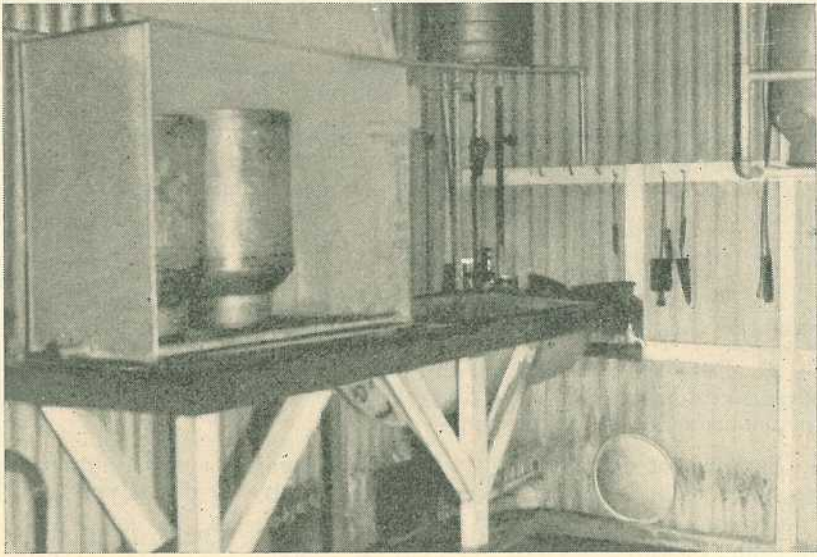

Plate 110.

A Farm Cream Can Sterilizer.—The sterilizer holds three 8-gallon cans at a time. Note that hot and cold water are laid on to the wash-up trough.

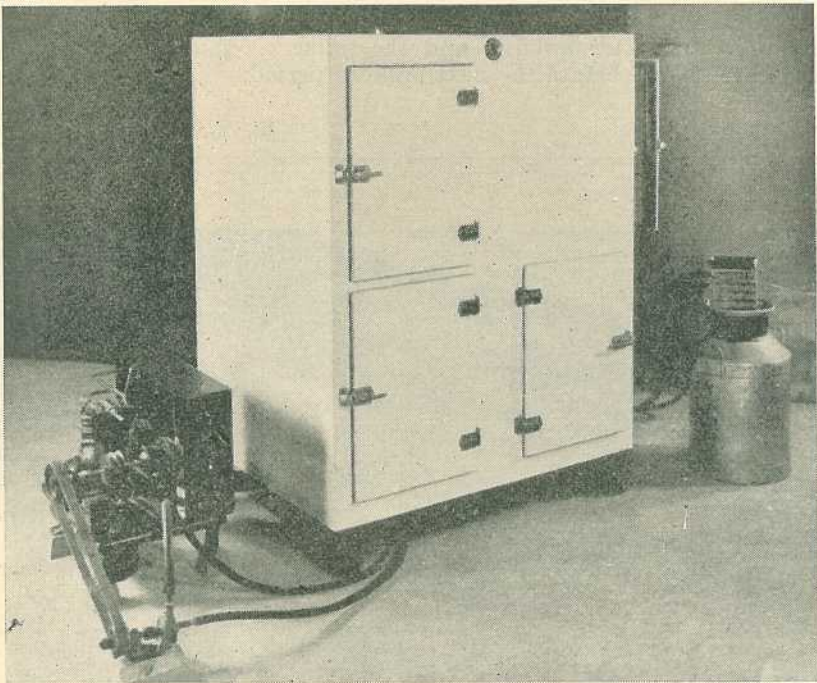

Plate 111.

A Farm Cream Refrigerator Unit.—Note the small cooler through which water is circulated to cool the cream as it enters the can. The cans of cooled cream are then held in the refrigerator cabinet.

16. Adjust the cream screw on the separator to give cream of a 40 to 44 test in summer, and at least a 36 test in winter.

17. Send cream to the factory as often as practicable. The objective in the summer should be daily delivery.

18. Maintain cream cans, all other utensils and equipment in good repair, and, when necessary, promptly make renewals or have the cans retinned. Renew milking machine rubberware as necessary.

19. Sweep and wash down the floor of the bails daily. Spreading lime on the floor is a good practice.

20. Remove manure from the cowyard daily and endeavour to abate the dust nuisance.

21. Keep the milking shed and dairy tidy. As required, repaint and limewash buildings. Use the dairy house exclusively for dairy produce and not as a general storeroom.

22. Protect dairy produce at all times against contamination from flies, dust, odoriferous substances, and exposure to direct sunlight.

23. Kindness in "breaking in" a heifer repays itself by the behaviour of the animal throughout its milking life. Do not tolerate noise or rough handling of animals in the milking shed. Nervous or fractious cows are detrimental to cleanly shed practices.

24. Do not "set" dogs on dairy stock.

25. If milk-tainting fodders, such as lucerne, are being used, they should be fed after milking and the milkers removed to pasture at least three hours before the next milking period.

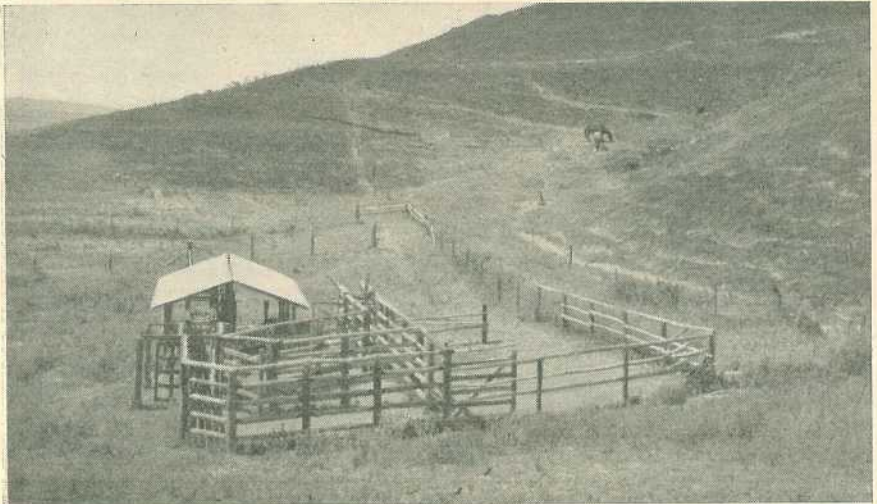

Weighbridge and Yards for Experimental Cattle at the Bureau of Tropical Agriculture, South Johnstone.



The Sheep Blowfly Problem in Queensland.

1. Blowflies and Their Breeding Habits.
2. Blowflies in Relation to Their Environment.

G. R. MOULE, Director of Sheep Husbandry.

Introduction.

NEARLY fifty years have elapsed since blowflies affecting sheep first appeared in Queensland, and during that time they have caused serious losses to the sheep industry. These losses must be measured in terms of dead sheep, lowered lambmarking percentages, lower cuts per head, lower wool prices, the cost of dressings and dips, higher labour charges, and increased worry to wool growers. It is not surprising therefore that a considerable amount of research work has been undertaken all over Australia in an effort to control blowfly strike in sheep.

The word "control" is often used in different ways, particularly in relation to blowfly strike. The complete control of blowflies—that is, the absolute prevention of fly strike—would be extremely difficult to attain, and even if it were possible it may be far too expensive to contemplate. On the other hand it is possible, without the expenditure of a large amount of money and time, to reduce fly strike to such a low incidence that it ceases to be of major importance to the industry or to individual property owners.

At least some of the methods which can be used by the industry to control blowfly strike are fairly well known by wool growers. However, it is surprising that so many pastoralists do not appreciate that the most satisfactory results will be obtained by working to a definite plan, which aims at anticipating the times when blowflies will be active, and at taking reasonable precautionary measures to prevent strike among flocks.

These articles aim at acquainting wool growers in Queensland with the nature and extent of the blowfly problem and with the background to the control measures which might be employed.

1. Blowflies and Their Breeding Habits.

THE BLOWFLIES CONCERNED IN STRIKE.

There is a large number of different kinds of blowflies, but not every species attacks sheep. Most blowflies are attracted by the odours of putrefaction and for that reason they are to be found on or about carcasses.

There are about a dozen different kinds of blowflies which attack sheep in Australia, and these have been classified depending upon their ability to initiate a fresh strike or to invade a strike which has already become established. The flies which are capable of initiating strike are referred to as primary flies, and they include the common green blowfly (*Lucilia cuprina*) and the brown blowflies (*Calliphora stygia* and *Calliphora augur*).

The flies whose maggots invade a strike which is already established are called secondary flies, and amongst these are the secondary green blowfly (*Chrysomya rufifacies*) and the steel-blue blowfly (*Chrysomya micropogon*).

Some flies are attracted to wounds or carcasses only after the maggots of the secondary flies have become established. These are known as tertiary flies, but they are not of very great importance in Queensland.

The Primary Blowflies.

The common green blowfly, which is the most important primary fly in Queensland, is medium sized and about five-sixteenths of an inch long. It is a bright metallic green in colour, and sometimes has a golden or bronzy sheen. The back of the chest is covered with strong black bristles and some short fine bristly hairs occur on the abdomen, which is short and tapering. The legs are black except for the thighs of the front pair, which are bright green. The maggots which hatch from the eggs laid by this fly are creamy coloured, though some have a faint pinkish tinge. Their bodies are perfectly smooth.

The brown blowflies are commonly referred to as the large brown blowfly and the small brown blowfly. The large brown blowfly (*Calliphora stygia*) is a very robust fly, measuring up to half an inch in length. It buzzes furiously and occurs commonly in houses in eastern Australia. Its eyes, abdomen, and legs are brown in colour; its thorax, which is slaty grey, carries large black bristles. Fine golden hairs occur on the under and upper side of the abdomen.

The small brown blowfly (*Calliphora augur*) also occurs in houses in eastern Australia. It is smaller than the large brown blowfly. Its eyes and thorax are similar in colouring to those of the large brown fly, but the abdomen, which is yellowish brown, carries a dark steel-blue patch in the centre.

The Secondary Blowflies.

The three most important secondary blowflies are the secondary green blowfly or large hairy maggot blowfly (*Chrysomya rufifacies*), the small green blowfly or small hairy maggot blowfly (*Microcalliphora varipes*) and the steel-blue blowfly (*Chrysomya micropogon*).

The secondary green blowfly is often mistaken for the primary green blowfly, as they are about the same size and of similar colour. However, the secondary green fly has a bluish tinge at the base of the abdomen and on its underside, and dark bands cross the abdomen at the junction of the segments.

The maggots which hatch from the eggs laid by this fly are well known as "hairy maggots." They are large and vigorous, brownish grey in colour, and furnished with a number of fleshy processes which differentiate them easily from the smooth maggots of the primary flies.

The small green blowfly is quite similar in colouring to other green flies, but it is much smaller, being only about half the size of the other blowflies which commonly attack sheep. Its maggot is also rough like that of the large hairy maggot blowfly, but it is somewhat smaller and pale brown in colour.

The steel-blue blowfly is a broad robust fly, slightly less than half an inch in length. It is a dark steel-blue colour, though it has a tinge of green when alive. Unlike those of the other secondary flies, its maggots are smooth and cream coloured.

THE LIFE CYCLE OF BLOWFLIES.

All blowflies pass through four distinct stages—the egg, the maggot, the pupa, and the adult fly. Of these the second or maggot stage is most important to the sheep man, because the maggots parasitise sheep. The maggot stage is also of particular importance in the development of blowflies. Insufficient nourishment in this stage will result either in the death of the maggots or, if they survive, in the production of undersized adult flies.

The eggs of the different species of blowflies resemble one another and it is extremely difficult to differentiate them. They are creamy white in colour and are shaped somewhat like a banana. They are laid either singly or in clusters, and adhere by means of a sticky solution.

Except in very cold weather, blowfly eggs hatch in from one to two days. The average time of hatching for the green blowfly's eggs is twenty-four hours. The maggots which hatch from the eggs are of two distinct types and are commonly referred to as being either smooth or hairy. All the blowflies affecting sheep in Queensland have smooth maggots except the secondary green blowflies. The maggots are elongate grubs, for the most part cylindrical in shape, but they taper markedly towards the head end. The mouth is on the underside of the head, and the jaws can be extruded through it, in the form of two parallel black hooks.

The fully fed hairy maggot of the larger secondary green fly is slightly larger than the smooth maggot, and the effect of hairiness is produced by a number of fleshy processes, which bear clusters of minute spines at their tips. The mouth hooks are very strongly formed, stout, and sharply pointed, and used in attacks on other maggots.

The maggots of both primary and secondary flies pass through quite well defined stages before they become fully fed. The important thing to remember is that the first and second stages are passed quickly, usually within a day or so of hatching, and once a maggot has passed into its third stage of development it may be capable of completing its life cycle.

When feeding, primary maggots burrow their way into their food with their heads, tearing the flesh with their mouth hooks. Most of the food appears to be taken in liquid form, though very fine particles of solid matter may also be swallowed.

The large hairy maggot feeds both on carrion and on living smooth maggots. It should be regarded as one of the most important enemies of all primary maggots, as it devours smooth maggots and because of its superior strength usually takes heavy toll of the smooth maggots established in any strike.

It is essential to remember that the large hairy maggots cannot, under normal circumstances, obtain a footing on living sheep unless strike has already been initiated by primary smooth maggots.

When the maggots are fully fed they commence to wander, apparently in search of a suitable place to pupate. A number of factors influence the duration of the wandering stage, and these include temperature and humidity. If the sheep does not succumb as the result of being struck, the maggots drop to the ground, where they may continue wandering until they find some spot suitable for pupation. Even in dry weather some maggots have been observed to travel a horizontal distance of 10 feet through fairly compact soil on the bank of a creek.

Pupation, which is the next stage in the blowfly's life cycle, can be regarded as a period of rest, during which definite developmental changes take place. As pupation commences the maggot's skin, which becomes thick and tough, forms a protective coat. This finally assumes the shape of a barrel, and becomes dark and hard. The delicate tissues within are gradually broken down and reformed into the adult fly.

When the adult fly is ready to emerge it sheds its delicate pupal skin, and gradually forces the top of its protective shell. The fly then works its way out into the soil and eventually reaches the surface. Flies have been observed to have worked their way up from pupae buried $3\frac{1}{2}$ feet below the surface.

When the newly emerged fly appears on the surface of the soil it runs about until its wings are fully expanded and its body is fully coloured and hard. It then flies off in search of food.

THE POWER OF INCREASE OF BLOWFLIES.

The ability of blowflies to increase in numbers depends upon the rapidity with which the life cycle is completed and also upon the average number of progeny produced.

The Duration of the Life Cycle.

The time taken to develop from the egg to the adult fly depends chiefly upon the weather. Development is more rapid in warm, moist weather than it is in cold. The steel-blue blowfly, which is a tropical and sub-tropical species, is the quickest to develop of any of the blowflies so far studied. It averages seven days from the laying of the egg to the emergence of the adult fly. It takes about another three days for the female fly to become sexually mature, making a total of ten days from egg to egg. The female fly lives for a month or more and is capable of depositing eggs over most of that period.

The Number of Progeny.

The largest number of adult progeny obtained from a single blowfly under insectary conditions was over 2,000. The average number has been well over 1,000. Allowing that one-half of the flies produced will be females, this means a 500-fold increase in each generation. Assuming 1,000 blowflies weigh an ounce, a pair (male and female) of the most prolific steel-blue blowflies could produce enough offspring in eleven months to equal the weight of the whole world!

It is very difficult to eradicate parasites which have such a tremendous power of increase, unless steps can be taken to destroy the flies' breeding ground and this is one of the most important objects in modern blowfly control measures.

2. Blowflies in Relation to their Environment.

Two environments must be considered in studying the effects of environment upon the blowflies affecting sheep. They are :—

- (1) The external environment to which the adult flies are exposed.
- (2) The environment available to the blowfly maggots.

A good deal of work has been undertaken in studying both of these environments and because of their relative importance each one is discussed in this section.

THE GEOGRAPHICAL AND SEASONAL DISTRIBUTION OF FLIES.

The distribution of the primary green blowflies (*Lucilia*) strongly suggests that they were imported into Australia. *Lucilia cuprina*, which is chiefly responsible for primary strike of sheep in Queensland, is essentially an inland species. It occurs at Julia Creek in the north-west of the State and extends as far south as Albury and adjacent districts in northern Victoria.

The numbers of primary green blowflies which are present vary with the seasonal conditions. In warm climates, such as those in Queensland, there are two well defined periods when they are prevalent :—

- (1) During the autumn months of April and May.
- (2) During the spring and early summer months of August, September, October and November.

The secondary green blowflies are both native Australian species and they have a very wide distribution. They are both essentially summer flies. In southern Queensland they are prevalent in the spring and autumn, while in tropical Queensland they can be found practically all the year round.

The steel-blue fly is also a tropical and sub-tropical species and it occurs practically throughout the year.

The brown blowflies are the outstanding members of the blowfly family throughout southern Australia. In warmer sub-tropical climates, however, they become purely a winter species.

Temperature is the most important single climatic factor affecting the activity and fertility of adult flies. The common primary green blowfly is most active in air temperatures of 80 deg. F. when exposed to temperatures which are kept constant. If air temperatures are rising they are most active at or about 68 deg. F. Other species—for example, the large brown blowfly—are more active at lower temperatures, and are not as active as the primary green blowfly at higher temperatures. Temperatures as low as 60 deg. F. depress the rate at which female flies lay their eggs.

The long hot summers experienced in north-western Queensland greatly reduce blowfly activity in that area. It is not uncommon for maximum temperatures to exceed 100 deg. F. in April, and hot spells sometimes extend to May. They commence again in October. This tends to restrict blowfly activity to the early winter and early spring months. In the southern part of the State where conditions are more equable the usual autumn and spring waves are easily recognised.

Wide ranges of relative humidity, from 15 per cent. to 100 per cent., do not produce any observable effects on the adult flies. Most of the species that occur in Australia are most active in bright sunlight, but there is evidence that the common green blowfly is active in dull as well as in sunny weather. This is important, as it is in showery, sultry weather that sheep are most susceptible to attack.

Cold weather also decreases blowfly activity. This is of particular importance in the Stanthorpe, Mitchell and Tambo districts, which usually experience colder winter conditions than other parts of the sheep country. It is usually safe to say that in Queensland frosty weather reduces fly strike, and the cold dry southerly winds which blow sometimes in winter over the open Mitchell grass downs country usually curtail blowfly activity very quickly.

THE ENVIRONMENT AVAILABLE TO THE BLOWFLY MAGGOTS.

Most people know that blowflies breed in carrion. While this generalisation is true for many varieties of blowfly it does not apply fully to those varieties which parasitize sheep.

Carrion passes through definite stages of decomposition, and each is occupied by the maggots of particular species of flies. The primary green flies and the brown flies come first, and after their maggots are established they are followed by secondary flies.

In the earliest stages there is ample room for the young primary maggots, but as they grow intense competition occurs for the available food and space.

When the vigorous, rapidly growing, voracious hairy maggots of the secondary flies arrive, competition becomes more intense. As the secondary maggots devour the smooth primaries they suffer badly from these attacks and the lack of space and food. Half a sheep carcase,

which was protected from further attack after the primary flies had laid their eggs, produced 14,300 primary flies. In the other half of the carcase the secondary flies were allowed to strike on top of the primaries. Only 87 primary flies hatched.

There is an assortment of beetles and wasps which invade the carcase in its complete stages of decomposition and parasitize blowfly maggots and pupae.

Climate also affects the development of the maggots in carrion. In hot weather the hairy maggots grow very rapidly and the first stage of decomposition of a carcase may last only 24 hours. This increases the competition which the primary maggots must meet, and few survive. In cool weather, however, the brown fly's maggots grow better than the hairy maggots and in addition decomposition is prolonged. This gives the primary maggots a chance to complete their development and devour most of the carcase before they are displaced.

The realisation that so few primary flies are produced from a carcase led to a comparison between the live sheep and carrion as a breeding ground for sheep blowflies.

Sheep do present a special environment for blowfly maggots, and as a result they exert a profound influence on fly populations. The following points summarise the way in which this occurs :—

- (1) The sheep is particularly attractive to the common green blowfly and consequently the maggots of this species are dominant as primaries in strikes, even in districts where adult flies of the species constitute as little as 1 per cent. of blowfly population.
- (2) The susceptible sheep provide shelter favourable to maggots, as well as optimum temperature and moisture conditions. However, they do not provide quite as much food.
- (3) The hairy maggots only attack a portion of the struck sheep, and even on these do not displace the primaries as effectively as they do on carrion.
- (4) The maggots are not so crowded on the large sheep as they are on carrion.
- (5) Maggots on struck sheep are free from other parasites which attack them.

This results in a higher survival of primary green fly maggots on struck sheep than on carrion. As many as 1,700 adult green blowflies were bred from an extensive natural breech strike, whereas seldom more than 100 emerge from a carcase.

The practical applications of this information are clear :—

- (1) It is futile to prevent flies breeding in dead animals, when crutchings from struck sheep are left about so that maggots can complete their development.
- (2) Fly waves build up as the result of flies breeding in struck sheep. In all control measures it is essential to prevent a high incidence of strike developing amongst the sheep in any flock. This leads to rapid increases in fly populations.



Beef Cattle Production on Some of the Gulf Watersheds.

J. C. J. MAUNDER.

[Continued from page 60 of the January issue.]

STOCK ROUTES.

The main arterial stock routes that carry the regular store movements from the Gilbert and Mitchell country were investigated to determine (a) the type of country through which cattle travel, (b) existing water facilities, (c) numbers of cattle using the routes, (d) origin and destination of movements, and (e) watering facilities required to improve the routes. Some of this information was obtained by discussions with owners, managers, drovers and stockmen, some by personal observation; most of it was collected by the District Inspector of Stock (Mr. N. C. Copeman).

(1) Gilbert River Stock Route.

The route follows the river frontage country of the Gilbert and Einasleigh, through Miranda Downs, Strathmore, Abingdon Downs to Dagworth, Talaroo, thence through Einasleigh, Carpentaria Downs, Lyndhurst, and on to the fattening country of the Burdekin basin.

As far as Dagworth, the country is flat, devoid of stone and usually carries a good body of feed from April to the end of September. Sometimes a shortage occurs in November and December, especially when fires have wiped out a lot of dry feed and where storms have been "patchy." There is some stone in the vicinity of Talaroo on the Talaroo-Einasleigh stage, but generally speaking the whole route is good.

This route not only carries all the cattle from the Gilbert area, but is also used by cattle from Magoura and Croydon and by some small Georgetown mobs. Approximately 20,000 head per annum would use the main Gilbert River via Abingdon Downs to Einasleigh route.

The existing natural water supplies are usually adequate for normal travelling seasons and consist of large permanent "holes" in the Gilbert and Einasleigh Rivers and "off river" lagoons. The weakest part of the route is from Talaroo to Einasleigh. There are no artificial watering facilities on any part of the route.

The gazetted stock route through Forest Home and Georgetown and over the Newcastle Range into Einasleigh, known as "Hell's Gate Road," is practically unused, being short of feed, almost devoid of water, and traversing rough, steep and stony country. Even if water were to be made on this route, it is doubtful if it would be used to any extent.

(2) Mitchell River and Van Rook Connecting Routes.

The main Mitchell route follows the frontage country of the Mitchell and passes through Dunbar, Highbury, Gamboola, Walsh Telegraph Station and Wrotham Park, thence through Rookwood to Mungana, Chillagoe and Alma-den. Many cattle are trucked at Mungana, while most of the remainder walk through Chillagoe and Alma-den to Fossilbrook, Mount Surprise, Rosella Plains and Spring Creek to fattening properties in the Mount Surprise and Burdekin basin districts.

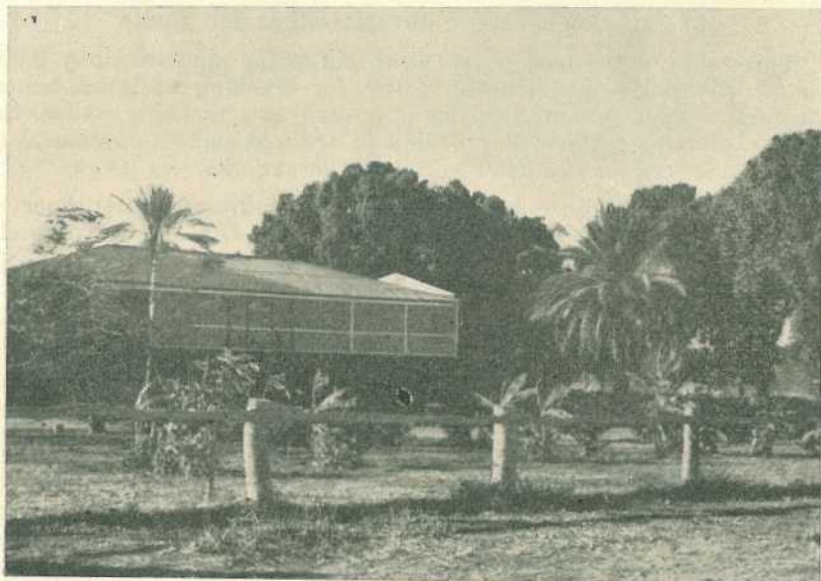

Plate 112.

A Typical Homestead in the Gulf Area.

The route connecting the Mitchell and Gilbert routes passes through Dunbar and Van Rook and up Echo Creek to join the Gilbert route near Minnies Lagoon (Strathmore) on the Einasleigh.

The main Mitchell route as far as Nolan Creek (Wrotham Park) carries a good body of feed and traverses flat country free of stone. Storms and fires affect the feed position, as for the Gilbert. From Nolan Creek the going becomes slightly rougher with more stone, especially through Mungana, Chillagoe, Alma-den and on to Fossilbrook. However, the route, even over these stoniest sections, cannot be regarded as difficult. Over this section feed is not so good as through the Mitchell frontage country.

The connecting route, Dunbar-Van Rook, is through flat forest country which provides easy travelling with ample feed of low nutritive value. There is no stone.

The main Mitchell route carries cattle from the Gulf and western and lower Peninsula areas for trucking at Mungana or fattening on properties in the Mount Surprise and Burdekin basin districts. The numbers are approximately 18,000 per annum; 9,000-10,000 of these are trucked at Mungana.

The connecting route carries Dunbar cattle (including purchases from the Mission) in those seasons when they do not use the main Mitchell route, and is therefore only an alternative one. The numbers average approximately 2,000-4,000 head per annum.

The connecting route, and the main Mitchell route as far as the Walsh Telegraph office, are adequately watered, with permanent "holes" in the river and permanent "off-river" lagoons. The main route from the Walsh Telegraph Station onwards is not well watered. There are no artificial watering facilities on either route.

(3) Einasleigh-Mount Surprise-Alma-den Route.

This route in the past provided an outlet for approximately 2,000 head of Einasleigh and Kidston cattle for trucking at Alma-den or Tumoulin. When Mount Surprise is opened as a trucking centre, the majority of these cattle will probably be trucked there for removal to Mareeba saleyards or slaughter yards and meatworks.

This route provides reasonable travelling conditions but is reported to require a permanent watering facility at Sandy Creek, approximately half-way between where it leaves the Einasleigh river and Quartz Hill, where there is permanent water in Elizabeth Creek.

In the past, a yearly total of approximately 4,000 head of cattle from the Kidston, Einasleigh, Georgetown and Mount Surprise areas used this route for trucking at Alma-den to meatworks or coastal fattening properties, but with the opening of the Mount Surprise-Alma-den line for cattle trains practically all these cattle would be trucked at Mount Surprise and this route should then only be used by approximately 2,000 head from Strathgordon and Strathburn, travelling to Strathfield, approximately 500 head from Mount Mulgrave, travelling to Mount Surprise Station, and approximately 2,500 head from Dunbar which at times travel this route via Mount Surprise, Rosella and Spring Creek to the Valley of Lagoons stations. It is also considered that some of these cattle may be trucked from Mungana via Alma-den to Mount Surprise, as this route is reported to be very stony in places and causes considerable lameness in cattle.

(4) Gilbert River-Georgetown-Talaroo Route.

This route provides reasonably good travelling conditions for the removal of the majority of cattle from the Georgetown and Gilbert River areas above Forest Home to their normal markets, with the exception of a bad stony and steep stage over the Newcastle Range which, according to experienced drovers, can be avoided to a great extent by diverting from the gazetted route on top of the Newcastle Range and going north to the Old Shamrock Pad, thence down the range and north-east to Talaroo.

From the above, it will be seen that stock routes are fairly good, and it is not until cattle leave the eastern fringe of the Gulf area that travelling conditions and water supplies are a problem.

DISEASE CONTROL PROBLEMS.

Cattle ticks and buffalo fly are factors limiting production, while mineral deficiencies, contagious pleuro-pneumonia, tick fever and mortalities in calves are all of some consequence. There is some trouble with poison plants, and horses are troubled with Kimberley and/or Birdsville disease and worm infestations.

Cattle Ticks and Tick Fever.

At the time of the visit (September, 1949), cattle ticks were bad on the Mitchell country from the Walsh to about 100 miles down the Mitchell. From there to the coast, the tick population gradually decreased, and in the coastal country infestations were very light.

It is significant that there are fewer dips in the coastal country than further inland; furthermore, managers there do not appear to be so concerned about tick control as managers of places further up the rivers.



Plate 113.

A Strategic Dip at Minnies Lagoon Charged with DDT.

Beyond this coastal strip, there is no doubt that cattle tick control is one of the big problems of the area. Yards and dips are insufficient to handle the large herds dispersed over a wide area of unfenced country. Cattle are never mustered solely for dipping purposes and tick control is effected simply by putting cattle through the dip when they are yarded in the course of ordinary mustering. This means that cattle are probably dipped only twice a year and at most three times. With arsenical dippings, it will be appreciated that this is quite inadequate.

Tick fever does not occur in the permanently infested areas, but there is a considerable amount of marginal country around Croydon, the Gregory Range and the Georgetown district. Cattle from those areas have to travel through ticky country to their outlets and tick fever is fairly common in travelling mobs from these districts. Protective

inoculation is sometimes practised and attempts are being made to prevent outbreaks by the use of DDT dipping. Some cases of tick fever have also occurred from time to time in cattle from the coastal strip.

There is no doubt that the control of ticks and tick fever is a difficult problem, especially under the conditions of herd management practised. The rational use of inoculation and dipping in DDT, depending on circumstances pertaining at different places, at least provides two possible ways of dealing with the problem. How and when to apply them, and which to select, can only be decided on the spot.

The use of breeds of cattle resistant to cattle tick and buffalo fly would go a long way towards solving the problem of these two pests.

Buffalo Fly.

Buffalo fly probably does more to restrict growth and production than is generally realised. Although the cattle bred in the area appear to have developed some tolerance, bulls generally are more affected and introduced bulls are unable to work at full capacity owing to buffalo fly worry. Horses are troubled a lot and would work better if they were not irritated by the fly.

Although most stations realise the value of DDT for buffalo fly control, it is extremely difficult to apply control measures under their conditions of management. Some attempts are being made to alleviate the trouble in horses by spraying them in the mustering camps.

Contagious Pleuro-pneumonia.

The area has a bad name for pleuro-pneumonia and has long been regarded as a reservoir of infection from which the disease is spread throughout the State by means of stores purchased from the Gulf and dispersed throughout fattening areas.

No doubt there is some pleuro, but it may not be nearly as bad as imagined. The incidence is certainly lower here than in the cattle country of the Gregory, Leichhardt, Flinders and Saxby. Bullocks are usually vaccinated prior to going on the road, and there are few reports of outbreaks of pleuro amongst travelling mobs from the area. Any holding on which pleuro is known to exist would be well advised to adopt a routine policy of vaccination of yearlings, with a second vaccination before going on the road.

Malnutrition.

The fact that the pastures decrease in nutritive value from July to November, by which time they have very little value, is the biggest single factor limiting production in the area. Calves that are dropped during the worst of this period have a struggle to survive owing to the fact that their mothers can produce little or no milk on the poor type of feed available. As a result, losses may be quite heavy, especially with male calves that suffer the additional setback of castration. It appears that bone chewing is present throughout the area, as would be expected in country of apparently low soil fertility and fairly high rainfall. Soil phosphate values of samples taken at various places are given in Table 2.

No attempt is made to supply mineral supplements, and it is impossible to suggest a practicable and economical method of doing so. Salt-bonemeal mixtures could be put out in troughs around the permanent watering places, but there would be no way of ensuring that the

cattle consumed sufficient but not excessive quantities. Wastage of material would be high, and as freight charges would make the supplements very expensive, it is probable that attempts to feed them would prove to be uneconomical. However, there is little doubt that bonemeal feeding, if it could be practised, and provided the economics were sound, would produce worthwhile results. There is no evidence of botulism.

TABLE 2.
PHOSPHATE CONTENT OF SOILS.

Area.	Soil Type.	Phosphate (p.p.m. P_2O_5).	Remarks.
1. Mt. Surprise	Black soil plain	121	On alluvial soils, lucerne, onions and cereal crops are grown successfully
	Brown soil	496	Brown soil is representative of the bulk of the holding which is on the edge of the basalt country and fattens good bullocks
	Alluvial wash	764	
2. Einasleigh	Alluvial ..	250	Adjoins No. 1 holding—lucerne is grown on this alluvial, but does not look as well as No. 1
3. Einasleigh	" Off river "	43	Sample taken west of Einasleigh—the change from good to inferior country is rapid, as indicated by areas 1, 2 and 3
4. Gilbert River	Alluvial ..	50	The alluvial is typical of frontage; " off river" is forest of slightly better appearance than much of the forest country of the area
	" Off river "	43	
5. Van Rook	Bauhinia plain	107	Sample taken from a bauhinia plain between the Gilbert and Middle Creek. It carried a good body of grasses and was the best looking country seen in the Gilbert-Mitchell area
6. Staaten	Alluvial ..	25	This is the poor country of the Staaten and Red River, where true frontage is almost absent; gutta percha and tea-tree forest dominate the picture
	" Off river "	19	
7. Mitchell	Alluvial ..	41	The frontage looks reasonably good and carries most of the cattle. The forest (" off river ") is very poor in appearance
	" Off river "	28	

Miscellaneous Diseases.

It is unlikely that any considerable losses occur in cattle due to any disease conditions other than those previously mentioned. Some mortalities do occur in travelling stock, but generally speaking, the country appears to be reasonably free of poison plants.

Horses seem to do quite well, but it is possible that they carry a fair worm burden and would benefit from routine phenothiazine treatments. Reports of managers suggest that fairly heavy losses occur from so-called "Gilbert River disease," which is probably identical with Kimberley horse disease. There is evidence to suggest that the condition occurs in some areas where there is practically no whitewood, and does not occur in other areas where whitewood is plentiful.

TRANSPORT AND COMMUNICATIONS.

Being a remote area, it cannot be expected that transport and general communication would be very good, but the advent of aerial services has greatly improved conditions.

Some supplies come from Cairns by rail to Forsayth, thence by the Forsayth-Croydon road transport. Another route is by ship to Normanton, thence by road transport, or rail to Croydon, thence by road.

A weekly aerial service between Cairns and Normanton includes a circuit of the main stations, each of which has a landing strip authorised for use by the Department of Civil Aviation.

Stations are served by radio circuit and have the benefit of the very excellent service provided by the Cairns aerial ambulance. Two qualified nursing sisters are maintained at the hospital at Dunbar and one at the Mitchell River Mission.

During the wet season, most of the stations are inaccessible to road transport for a period of anything up to three months, but aerial services can usually be maintained.

GENERAL CONCLUSIONS.

One is somewhat diffident about reaching conclusions as a result of a comparatively short investigation, but some of the impressions received are set down here as a matter of interest.

(1) *Low Fertility of Forest Country.*—The bulk of the area is comprised of poor forest country, provided with ample water but capable of running only about two beasts to the square mile. It is subject to flooding; during the wet season it becomes very boggy, and the few cattle running there are forced on to frontage country and low sandy ridges.

(2) *Potentialities of Frontage Country.*—The carrying capacity of a holding is determined by the ratio of frontage to forest, the former carrying practically all the cattle. Though the frontages grow pastures which support a fairly heavy cattle population, it is doubtful whether the soils are physically and chemically suitable for the growth of supplementary fodder crops.

(3) *Potentialities of Coastal Country.*—In planned development of the area, the coastal strip extending about 20 to 30 miles inland should receive prior consideration. With its adequate rainfall, safe water supplies and apparently better soil types, it has the general appearance of country awaiting development. It is not, however, an undeveloped fertile area simply awaiting settlement, but rather gives the impression of country that requires scientific development to take full advantage of its potentialities and to make good its deficiencies.

(4) *Essentially Cattle Country.*—Any development of the country to increase its productivity should have as its objective the creation of an adequate reservoir in which large numbers of cattle can be bred to provide stores for fattening in the more favoured areas of North Queensland. That such a reservoir should be established and improved is of vital importance to the beef cattle industry.

(5) *Cattle Breeds and Environment.*—The environment of this tropical area, which subjects cattle to the hardships of cattle tick and buffalo fly and existence for five months of the year on grasses of low

nutritive value with practically no assistance from edible trees, shrubs or herbage, makes considerable demands on the adaptability of cattle. It demands much skill on the part of cattle breeders to develop a type suitable to the environment and makes equally great demands on the ingenuity of management to get the best out of such types.

The fact that no straight British breed has been accepted as the right type, cross-breeding in various combinations being adopted, together with the fact that stores reach the age of 3-4 years before being ready for movement to fattening areas, suggests that the breeders and managers are only holding their own in this battle against the environment.

The remoteness and nature of the area and the economics of the industry make it very difficult to alter the environment substantially, and therefore one of the fundamental requirements is to produce a beast than can more adequately cope with the environment. It is natural to turn to the Zebu-cross to produce this beast, and from personal observations and opinions of cattle men in the area, it is considered that this type of beast is likely to succeed.

An alternative to the Zebu hybrid is the development of a strain of British cattle that have been produced in the particular environment of this part.

In any plans for development of the country, high priority must be given to the development of a suitable breed to cope with the environment of poor, tropical country carrying coarse grasses of low nutritive value for six months of the year. Either of the above two methods is more likely to succeed than the policy of importing good bul's from vastly different environments.

(6) *Disease Control is Possible.*—It is considered that cattle tick and buffalo fly can be controlled effectively by the use of comparatively resistant types of cattle combined with dipping two or three times yearly in DDT. Even with the present breeds, this treatment would achieve considerable improvement.

Contagious pleuro-pneumonia can be controlled by vaccination, and nutritional disease is once more partly a matter of the beast for the environment.

(7) *Outlet for Cattle is Good.*—There is a good outlet for the stores bred in this area to fattening properties controlled by the same interests, or for sale to fatteners. Stock routes are reasonably good and do not restrict movements. With present store cattle values and with the prevailing pastoral company management policies, there is little likelihood that air-freighting of station-killed beef would be a practicable proposition.

ACKNOWLEDGMENTS.

In conclusion, the hospitality and helpful co-operation by all of those fine people of the beef cattle industry with whom contact was made are gratefully acknowledged.

The careful planning and organisation of Mr. N. C. Copeman, District Inspector of Stock, Cairns, who accompanied the writer on his visit, are also recorded with appreciation.

TUBERCULOSIS-FREE CATTLE HERDS

(AS AT 28th FEBRUARY, 1950.)

Breed.	Owner's Name and Address of Stud.
Aberdeen Angus ..	The Scottish Australian Company Ltd., Texas Station, Texas
A.I.S.	F. B. Sullivan, "Fermanagh," Pittsworth D. Sullivan, "Bantry" Stud, Rossvale, <i>via</i> Pittsworth W. Henschell, "Yarranvale," Yarranlea Con. O'Sullivan, "Navillus Stud," Greenmount H. V. Littleton, "Wongalea Stud," Hillview, Crow's Nest J. Phillips and Sons, "Sunny View," Kingaroy Sullivan Bros., "Valera" Stud, Pittsworth Reushle Bros., "Reubydale" Stud, Ravensbourne
Ayrshire	L. Holmaes, "Benbecula," Yarranlea J. N. Scott, "Auchen Eden," Camp Mountain
Friesian	C. H. Naumam, "Yarrabine Stud," Yarraman J. F. Dudley, "Pasadena," Maleny
Jersey	W. E. O. Meier, "Kingsford Stud," Rosevale, <i>via</i> Rosewood J. S. McCarthy, "Glen Erin Jersey Stud," Greenmount J. F. Lau, "Rosallen Jersey Stud," Goombungee G. Harley, Hopewell, Childers Toowoomba Mental Hospital, Willowburn Farm Home for Boys, Westbrook F. J. Cox and Sons, "Rosel" Stud, Crawford, Kingaroy Line R. J. Browne, Hill 60, Yangan P. J. L. Bygrave, "The Craigan Farm," Aspley A. Verrall and Sons, "Coleburn" Stud, Walloon

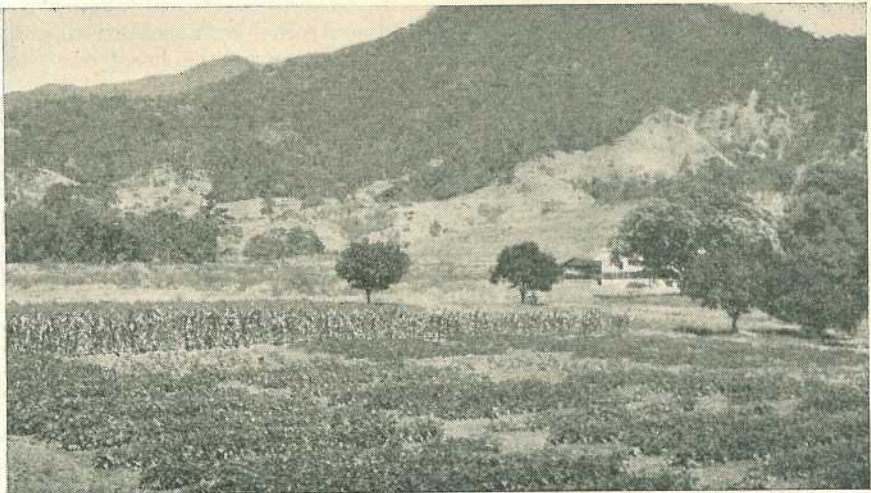

Trial Plots of Fruits and Vegetables at the Kamerunga Horticultural Station, near Cairns.

ASTRONOMICAL DATA FOR QUEENSLAND.

APRIL.

Supplied by W. J. NEWELL, Hon. Secretary of The Astronomical Society of Queensland.
TIMES OF SUNRISE AND SUNSET.

At Brisbane.			MINUTES LATER THAN BRISBANE AT OTHER PLACES.					
Day.	Rise.	Set.	Place.	Rise.	Set.	Place.	Rise.	Set.
	a.m.	p.m.						
1	5-57	5-47	Cairns ..	18	40	Longreach ..	30	40
6	6-00	5-41	Charleville ..	26	28	Quilpie ..	36	34
11	6-02	5-36	Cloncurry ..	42	58	Rockhampton ..	5	15
16	6-05	5-31	Cunnamulla ..	30	28	Roma ..	16	18
21	6-08	5-26	Dirranbandi ..	20	18	Townsville ..	16	34
26	6-10	5-21	Emerald ..	14	24	Winton ..	34	46
30	6-12	5-18	Hughenden ..	27	43	Warwick ..	5	3

TIMES OF MOONRISE AND MOONSET.

At Brisbane.			MINUTES LATER THAN BRISBANE (SOUTHERN DISTRICTS).								
Day.	Rise.	Set.	Charleville 27 ;		Cunnamulla 29 ;		Dirranbandi 19 ;				
			Quilpie 35 ;		Roma 17 ;		Warwick 4.				
			MINUTES LATER THAN BRISBANE (CENTRAL DISTRICTS).								
Day.	Rise.	Set.	Emerald.		Longreach.		Rockhampton.		Winton.		
			Rise.	Set.	Rise.	Set.	Rise.	Set.	Rise.	Set.	
1	a.m.	p.m.									
2	12-24	2-39	1	20	12	45	26	20	1	52	
3	1-30	3-19	6	18	22	33	38	9	13	38	
4	2-34	3-54	11	9	30	25	45	0	21	26	
5	3-35	4-25	16	12	28	27	43	2	19	30	
6	4-33	4-55	21	23	16	39	31	14	7	45	
7	5-30	5-25	26	30	9	46	23	21	0	54	
8	6-27	5-55	30	23	14	39	30	14	5	45	
9	7-23	6-27	MINUTES LATER THAN BRISBANE (NORTHERN DISTRICTS).								
10	8-21	7-03	Day.	Cairns.		Cloncurry.		Hughenden.		Townsville.	
11	9-19	7-44		Rise.	Set.	Rise.	Set.	Rise.	Set.	Rise.	Set.
12	10-15	8-29	1	29	12	45	26	20	1	44	6
13	11-10	9-18	3	24	15	41	30	16	6	35	17
14	12-01	10-12	5	19	19	36	35	10	10	25	25
15	1-28	11-08	7	15	24	30	40	6	15	17	34
16	2-05	12-06	9	12	28	27	43	2	19	9	42
17	2-39	1-04	11	9	30	25	45	0	21	4	46
18	3-11	2-03	13	9	30	25	45	0	21	3	46
19	3-43	3-02	15	11	28	25	43	0	19	7	41
20	4-15	4-02	17	14	35	29	41	4	17	15	37
21	4-48	5-04	19	19	21	34	38	10	12	23	29
22	5-23	6-10	21	23	16	39	31	14	7	33	19
23	6-11	7-19	23	28	12	44	27	19	2	42	9
24	7-03	8-31	25	30	9	46	23	21	1	46	3
25	8-02	9-42	27	30	9	45	24	20	0	44	4
26	9-08	10-49	29	25	13	42	28	16	2	36	11
27	10-16	11-47	30	23	14	39	30	14	5	32	16
28	11-23	p.m.									
29	..	1-19									
30	a.m.	1-55									
	12-28										

Phases of the Moon.—New Moon, April 6th, 8.52 p.m.; First Quarter, April 14th, 10.55 p.m.; Full Moon, April 22nd, 7.30 p.m.; Last Quarter, April 28th, 12.17 p.m.

On April 15th the Sun will rise and set 13 degrees north of true east and true west respectively, and on the 6th and 19th the Moon will rise and set approximately at true east and true west respectively.

Mercury.—An evening object at the beginning of the month, when in the constellation of Aries it will set 45 minutes after the Sun. On the 5th it will be 19 degrees east of the Sun and on the 25th will be in line with the Sun, after which it will pass into the morning sky. By the end of the month, still in the constellation of Aries, it will rise 35 minutes before the Sun.

Venus.—At the beginning of the month, in the constellation of Aries, will set 1 hour 36 minutes after the Sun and on the 9th near midnight the Moon will pass 4 degrees to the north. By the end of April, in the constellation of Taurus, will set 2 hours 13 minutes after the Sun.

Mars.—Now too close to the Sun for observation.

Jupiter.—At the end of the month, in the constellation of Pisces, may be seen low in the west during morning twilight, when it will rise 2 hours 24 minutes before the Sun.

Saturn.—In the constellation of Virgo; at the beginning of the month will rise about sunset and is thus favourably placed for observation during the whole night. By the end of April it will rise during the afternoon daylight and will set between 3 a.m. and 4.15 a.m.

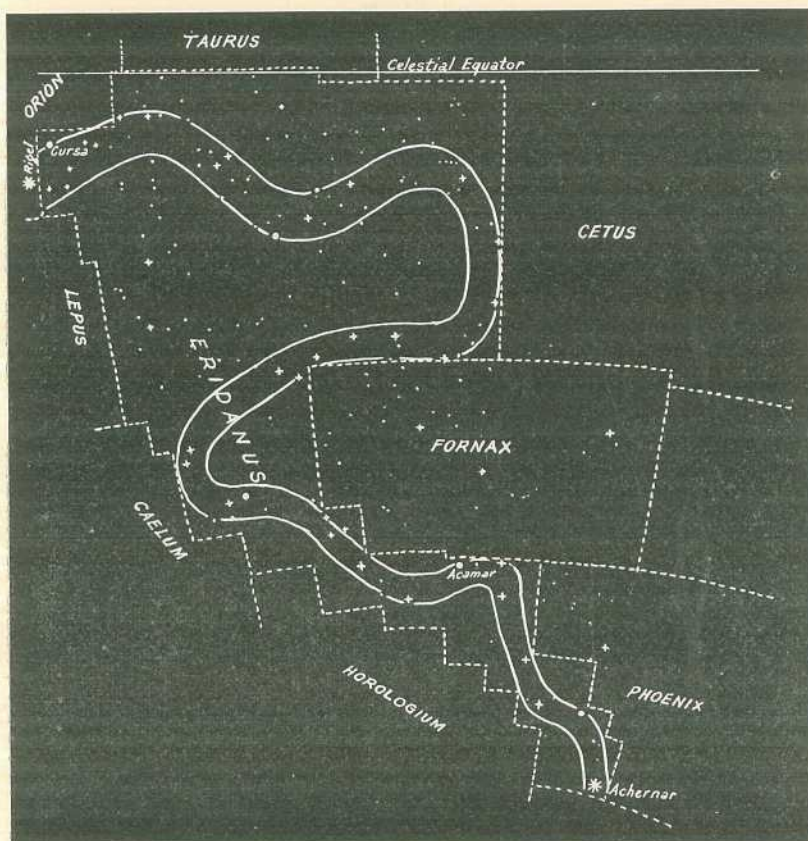

THE CONSTELLATIONS.

Phoenix.—A modern constellation adjoining Grus and Eridanus. It is not a very conspicuous group, containing only one star of second magnitude and two of third magnitude. The rest are of 4th or lower magnitude.

Sculptor.—Another inconspicuous modern group containing no star greater than 4th magnitude. It is important, however, for the fact that it contains the South Galactic Pole (the pole of the Milky Way).

Fornax (The Furnace).—Also a modern constellation, adjoining Sculptor, but does not contain any star greater than 4th magnitude.

Eridanus (The River Eridanus).—Eridanus is a Greek name for the River Po and this constellation is rather like a meandering river. It borders Orion, which straddles the equator on the north and straggles in a south-south-west direction to about declination 58 degrees, where it ends in the bright star Achernar, a well known navigation star and one used extensively in this country in survey work. The above diagram shows the name of several stars in the group.