

*Queensland*  
**AGRICULTURAL  
JOURNAL**

JULY 1974 Vol. 100 No. 7

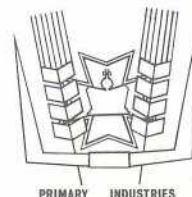

# DEPARTMENT OF PRIMARY INDUSTRIES



<b>Director-General</b>	.. .. .	J. M. Harvey
Deputy Director-General	.. .. .	A. A. Ross
Chief Advisory Officer (Administration)	.. .. .	C. L. Harris
Assistant to Director-General	.. .. .	R. V. Riley
Assistant Under Secretary	.. .. .	H. J. Evans
Director, Information and Extension Training Branch	.. .. .	J. L. Groom
Director, Fisheries Branch	.. .. .	G. G. T. Harrison
Director, Fauna Conservation Branch	.. .. .	G. W. Saunders
Executive Officer, Research Stations Section	.. .. .	G. H. Allen
Executive Officer, Extension Services Section	.. .. .	J. Gibb
<b>Director, Division of Plant Industry</b>	.. .. .	L. G. Miles
Deputy Director	.. .. .	B. L. Oxenham
Director of Agriculture	.. .. .	N. F. Fox
Director of Horticulture	.. .. .	R. C. Cannon
Director, Botany Branch	.. .. .	S. L. Everist
Director, Entomology Branch	.. .. .	T. Passlow
Director, Plant Pathology Branch	.. .. .	G. S. Purss
Director, Agricultural Chemical Laboratory Branch	.. .. .	T. J. Beckmann
<b>Director, Division of Land Utilisation</b>	.. .. .	J. E. Ladewig
Director, Development Planning Branch	.. .. .	A. Hegarty
Director of Soil Conservation	.. .. .	H. W. Pauli
<b>Director, Division of Animal Industry</b>	.. .. .	A. L. Clay
Deputy Director (Field Services)	.. .. .	L. G. Newton
Deputy Director (Research)	.. .. .	J. W. Ryley
Director of Veterinary Services	.. .. .	K. M. Grant
Biochemist	.. .. .	C. W. R. McCray
Director of Husbandry Research	.. .. .	L. Laws
Director of Pathology (A.R.I.)	.. .. .	W. T. K. Hall
Director of Sheep Husbandry	.. .. .	A. T. Bell
Director, Beef Cattle Husbandry Branch	.. .. .	B. A. Woolcock
Director, Slaughtering and Meat Inspection Branch	.. .. .	B. Parkinson
Director, Pig and Poultry Branch	.. .. .	F. N. J. Milne
<b>Director, Division of Dairying</b>	.. .. .	G. I. Alexander
Deputy Director	.. .. .	V. R. Smythe
Director of Research	.. .. .	W. C. T. Major
Director of Field Services	.. .. .	W. D. Mitchell
Director, Dairy Cattle Husbandry Branch	.. .. .	I. H. Rayner
<b>Director of Marketing</b>	.. .. .	D. P. Lapidge
Deputy Director	.. .. .	E. O. Burns
Director of Economic Services	.. .. .	N. H. Hall
Director of Marketing Services	.. .. .	D. R. Lewis
Director of Agricultural Standards	.. .. .	A. C. Peel



*A maturing passion fruit crop near Brisbane.*

Editor: A. E. FISHER

JULY 1974 Vol. 100 No. 7

Published monthly by the Department of Primary Industries, William Street, Brisbane, Q. 4000.

Telephone: 24 0414



## Parada Research Station to be Closed

THE Department of Primary Industries' Parada Research Station, near Mareeba, will be closed when current beef cattle research programmes are completed in mid 1976.

Announcing this, the Minister for Primary Industries (Hon. V. B. Sullivan, M.L.A.) said the decision to wind up current research

activities at the station, which was established in 1956, had been taken for a number of reasons.

Because of reduced resources, it was considered that they could be put to better use on other Departmental research stations on the Atherton Tableland (Kairi, Southedge and Walkamin) and wet coastal belt (South Johnstone, Utchee Creek and Silkwood).

These stations had the capacity to carry out the required research programmes for the areas serviced.

Mr. Sullivan said that extensive repairs would be necessary to maintain the Parada station in operating condition beyond 1976 and it was not proposed to initiate new research projects there.

He said that, during a visit to the station in 1972, he had advised beef producers that his Department was committed at least until 1976 on steer fattening and breeding performance trials and assured them that Parada would not be closed before then.

'The Parada station's research team has played a valuable role over the years in assisting the north Queensland beef industry, particularly in the Gulf of Carpentaria and peninsula regions,' he said.

'One of the most notable achievements was in setting world performance records for live-weight gain per acre in beef production, using heavily-fertilized, irrigated pangola grass pastures, with a peak of 1 tonne in an 11-month production period.

'The steer fattening trials have been extended to investigate the feasibility of raising breeders under similar conditions.

'This then successfully completes the series of pasture trials for which the Parada station was a very convenient centre,' Mr. Sullivan added.

## Contents

	JULY 1974	page
<b>Growing and Grazing Leucaena</b> D. G. Cooksley .....		258
<b>Vegetables for August Plantings</b> Horticulture Branch .....		262
<b>Tuberculosis-free Cattle Herds</b> .....		264
<b>Timber Control in Central Queensland—1</b> E. R. Anderson and G. R. Beeston .....		265
<b>Fostering Orphan Lambs</b> Michael Hirst .....		272
<b>Cheap Suspension Fencing for Sheep and Cattle</b> M. C. Weller and P. C. Venamore .....		275
<b>Nematode Control in Banana Planting Material</b> R. A. Broadley .....		279
<b>Highworth, a New Lablab Cultivar</b> J. H. Wildin .....		281
<b>Endeavour Stylo</b> P. D. Mortiss .....		285
<b>Bean Seed Industry in the Dry Tropics</b> R. F. Lovelady .....		289
<b>Nearly 100 Years of Beekeeping at Rockhampton</b> C. Roff .....		291
<b>Brigalow to Pasture in the North—2</b> P. V. Back .....		293
<b>Four Hovea Species</b> Beryl A. Lebler .....		297
<b>Grain Sorghum at Dalby</b> W. Bott .....		303
<b>Brucellosis-tested Swine Herds</b> .....		308
<b>Fruit Ripening Rooms</b> J. B. Watkins .....		309
<b>Farming Districts Need Bush Fire Brigades</b> N. A. Scott .....		314
<b>Farm Home</b> .....		317
<b>Meat Pie Time</b> .....		319

# Growing and Grazing Leucaena

LEUCAENA (*Leucaena leucocephala*) is the only tropical legume that so far has shown the ability to survive and produce on the heavy clay soils in the lower rainfall sections of the Burnett region. The recommended cultivar is Peru.

Other legumes will grow but they either produce little forage or do not persist under grazing on the heavy soils.

Leucaena is a native of Mexico that has spread into the Pacific region, possibly during the Spanish occupation of the Philippines. It can now be found in most low altitude regions of the tropics.

In Hawaii it grows wild in areas receiving only 610 mm annual rainfall and the Hawaiian strain is naturalized in parts of Queensland, such as around Brisbane and in the Rockhampton and Ingham areas.

A stand of Peru cultivar has been growing at 'Brian Pastures', near Gayndah (710 mm annual rainfall) for 10 years.

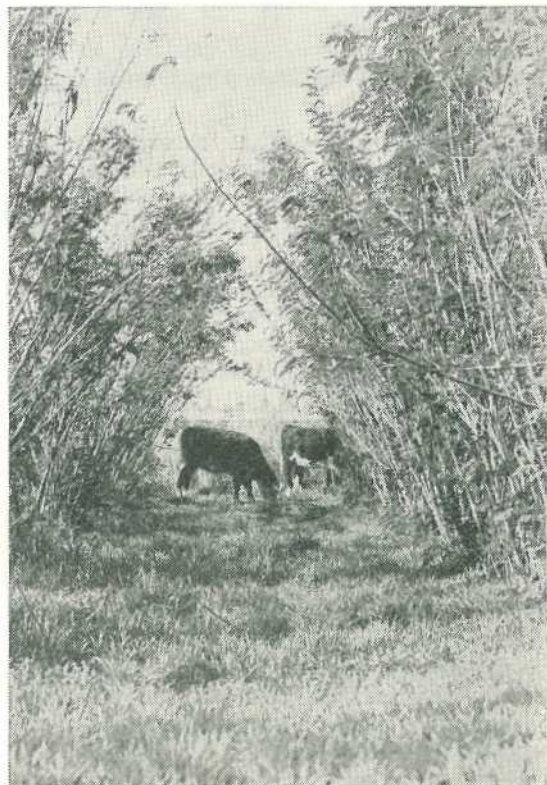

▲ Cattle grazing leucaena. Note how the leucaena stems have been bent by the cattle holding them down to graze the leaves.



▲ This leucaena plant was sown in mid October and photographed in mid April the following year. The leucaena, which was kept weed free, grew to a height of 2.5 m and also developed strong basal branches.



Leucaena, a spineless shrub, has been used for many purposes in the countries where it grows. These range from shade plants in plantations to food for cattle, poultry, pigs and even humans.

### Toxic Side Effects

Different species and cultivars of leucaena are used for different purposes and all contain varying amounts of a toxic alkaloid mimosine. When eaten by animals, mimosine produces various side effects. Chief among these is the loss of actively growing hair. The effect is proportional to the amount eaten, and large amounts can be toxic. The

mimosine content in the plant varies throughout the year and the freshly growing young leaves contain the highest levels.

The side effects from mimosine can be reduced or eliminated by careful management, and the overall benefits of the plant outweigh its disadvantages.

These disadvantages are even used to good purpose in some places. Some groups of Indonesians believe that if a boar becomes long haired it is unthrifty. They overcome this by putting the boar on a diet of pure leucaena until the hair falls out (usually after 2 to 3 weeks) without any obvious ill effects. Only by prolonged exposure is death likely to result, and loss of hair gives due warning of problems long before death occurs.

Ruminants are able to detoxify mimosine far more readily than monogastric animals such as pigs and horses. Under the grazing



*Leucaena shooting from the base in spring after having been frosted to ground level in the winter.*





This day-old leucaena seedling emerged between the soil clods. However, it is also able to lift a clod out of the way.

system used at 'Brian Pastures', where the steers are allowed access to leucaena for 3 consecutive days per week, there have been no visual signs of hair loss over 3-month periods for several years.

With dairy cows, leucaena can taint milk when fed before milking. The taint is not removed by homogenization or pasteurization, but can be reduced if the legume is withheld for 2 hours before milking or if the milk is thoroughly chilled.

#### Value for Beef Cattle

In south-eastern Queensland, cattle grazing native pasture cease to gain weight during mid autumn, lose it in winter and start to regain weight in spring. This is caused by a deficiency of protein in the forage available. At 'Brian Pastures', 18-month-old steers that had access to 0.2 hectare of leucaena and 0.6 ha of standover native pasture per head in the winter when they were calves and in the next autumn as steers were 50 kg heavier than animals that had access to 0.8 ha of similar pasture without leucaena.

#### Establishment

Leucaena can tolerate acid soils, but prefers neutral to alkaline soils that do not waterlog. Frost damage varies from loss of the exterior leaflets to death of the above ground parts. Hence it is advisable to plant away from very frosty situations.

**SEEDBED.** Growth is extremely slow in the first few months and, as leucaena has little tolerance to shading, unchecked weed growth will drastically increase the time to establishment. Hence a good seedbed needs to be prepared during winter, preferably on land that has no previous cultivation history and/or a low weed seed population.

The easiest method of propagation is by direct sowing of seed. Reports from people who have tried transplanting seedlings or planting cuttings are not encouraging.

**HARD SEEDEDNESS.** Because of hard seededness, only about 5% of the seed as harvested will germinate. It is therefore necessary to treat the seed before sowing to break the hard seed coat. For small quantities the recommended method is immersing the seed in water at 80°C for 2 minutes and then soaking in aerated or running water for 2 days. At this stage the seed will have swollen to about one and a-half times its normal weight, and should be removed before it begins to sprout. The seed is then dried (in the sun) when it will come back to its original weight. Cracks will then be visible in the testa (seed coat).

**INOCULATION.** Leucaena is highly specific in its *Rhizobium* (root nodule bacteria) requirements and must be inoculated with the strain CB-81 before planting.



**SOWING TIMES.** Low soil temperatures delay emergence. On the other hand, if sowing is left until summer, weed control can be a problem and the leucaena will not be well enough established for grazing in the first winter. As well, frost can severely damage or even kill small plants. It is recommended that sowing be done after the first suitable rain from mid September onwards. Seed should be sown into moist soil at a depth of 4 to 5 cm.

### **Plant Stand**

The most suitable plant spacing has yet to be determined. For the present, it is suggested that sufficient seed should be sown to give about six plants per metre in each row with adequate room left between rows to enable inter-row cultivation in the early stages and cattle mustering later, say 2 to 3 metres.

There are approximately 22 000 seeds per kilogram and 30% can be taken as an average emergence. If the rows are too far apart there will be a lot of inter-row grass and hence less leucaena protein per hectare.

The practice at 'Brian Pastures' is to grow the leucaena as pure stands on the better slopes and to leave the steeper hillsides under grass. A pasture of one-third leucaena and two-thirds native grass is a useful ratio.

### **Fertilizer**

Leucaena abounds naturally near limestone outcrops and prefers neutral to alkaline soils. On the black basaltic soils at 'Brian Pastures' there has been some response to added sulphur. This may be applied as gypsum, but on soils that are also phosphate deficient superphosphate will supply both phosphorus and sulphur.

### **Weeds**

On the fertile black soils at 'Brian Pastures', weed control is the most pressing problem hindering easy establishment of leucaena. At present no completely reliable recommendation on herbicide spraying can be given. The effect of adequate weed control has, however, been well demonstrated. By harvest in May 1972, leucaena that was sown in mid October 1971 was 2.3 m high when kept weed-free, but only 0.45 m high when not weeded.

On less fertile soils weed growth is less vigorous and there is evidence that effectively nodulated leucaena plants will outgrow the nitrogen-deficient weeds (See illustration page 258). This emphasizes the need for

correct inoculation of leucaena seed. In addition to thorough land preparation, mechanical inter-row cultivation and one or two hand chippings within the row during the establishment year will control weeds. Work is in progress to find a suitable herbicide application pattern.

### **Grazing**

Since pasture protein deficiencies are greatest in autumn and winter, the leucaena should be kept until then to obtain the greatest advantage from its vegetable protein. A rationing system is usually necessary, with a fresh block of leucaena being opened up for cattle each month.

Well grown young stands can be grazed at the end of the first season when about 2 m high. The cattle only graze stems down to 5 mm in diameter and therefore will not jeopardize the plants' survival. Cattle have the ability to pull or push the branches down, and slashing is usually not necessary.

Should slashing become necessary, it has no effect on the amount of material available in the following season, but there have been reports that burning reduces the following season's growth. Leucaena is unsuitable for haymaking, as the leaves are quickly shed once the stems are cut.

When the first spring growth occurs in native pastures, the need for additional vegetable protein in the animal's diet ceases and leucaena areas can be shut up and allowed to regrow unattended until they are needed again in autumn.

### **Pests and Diseases**

Some seedlings are lost by insect attacks and damping off, but these are not a serious problem.

### **Proceed Slowly**

As yet, not all the problems of establishment and management of leucaena have been solved. However, research has shown that leucaena is very valuable means of adding vegetable protein to nitrogen-deficient pastures and allowing fuller and more effective utilization of these.

As in all new ventures, however, it is wise to proceed on a small scale at first. It is suggested that a small area be established before proceeding into large-scale development, so that you can assess the value of the plant for your local situation and enterprise.

# Vegetables for August Plantings . . . by Officers of Horticulture Branch.

CROP	SUGGESTED VARIETIES*					
	Stanthorpe	Lockyer, Fassifern and Beaudesert	Coastal, South of Gladstone	Central Queensland (Gladstone to Mackay)	Bowen to Townsville	Far North Queensland (Tablelands)
<b>Bean</b>						
Fresh Market	..	Redlands Pioneer	Redlands Pioneer	Redlands Pioneer	Redlands Pioneer	Redlands Pioneer
Processing ..	..	Gallatin 50 Apollo	Gallatin 50 Apollo	..	..	..
<b>Beetroot</b> ..	..	Early Wonder Detroit strains	Early Wonder Detroit strains	Early Wonder Detroit strains	Early Wonder Detroit strains	Early Wonder Detroit strains
<b>Cabbage</b> ..	Greengold Greygreen Sugarloaf types	Ballhead Hybrid Greygreen Sugarloaf types	Ballhead Hybrid Greygreen Greengold Sugarloaf types	Ballhead Hybrid Sugarloaf types	Ballhead Hybrid All Seasons Sugarloaf types	Ballhead Hybrid Superette
<b>Capsicum</b> ..	..	Yolo Wonder Green Giant Northern Belle	Yolo Wonder Green Giant Northern Belle	Yolo Wonder Green Giant California Wonder	Yolo Wonder Green Giant California Wonder Long Sweet Yellow	Yolo Wonder California Wonder
<b>Carrot</b>						
Market ..	Topweight All Seasons Western Red	All Seasons Topweight	All Seasons Topweight	All Seasons Topweight Chantenay strains	All Seasons Topweight	All Seasons Topweight Chantenay strains
Processing	..	Royal Chantenay King Chantenay Amsterdam Forcing	Royal Chantenay King Chantenay Amsterdam Forcing	..	..	..
<b>Celery</b> ..	Local selections of South Australian strains	..	South Australian White	..	..	..
<b>Choko</b> ..	..	..	Smooth Green	Smooth Green	Smooth Green	Smooth Green



Cucumber ..	..	Green Gem	Green Gem Marketer Ashley Polaris Crystal Apple	Green Gem Polaris Ashley Crystal Apple	Green Gem Polaris Ashley Crystal Apple	Green Gem Polaris
Egg Fruit ..	..	Market Supreme	Market Supreme Mission Belle Long Purple	Market Supreme Long Purple	Market Supreme Long Purple	Market Supreme Long Purple
Lettuce ..	Yatesdale Pennlake	Yatesdale Pennlake	Yatesdale Pennlake	Pennlake Yatesdale	Pennlake Great Lakes strains Yatesdale	Yatesdale Pennlake
Marrow ..	..	..	Long White Bush	Long White Bush	Long White Bush	Long White Bush
Zucchini ..	..	..	Blackjack Ambassador	Blackjack Ambassador	Blackjack Ambassador	Blackjack Ambassador
Melon Rock ..	..	Conqueror Rio Gold Hales Best	Conqueror Rio Gold Hales Best	Hales Best Conqueror Rio Gold	Hales Best Gulfstream Gold Pak	Rio Gold
Water ..	..	Candy Red Calhoun Grey	Candy Red Calhoun Grey Warpaint Mini Melons	Candy Red Calhoun Grey Charleston Grey	Candy Red Crimson Sweet	Candy Red Sunny Boy
Parsnip ..	..	..	Hollow Crown	..	..	..
Pea Fresh Market	Greenfeast	Massey Gem	Massey Gem	..	..	..
Processing	..	Freezer strains Frosty	Freezer strains Frosty	..	..	..
Pumpkin ..	..	Queensland Blue	Queensland Blue Butternut	Queensland Blue	Queensland Blue	Queensland Blue Butternut
Rhubarb ..	..	..	Sydney Crimson Local strains	..	..	..
Tomato ..	Grosse Lisse strains College Challenger Indian River	Floradel Indian River Grosse Lisse strains Tropic Strobelee Walter	Floradel Indian River Grosse Lisse strains Tropic Strobelee Walter	Floradel Indian River Grosse Lisse strains Tropic Strobelee	Walter C 1402 Floradel	Floradel Tropic Indian River

\*These suggestions are based on the more important commercial varieties.

# Tuberculosis-Free Cattle Herds (As at June 13, 1974)

## ANGUS

Corden, E. B., Netherby, Warwick  
Crothers, H. J., "Mooreenbah", Dirranbandi  
Mayne, W. H. C. & Sons, "Gibraltar", Texas

## A.I.S.

Cox, T. L. & L. M. J., Seaford Farm, Wallumbilla  
Davis, W. D., "Wamba", Chinchilla  
Evans, E. G., Lauraven A.I.S. Stud, Maleny  
Franz, E. L. and E. L., "Amabar" A.I.S. Stud, Amamoor, via Gympie  
Henry, Mrs. K. & Sons, "Tara", P.O. Box 4, Cambooya  
H. M. State Prison Farm, Numinbah  
Klein Bros., Kapleton A.I.S. Stud, Ma Ma Creek, via Grantham  
Lawley, E. D. & Sons, Arley A.I.S. Stud, Maleny  
Marquardt, C. R. & J. L., Cedar Valley A.I.S. Stud, Wondai  
Martin, J. P. & R. J., Kentville, via Forest Hill  
Middleton, C. W., Airton Vale, Cambooya  
Mitchell and Mulcahy, Rosenthal  
O'Sullivan, P. W., "Navleigh", M.S. 371, Greenmount  
Phillips, J. & Sons, "Sunny View" A.I.S. Stud, Kingaroy  
Pagel, E. E., and Hayes, E. M., Trafalgar Stud, Tarampa, via Lowood  
Queensland Agricultural College, Lawes  
Ross, W. & Co., M.S. 23, Rosewood  
Schelbach, N. N. & Co., Allanview Stud, Warwick  
Scott, W. & A. G., "Walena" A.I.S. Stud, Blackbutt  
Siebenhausen, J. & S. C., "Meniton", M.S. 195, Pittsworth  
Thompson, W. H., "Alfa Vale", Nanango  
Vohland, A. R., Bevallan, Stoneleigh, M.S. 150, Pittsworth  
Weier, L. G., Prairie Plain A.I.S. Stud, M.S. 765, Allora

## AYRSHIRE

Goddard, B., Inverell, Mt. Tyson, via Oakey  
Ross, E. D. & Co., "Ardrossan", Crediton, Mackay  
Scott, J. N. & Son, "Auchen Eden", Camp Mountain  
Zerner, G. F. H., "Pineville", Pie Creek, Gympie

## BRAFORD

Bowden, W. H., "Brendale", South Pine Road, Strathpine  
Thompson, M. A. K., "Glen Kyle", Buderim

## FRIESIAN

Behrendorff, E. C. & N. G., Inavale Friesian Stud, M.S. 786, Boonah  
Chamberlain, C. H., Sherwood, Rocks Road, Gympie  
Evans, P. J., M.S. 28, Dragon St., Warwick  
Goodwin, A. T. & P. M., Winabee Stud, Killarney  
Guppy, N. J. & H. M., Bli Bli Road, Nambour  
Hickey, K. A. & M. R., Bunya  
Lobley, N. E., "Neloby", Mt. Pleasant, via Dayboro  
McWilliam, A. A., Oatlands Stud, M.S. 918, Toowoomba  
Martin, R. J. and E. L., Kentville, via Forest Hill  
Norgaard, M. J. & B. F., Yarrabine Friesian Stud, Yarraman  
Pantram, J. & K., Blenheim, via Laidley  
Queensland Agricultural College, Lawes  
Robert-Thompson & Co., A. D. and R. M., M.S. 411, Beaudesert  
Staines, R. V., Bowhill Rd., Oxley South  
Stumer, A. O., Brigalow, Boonah  
Vonhoff, A. R. & D. G., M.S. 918, Toowoomba

## GUERNSEY

Dionysius, R. L. & L., Warana Stud, M. S. 1796, Proston  
Gibson, A. & D., Mooloo, via Gympie  
Holmes, C. D. (owner Holmes, L. L.), "Springview", Yarraman  
Hopper, G. T. & H. W., Ellendean Guernsey Stud, Maleny  
Scott, Cecil & C. A., "Coralgrae", Din Din Rd., Nanango  
Smith, Mrs. E. P., Remleigh Guernsey Stud, Imbil  
Wilson, R. A. and M. R., "Okeden", Proston

## HEREFORD

Hill, W. W. & P. C., "Mathalla", Dirranbandi  
Panorama Stud Pty. Ltd., M.S. 765, Allora

## JERSEY

Conochie, I. S., Brookland Jersey Stud, M.S. 461, Kalbar  
Forsyth, D. E., Kobarnie Stud, Mulgildie, Q., 4629  
H. M. Prison Farm, Capricornia Stud, P.M.B. 11, Rockhampton  
H. M. State Farm, Palen Creek  
Hodgens, G. & J. F., "Bunyeris", Peachester  
Lau, J. F., "Rossallen", Goombungee, Toowoomba  
Mahaffey, H. W. & V. N., "Goombooran", via Gympie  
McDonald, R. G., "Buffelvale", M.S. 807, Mundubbera  
Newton, J. C. & A., Merryvale, Upper Caboolture  
Paulger, S. & S. M., "Advale", Kenilworth  
Perkins, M. J. & E. M., Byee Jersey Stud, M.S. 692, Sth. Nanango  
Postle, R. S. & G. C., "Yarallaside", Pittsworth  
Queensland Agricultural College, Lawes  
Scott, P. E., "Kiaora", Manumbar Rd., Nanango  
Semgreen, A. L., "Tecoma", Coolabunia  
Snare, A. E. & Son, Laidley Park Stud, Laidley, 4341  
Spessor, O. W., Carnation Jersey Stud, Mt. Walker Rd., Rosewood  
Todd, J. R., Aberfoyle, Laravale, via Beaudesert  
Vohland, A. R., Bevallan, Stoneleigh, M.S. 150, Pittsworth  
Wadley, D., "Nindethana", Moggill  
Waite, H. M., M.S. 182, Laidley  
Westbrook Training Centre, Westbrook

## POLL HEREFORD

Anderson, J. H. & Sons, "Inverary", Yandilla  
Christensen, B. L. & M. O., "Elavesor", Rosevale  
Morris, H. J. & D. I., Gaview Stud, Clifton  
Nee Nee Pastoral Co., Dirranbandi, 4392  
Stiller, N. L., "Vine Veil", Guluguba

## POLL SHORTHORN

Leonard, W. & Sons, "Welltown", Goondiwindi  
Pointon, R. B. & S. C., "Wyyurri", M.S. 780, Kingaroy

## BRAHMAN

Queensland Agricultural College, Lawes  
The Cherokee Group Brahman Cattle Co., Tanby

## SANTA GERTRUDIS

Barbara Plains Grazing Co., Barbara Plains, Wyandra  
Central Estates, Comet Downs, Comet

## SHORTHORN

Pointon, R. B. & S. C., "Wyyurri", M.S. 780, Kingaroy

## DROUGHTMASTER

University of Queensland, Veterinary School, St. Lucia



# Timber Control in Central Queensland—1

by E. R. ANDERSON, Agrostologist;  
and G. R. BEESTON, Ecologist.

REMOVING unwanted trees and shrubs is a major problem in increasing and maintaining grassland production in most beef raising areas of Queensland.

Many species are involved and wide variations in climate and soil also occur.

## Is total clearing necessary?

Extensive and complete destruction of trees and shrubs is undesirable for aesthetic, conservation and, often, economic reasons. It should be possible to retain some trees and shrubs and still obtain an economic level of grass and herb production, and a stable plant-soil-animal system.

Other things to be considered are shade and shelter, ease of husbandry operations involving domestic livestock, and the preservation of habitats for native birds and other animals. An additional reason for keeping some shrubs is their feed value in times of drought.



Coastal hills in the Mackay region infested with *zamia* (*Cycas* sp.) (plate 1).



C.S.I.R.O. scientists of the Woodland Ecology Unit working with poplar box (*Eucalyptus populnea*) in a 500 mm annual rainfall area in southern Queensland found that trees reduced herbage production more than shrubs. Maximum production was still achieved with about six trees or 360 shrubs per hectare.

Areas such as gullies, stream banks, 'jump-ups' and tops of small hills should never have timber removed. Clearing these areas increases erosion and can also result in salting of lower areas.

It should be realized that the wholesale removal of woody vegetation can cause an imbalance in the ecological system. Instead of improving grassland production, the opposite may occur through the regeneration of woody species or the encroachment of inferior pasture species.

Regeneration of woody species can occur from regrowth of the original plants, suppressed seedlings or seed. Therefore, except in getting rid of poisonous plants such as zamia (*Macrozamia* spp., or *Cycas* sp.) (see plate 1) and poison peach (*Trema aspera*), timber control should never be carried out solely to remove unwanted plants but only to improve the present pasture or to introduce an improved pasture.

### Methods of timber control

Timber can be controlled by several methods used either alone or in combination. With mechanical treatment, the land is cleared by chaining or pushing and soil disturbance results. Alternatively, chemicals can be applied by stem injection or by cutting down the plant and swabbing the butt (cut stump).

In this, the soil is not disturbed so that, unless a pasture species can be introduced into the undisturbed soil, any improvement of the pasture depends on a response from the species already present. Furthermore, with chemical treatments, care has to be taken that the chemical itself has no residual toxic effects on legume-based pastures.

Regrowth that occurs after these treatments can be controlled by ploughing, overall spraying or basal bark spraying depending on the situation and the species involved.

Finally, fire and the adjustment of grazing pressures can be used. Fire may sometimes reduce the population of unwanted species but at others it acts as a stimulant. In other situations, fire can be used to hold regrowth in check but this situation is fraught with danger because of variable rainfall. Fire is usually considered when regrowth is beginning to get out of hand.

To obtain a burn, the paddock needs to be unstocked for a while to permit the build up of grass fuel. If the season turns unfavourable and the area is again stocked, the chance for a burn is lost. When this happens, the regrowth takes a stronger hold and the pasture will decline further and may not be able to provide sufficient fuel for a future burn.

In some situations heavy grazing can help to keep woody regrowth in check but, at the same time, it may harm the pasture species and thus animal production.

This series of articles deals with the area from Proserpine in the north to Miriam Vale in the south, and west to approximately the 600 mm annual rainfall line. The major communities can be separated into those of the coastal and inland areas.

**Coastal.** In these areas, mean annual rainfall is generally greater than 1 100 mm. Landforms included are lowlands mainly dominated by tea-tree (*Melaleuca* spp.) and uplands dominated by eucalypt communities and rain-forest.

**Inland.** In these areas, mean annual rainfall is less than 1 100 mm with a large proportion of the area receiving less than 750 mm. The main areas are the brigalow (*Acacia harpophylla*) and eucalypt communities.

## CONTROL IN COASTAL AREAS

### A. Lowland areas

The lowland areas are usually flat and poorly drained. They are generally dominated by tea-trees, with long-fruited bloodwood (*Eucalyptus polycarpa*), poplar gum (*Eucalyptus alba*), swamp mahogany (*Tristania suaveolens*) and swamp oak (*Casuarina glauca*). Grass-trees (*Xanthorrhoea* spp.) are common except in very wet situations.



These areas have few useful native grasses and support little if any animal production in the uncleared state.

**MECHANICAL CONTROL.** The method is to pull the standing timber, rake, stack, burn, plough, fertilize and plant pasture species. Ploughing should be deeper than 10 cm to damage the roots of the original trees severely and to remove seedlings.

To obtain a vigorous pasture, adapted species must be planted and adequate fertilizer applied. When this is done, regrowth is usually only a minor problem and can be controlled by slashing.

Pasture species available include:—

Grasses: Kazungula setaria (*Setaria anceps*), Rodd's Bay plicatum (*Paspalum plicatum*), signal grass (*Brachiaria decumbens*), and pangola (*Digitaria decumbens*).

Legumes: Siratro (*Macroptilium atropurpureum*) and stylo (*Stylosanthes guyanensis* cv. Schofield).

The expected carrying capacity is a beast to 0.6 to 0.8 hectares for grass-legume pastures and a beast to 0.4 hectares or less for pure grass-nitrogen fertilized pastures.

**CHEMICAL CONTROL.** In this operation, trees are killed by injection with 'Tordon 105 Treekiller' and the fertilizer and pasture species are usually sown aurally.

C.S.I.R.O. scientists of the Woodland Ecology Unit have found that tree injectors with cutting blades 2.5 to 5 cm wide give better control than axes with a 12 cm blade. An axe blade reduced in width (to 5 cm) and modified to make a cut similar to that of a tree injector can give comparable results to those obtained with a tree injector.

Irrespective of the implement used, complete penetration of the bark into the sapwood is essential for good kills. If the bark is not penetrated movement of chemicals throughout the tree is poor and percentage kills are usually low.

Injections should be made at 10 to 12 cm centres. That is 10 to 12 cm between the centres of the cuts. (See plate 2). Injections at the base of the tree are often more effective than those made at waist height. However, they can be just as effective at waist height

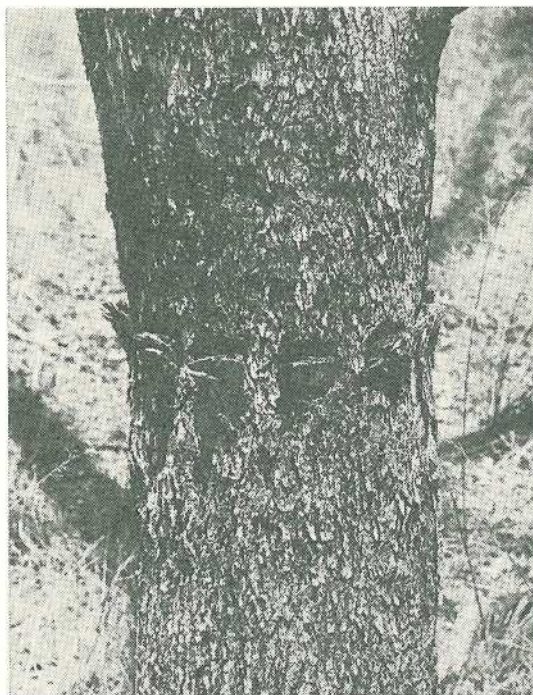

Poplar box trees treated by injection at waist height with the 5 cm blade of a tree injector. Cuts are correctly spaced at 10 to 12 cm between centres (plate 2).

when the amount of chemical applied is the same as that which would be required for basal injection. This is done by calculating the number of injections that would be required for basal injection and applying this number at waist height.

The annual, Townsville stylo (*Stylosanthes humilis*), with molybdenum (Mo single) superphosphate is sown. The use of the pasture species listed in the mechanical control section is hazardous as a seedbed is not prepared and establishment is difficult. Stylo will establish, but its persistence on the wet lowlands (particularly between Proserpine and Carmila) is doubtful.

The Tordon treatment is applied between June and January, and the Townsville stylo is sown in December. Before sowing, the area should be burnt (preferably) or grazed heavily.



The attraction of this method is its relative cheapness compared with complete clearing and cultivation, although the carrying capacity is less—a beast to 1.2 to 1.6 hectares. (See Table 1 for comparison of costs).

TABLE 1

AVERAGE COST PER HECTARE OF PASTURE ESTABLISHMENT IN COASTAL LOWLAND AREAS BY MECHANICAL AND CHEMICAL CLEARING

METHOD	TIMBER TO SEEDBED	SEEDBED TO PASTURE	TOTAL
	\$	\$	\$
Mechanical ..	95.00	52.50	147.50
Chemical ..	12.50	28.75	41.25

With correct management, the mechanical method results in a stable pasture, but the chemical method often results in a heavy regrowth problem. The pasture introduced following chemical treatment is not a strong competitor and regeneration of the original timber from seedlings, especially suppressed seedlings, is profuse.

A regrowth rate of 0.6 m a year for seedlings is not exceptional. This limits the useful life expectancy of the pasture to 5 to 8 years. Remedial measures are often required after 3 years if a rapid decline in production is to be arrested.

An example of the seedling regrowth following the chemical killing of the original tea-tree timber is shown in Table 2.

Remedial measures may follow two lines. The first is chemical re-treatment in which the regrowth is cut at ground level and the butt swabbed with Tordon 105. The second line is to employ mechanical methods in which the dead timber is pulled, stacked and burnt, and the regrowth plough out.

Chemicals can be used up to a certain density of regrowth, but situations will occur where the problem is physically difficult and economically unjustified to treat.

With mechanical re-treatment, a stable perennial pasture can be established. With this procedure, the cost from 'dead timber' to seedbed is less than if mechanical methods were used to clear the timber originally. In addition, the perennial pasture can take advantage of the fertility build-up from the Townsville stylo of the earlier pasture.

Although the chemical system has the disadvantage of producing initially an unstable system and hence contains a certain risk, it has economic attractions. It allows the development of moderately productive pastures for a relatively low capital input. More refined development can be then incorporated as revenue is generated from the previous investment.

## B. Upland areas

The major vegetation of the upland areas is eucalypt forest on undulating, fairly well drained land. Species include narrow-leaved ironbark (*Eucalyptus crebra*), poplar gum,

TABLE 2

TEA-TREE SEEDLING REGROWTH AFTER THE ORIGINAL TREES HAD BEEN KILLED BY CHEMICAL TREATMENT. THE ORIGINAL TREE POPULATION WAS APPROXIMATELY 17 500 TREES/HA

Length of Treatment (expressed as the number of growing seasons after chemical treatment)	Number of seedlings/ha		Approximate height of seedlings
	Average	Range	
1 season (plate 4) .. .. .	56 900	37 500-78 500	0.15 to 0.3 m
2 seasons (plate 5) .. .. .	33 800	17 500-60 100	50% : 0.3 to 1.2 m 75% : less than 0.6 m
3 seasons (plate 6) .. .. .	17 000	14 300-18 800	75% : 1.2 to 2.4 m 25% : less than 0.6 m
4 seasons (plate 7) .. .. .	17 100	16 500-17 900	75% : 1.2 to 3.7 m 25% : less than 0.6 m





grasses (*Bothriochloa* spp. and *Dichanthium* spp.), golden-beard grass (*Chrysopogon fallax*) and scented top (*Capillipedium parviflorum*).

The trees can be killed by injection with Tordon 105 treekiller and, where the native grass species are not vigorous, either annual Townsville stylo or perennial Schofield stylo can be planted with 250 kg per ha of Mo single superphosphate. This situation often occurs in areas that do not lend themselves to cultivation because of slope and shallow stony soils. The problem of erosion should



These four pictures are of tea-tree seedling regrowth following the death of the original trees which were injected with Tordon 105. In the pictures, the original trees have been killed for 1 (top left) 2, 3 and 4 growing seasons (plates 3, 4, 5 and 6). (See also table 2).

Moreton Bay ash or carbeen (*Eucalyptus tessellaris*) and pink bloodwood (*Eucalyptus intermedia*).

In this situation, a vigorous native grass pasture is usually present and this makes it difficult to introduce improved pastures without cultivation. The range of pasture species found includes black spear grass (*Heteropogon contortus*), kangaroo grass (*Themeda australis*), native sorghums (*Sorghum* spp.), blue







*Poplar gum and narrow-leaved ironbark on hilly country killed by chemical treatment (injection with Tordon 105) and Schofield stylo established (plate 7).*

also be considered and for this reason the perennial Schofield stylo is the preferred legume.

Where mechanical treatment is possible, it is similar to that described earlier for the coastal lowland areas. A similar range of pasture species is available. Additional species include Hamil grass (*Panicum maximum*), and the legumes Tinaroo glycine (*Glycine wightii* cv. Tinaroo) and centro (*Centrosema pubescens*).

Some eucalypt regrowth from the bulbous underground stems (lignotubers) does occur as ploughing is often not as efficient as on flat lowland country. This regrowth can be controlled by hand-slashing and swabbing the cut stumps with Tordon 105.

Generally, a more vigorous pasture develops on upland country than on lowland country because of the better drainage and better soil. The expected carrying capacity is a beast to 0.6 to 0.8 hectares.

### C. Rain-forest

Rain-forest occurs in a variety of forms as a discontinuous belt along the coast and adjacent highlands. It reaches its best development on fertile soils where the rainfall is well distributed and 1 200 mm or more annually.

The largest areas are from Prosperpine to Mackay and west to the Eungella Range. Because of the size and density of timber, mechanical development is the only feasible



method. The timber is felled with chain saws, or bulldozed at a cost of \$75 to \$125 per hectare, subsequently burnt, and fertilizer and pasture seed are distributed into the ashes. Suitable species are:—

Grasses: setaria, molasses (*Melinis minutiflora*) and Hamil.

Legumes: Greenleaf and Silverleaf desmodium (*Desmodium intortum* and *D. uncinatum*), Tinaroo and Clarence glycines and Siratro.

Establishment fertilizer ranges from 400 to 750 kg per ha of Mo superphosphate depending on the initial soil fertility. Maintenance fertilizer (250 to 500 kg per ha of superphos-

phate a year) is essential to maintain a vigorous pasture. At first, heavy infestations of annual weeds occur but these disappear in subsequent years if a vigorous pasture is maintained.

Other problem weeds include lantana (*Lantana camara*), devil's fig (*Solanum torvum*), poison peach, and regrowth from rain-forest woody species. All of these can be successfully treated by basal bark spraying with 'Tordon 255' (on regrowth up to 2.5 cm diameter stem thickness) or cutting and swabbing the stump with Tordon 105.

[TO BE CONTINUED]

---

## Breeders Should Calve Each Year

A beef cattle husbandry expert said one calf from each cow in the breeding herd every 12 months should be the aim of every beef cattle breeder.

Mr. M. A. Burns, District Beef Cattle Husbandry Adviser in the Queensland Department of Primary Industries, said: 'A calf from most of the cows in every year with a calving interval of more than 12 months is an unacceptable compromise.'

Mr. Burns was speaking at a field day attended by about 90, on the property of Mr. A. Gardner, Coal Creek, Esk. The field day was organized by the West Moreton Regional Extension Committee of the Department and by the Queensland Branch of the Australian Society of Animal Production.

'The Beef Cattle Husbandry Branch has devised a simple but practical breeding herd management programme based on the concept of conserving body condition, mating for a restricted period on a rising plane of nutrition and not allowing the cow to lactate for too long on poor feed,' he said.

The mating period, he said, extended from November to February or March, fulfilling the need to mate on a rising plane of nutrition. The controlled mating gave a calving

from mid August to November or December, the period resulting in heavier weaning weights of calves.

Weaning not later than early May and preferably from late March to mid April was an essential part of the programme. This was aimed at reducing the lactation stress of the cow and giving her time to recover before the winter and to calve in strong condition.

'This programme is being employed with a high degree of success by leading cattlemen in the Brisbane Valley and other parts of south-east Queensland,' Mr. Burns said.

'Evidence of the success of the management programme is pregnancy rates regularly of 90% or higher in herds where the programme has been adopted.'

Mr. Gardner said that he bought the property in 1969 and in 1970 a pregnancy percentage of 77.6 was achieved.

'We asked the D.P.I. for help, and Max Burns laid down a simple, sound, practical form of herd management which has been strictly adhered to.

'The pregnancy rate has been lifted 20% to 96.6%,' he said.

# Fostering Orphan Lambs

WITH increased sheep prices, both for prime lambs and for woolgrowers, every lamb reared represents a lot of money, but even when prices were low many graziers still reared orphan lambs on a bottle.

Fostering or 'mothering on' these lambs onto other ewes would have resulted in better lambs and a big saving in time and money. Only

---

by MICHAEL HIRST, 'Carnbrea', Bowenville. The author is a practical sheepman who draws on his long experience in fostering lambs, to pass on some hints to other graziers.

---

in exceptional circumstances will this method apply to extensive forms of sheep husbandry where the ewes, after all precautions have been taken for their welfare, are left alone until lambing is completed.

However, where ewes are inspected once or more a day, orphan lambs can be spotted at once, together with those ewes that have lost a lamb or those that have twins and insufficient milk or, say, a blind teat. It is especially suitable for situations where the newly lambed ewes are 'drifted' out every day.

## Suitable Ewes

Not only British breed cross ewes but also Merinos will readily take lambs provided they have ample milk, have been quietly handled

and the right technique is employed. Maiden ewes can be tricky and, if they have not much milk, are often best left 'dry'. However, those in good condition will take a lamb well if they are not stirred up.

Obviously, very weak or sickly ewes should be avoided, though ones that merely have had a hard time lambing, or perhaps 'hung' their lamb (the most common source of foster mothers), should not be discarded but given a little time to recover.

## Suitable Lambs

Orphans, mismothered lambs, undernourished twins and pets can all be fostered if they are healthy. Quite old lambs, up to 3 or 4 weeks, can be mothered, but a lamb that has been a pet for as long as this sometimes takes a bit of coaxing to take another ewe even though she is keen on it. A bit of patience is needed in this situation. Hunger is a powerful persuader.

But the time spent with even the most stubborn ewe or lamb is only of a fraction of the total time spent hand-rearing. Once orphan lambs are mothered on they need no more attention than any other member of the flock. I suppose that, in more than 30 years spent with lambing ewes in Scotland and Australia, I must have mothered on hundreds with very few failures, and those mostly with sickly lambs that would have died anyhow.

Incidentally, when splitting twins, always take the stronger to foster, leaving the weaker on its own mother.



## Equipment

The only equipment needed is a small pen, a pocket knife and possibly a bottle of Dettol\* or other mild but strong-smelling disinfectant. The smaller the pen the better, a hurdle across the corner of a yard will do. I often use a crate that is only just big enough to fit on a tractor carry-all and often split that in two if I have two patients. The pen cannot be too small, often it is too large.

A bowl of water and a bit of hay are sometimes needed as it is essential not to let the ewe lose her milk, though often the pair can be turned out in 24 hours, or less if you are sure of your ewe.

## Recruiting

The frustrating part of the business is when you have orphans but no ewe or bereaved ewes and no lamb. This is most likely to happen at the beginning or the end of lambing. We feed the orphans until we get a mother for them. Since we began using nothing but refrigerated milk we have had very little trouble: warming the milk merely incubates the 'wogs' and we killed many lambs that way.

We feed Denkavite† at 50% over strength. If we have a ewe and no lamb I 'drift' her out and keep her 'up my sleeve' for a bit. This season, I successfully used two ewes that had lambed more than a week before I found lambs for them. One had also been very ill having had decomposed twins removed from her, yet she reared a very good lamb.

In the hill sheep districts of Scotland and the north of England a barter trade took place in pet lambs for fostering: if you had none you begged one from a neighbour.

## Method

The simplest and surest method is when you have the body of the dead lamb. Put the ewe into the pen with it, well away from other sheep, for a short time. Then take the dead lamb away and skin it out of sight. First cut off the legs at the knees and hocks, then make a V-slit from half way up the bare inside of the thighs to the crutch, work out the hind legs through this, then pull the skin

inside-out over the body, working out the forelegs and cutting the skin right round the neck to free the head. Turn right side out. Then, put the skin on the lamb to be mothered; over the head first, then insert the forelegs into their respective sleeves, and finally the hindlegs being very careful not to bend them the wrong way. The head will be uncovered so smear it with blood, faeces and/or slime from the skin.

Introduce the lamb to the ewe by pushing the lamb under her so that she will smell first the lamb's rump, which is well covered, rather than the head. Most ewes will accept the lamb straight away, but some you will have to restrain if they are suspicious of the lamb or you may have to help the lamb find the teat. Hold her against the side of the pen while the lamb drinks, gradually relaxing your hold until she allows it to suck on its own.

In such cases, little and often is the rule come back frequently for a few minutes; in a short time the lamb will go under to drink as soon as you come into the yard and the ewe will gradually take it. Usually the skin can be taken off within 24 hours or less. By that time, both the skin and the lamb smell alike, but beware of blowflies.

If the ewe has taken the lamb, let the pair out in a small paddock near the yard first. Sometimes, in difficult cases, this has to be done before the lamb is properly mothered so that the ewe can get a feed. In these cases, bring them in at night. During the day you can get the lamb to suck by holding the ewe up with a dog in the corner of the paddock.

Difficult ewes will often take the lamb in the pen if a dog is brought up to it, this arouses her maternal protective instinct and while she is stamping her feet she will often let the lamb suck. A ewe may butt the lamb first time and trample all over it, yet next time you visit she will be letting it suck with no fuss.

Don't be put off by these difficult cases, most ewes will take a foster lamb straight away if they have milk. Although it sounds a lot of work, even the least co-operative will probably involve only five or six visits a day, for possibly 1, 2 or, at the most 3 days. This is a fraction of the time that would be spent on hand-rearing.

\* Proprietary product

† Proprietary feed

### Cases with No Skin

When you cannot find the dead lamb and so have no skin, disguise the lamb's smell by smearing Dettol on the lamb and the ewe's nostrils **before** introducing the lamb. Old, motherly ewes will often take a lamb straight away with nothing, as long as they are penned close and the lamb is pushed under a few times to suck. I have not tried any of the proprietary mothering agents, but imagine they work on the same principle as Dettol and feel they would not succeed unless accompanied by the methods outlined above.

### Do's and Don'ts

Here are the important do's and don'ts of fostering orphan lambs—

- Don't forget to check the ewe's udder first. It is frustrating to mother a lamb successfully on to a ewe with two blind teats.
- Don't just open the gate, check that the lamb will follow after being released from the pen. Then, put the lamb out first so that the ewe will run to it.
- Don't box the pair with the main mob straight away. Keep them by themselves or with a few others for a few days so they may be checked.
- Don't, if you have split twins, put them back in the paddock with the original ewe until she has had time to forget her second lamb.
- Don't keep the ewe in so long that she loses her milk. If necessary, give her hay and water or let her feed out in the daytime.
- Do clip ewe's udder if too woolly.
- Do split twins if the mother is short of milk and a good foster mother is available.
- Do persevere. An apparently hopeless case may be sucking at the next visit.
- Do remember, a mothered-on lamb does not become a spoiled pet eating your wife's roses.

---

## Quail and Partridge Declared Poultry

THE Minister for Primary Industries (Hon. V. B. Sullivan, M.L.A.) has announced that action has been taken to include Japanese quail and partridges in the definition of poultry under both the Meat Industry Act and the Poultry Industry Act.

This flows from plans by commercial interests to breed both species of birds in captivity and to process them to meet a

growing demand from the restaurant trade for exotic forms of game meats, Mr. Sullivan said.

The inclusion of these birds in the definition of poultry under the Meat Industry Act will necessitate their treatment in registered poultry abattoirs, and a similar inclusion under the Poultry Industry Act will enable controls to be maintained in regard to live birds in breeding flocks.





# Cheap Suspension Fencing for Sheep and Cattle

- *This fence is half the cost of the old type fence and requires less maintenance.*
- *The cheapest and most effective fence I've ever built.*
- *All classes of sheep and cattle, even scrubbers, respect this fence.*

These are some of the remarks about sheep-cattle suspension fences made by south-western graziers who see them as a partial answer to an important problem.

With favourable long-term prospects for beef, traditional woolgrowers in western areas are leaning towards cattle as a hedge against fluctuations in wool prices. On many properties, this means that fences have to be improved or even completely rebuilt to permit adequate cattle control and management.

In these extensive areas, suspension fencing is gaining favour through its effectiveness, easy erection and low cost.

## Idea Not New

Suspension fences have been used to control beef cattle in Queensland for the past 10 to 15 years and they have been used in America

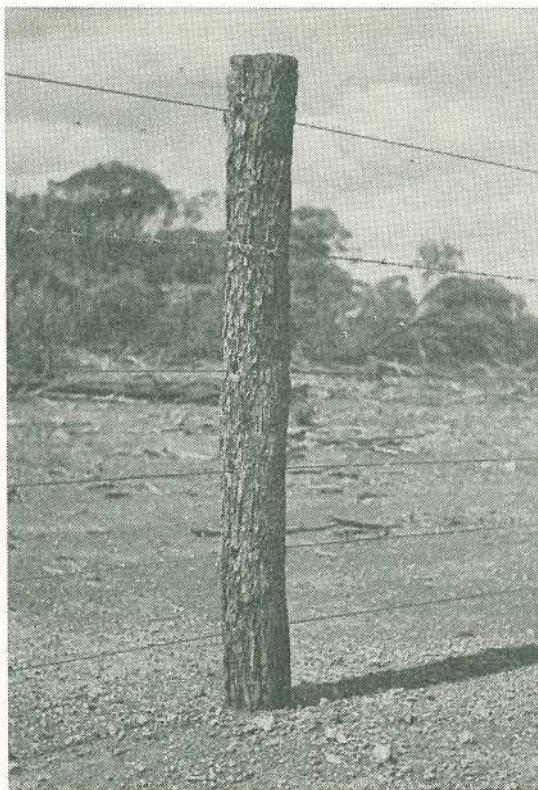

▲ Plain wires are half the cost of barbed and easier to handle. This inexpensive fence will hold both cattle and sheep.

---

by M. C. WELLER and P. C. VENAMORE, Beef Cattle Husbandry Branch.

---

Suspension fences controlling both sheep and cattle are a common sight in South-western Queensland. ▼

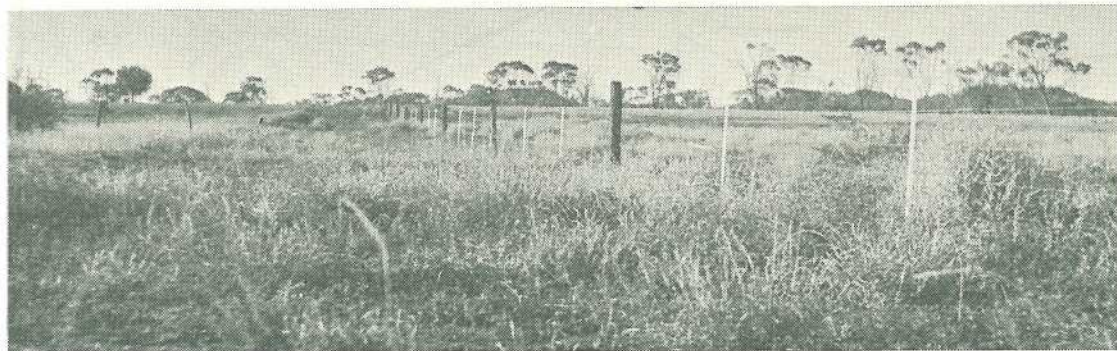

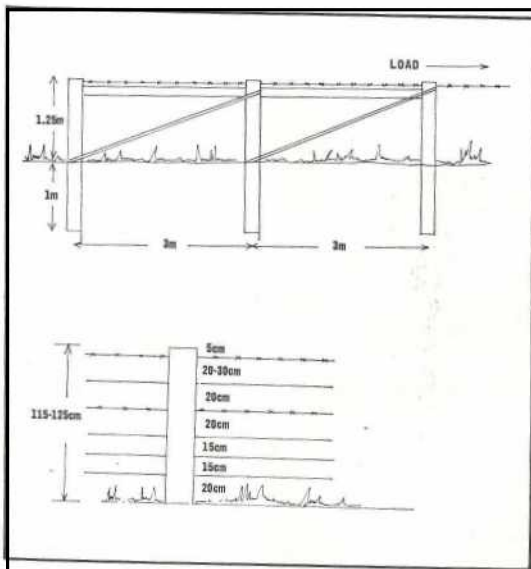

▲ TOP. One recommended end strainer assembly showing the horizontal wooden stays and the diagonal wire twitches.

BOTTOM. A fence design to hold both sheep and cattle: 4 plain wires (2.5 mm high tensile 'Tyeasy'), 2 barbed wires (1.6 mm high tensile), strainers (every 400 m), steel posts (every 20 to 30 m), droppers (every 6 to 7.5 m). Sometimes one barbed strand is replaced by a plain wire and the remaining barbed strand placed second from the top.

Another recommended strainer assembly using 12 mm (½ in.) metal rod in preference to the normal wire twitch. The compression post A is used, as a rule, only on heavy clay soils or flooded country. ▼

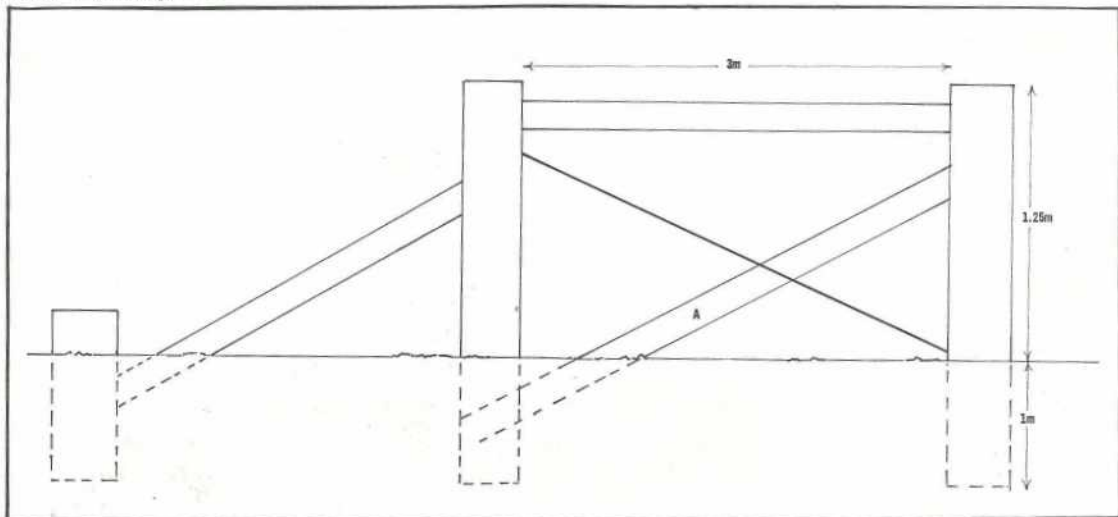

for more than 30 years. However, it is only recently that graziers have been adapting the design to a combination sheep and cattle fence.

This type of fence retains the principle of flexibility. Fence posts are placed at 20 or 30 m intervals and three or four droppers are evenly spaced in each panel. Special strainer stays are essential at fence ends and at corners where strainer posts support heavy loads. The basic change with this style of fence is the number and type of wire used.

### Principles

With strains 400 m long, the load on strainer posts reaches 1 400 to 1 800 kg. The special, double-panel, horizontal stay assembly is recommended for gateways and corners to carry the load. On occasions, this assembly has failed where it has been built on flooded country or heavy clay soils. In these cases, local graziers incorporate the use of bed-logs or a combined diagonal-horizontal assembly.

If possible, avoid strains shorter than 400 m: these are difficult to keep tight. Place either steel or wooden posts at 30 m intervals; this is the length of one panel of a suspension fence. If using prefabricated wire, a 20 m panel is sufficient. Shorter panel lengths reduce the flexibility and therefore the effectiveness of the fence.

Wire spreaders or droppers are placed at 7.5 m intervals within each panel. They are suspended and locked in a vertical position



when attached to the wires. The spreaders maintain the desired wire spacing throughout each panel.

### Wire and Tension

The use of correct wires at recommended tensions is essential for an effective and long-lasting fence. Only high tensile wire should be used: it is usually cheaper, and always more elastic. The following table offers a comparison of the more common types:—

WIRE STRENGTHS AND COSTS  
(ex Brisbane, late 1973)

Type	Break Load kg	Weight per km kg	Cost per km
S.T. = Standard tensile H.T. = High tensile			
<b>Plain</b>			
4.00 mm S.T. ..	700	102	\$22.88
3.15 mm S.T. ..	450	68	\$14.94
2.80 mm H.T. ..	800	54	\$15.38
2.50 mm H.T. .. (Tyeasy)	550	38	\$10.66
<b>Barbed</b>			
2.5 mm (90 wa) ..	450	112	\$30.88
1.6 mm H.T. (Reverse twist)	450	50	\$21.75

The wires recommended for use are the 2.50 mm gauge high tensile 'Tyeasy' plain wire and the 1.6 mm gauge high tensile reverse barbed wire.

Several types of high tensile wire are on the market. It is best to quote the breaking strain as well as the gauge of wire required when ordering.

### Tension

To ensure long life and effectiveness, strain the wire to the correct tension. Only wire strainers with a tension gauge can do this accurately. These are available from pastoral houses for about \$30.

When building a fence, strain both plain and barbed high tensile wire to 170 to 180 kg. This will give a final tension of about 140 kg after settling down. On hot days, strain to about 170 kg to allow for contraction in cold weather.

### Prefabricated or Plain

Plain wire fences, combined with barb, are recommended as, with the correct droppers, they are often as effective as, and cheaper than, prefabricated fencing.

Plain wires have the advantage of 'running' through the posts, thus transferring any 'shock' over the length of the fence. Because of this, plain wire fences can absorb a high impact, yet return to normal without damage. This does not apply to prefabricated netting which may cost up to 50% more.

If, for some reason, prefabricated fencing is preferred, it will perform satisfactorily using the suspension principle. However, post spacings must be limited to 20 m for best performance.

### Droppers

Droppers play an essential part in the fence. They keep the wires at the correct spacing from post to post.

Unfortunately, many droppers do not fulfill this function because they bend on impact, and often remain bent. A dropper must be reasonably rigid so that, when a beast puts pressure on one wire, the dropper transfers this pressure over the remaining wires in the fence.

At present, two droppers that are on the market can be recommended: a sawn, treated timber, and a light galvanized 'angle iron' type dropper, firmly secured by small wire 'nails'. Both of these are rigid and are also easily seen by stock, making the fence much more visible.

### Posts

Both steel and wooden posts have been used successfully in suspension fences. The choice of posts depends on individual circumstances. If steel posts are used, it may be better to order the 1.8 m type, which have 60 cm in the ground and still carry the top wire at 1.2 m.

### Designs and Costs

For controlling cattle, fences must be about 1.2 m high and should contain one or two barbed wires, not necessarily on the top but in the middle. Spacings need not be closer than 30 cm. For sheep, a fence can be lower;

wire spacing must be closer and barbs should be avoided. Graziers have successfully combined both these requirements in one fence at a material cost of \$125 per km.

A highly effective design for both cattle and sheep that is not extravagant is the six-wire fence with two barbs, made from 2.50 mm 'Tyeasy' plain and 1.6 mm high tensile reverse-twist barb.

The barbs are placed as the top wire and the third top wire. The top wire is 110 cm high, and wire spacings down from the top are 20, 20, 20, 15, 15 cm respectively, with the bottom wire 20 cm off the ground. Steel posts are 30 m apart, with three droppers evenly spaced per panel.

This fence has given good control of sheep and all classes of cattle, including bulls (controlled mating) and weaners. The approximate

cost of material (Brisbane prices late in 1973) was \$134 per km.

Some economy can be achieved with very little loss of efficiency by replacing the lower barbed wire with plain, thereby reducing the cost to \$125. The remaining barbed wire is then often placed as the second top wire.

A very effective, but more expensive fence, can be made with prefabricated materials (for example, 'hinge-lock' or 'Ringlock'). A common one is 6 x 40 cm ring lock, and one barbed and one plain wire on top, giving a total height of 112 cm. Steel posts are every 20 m. The approximate cost of material (Brisbane prices late in 1973) was \$181 per km.

With the obvious advantages of cost, ease of erection and effectiveness, it is not surprising that suspension fences are fast gaining popularity.

---

## Stud Cattle Exemption on Branding

UNDER certain conditions, stud cattle being offered for sale need not be branded with a horse and cattle brand.

This exemption was announced by the Minister for Primary Industries (Hon. V. B. Sullivan, M.L.A.).

He said that, from April 1, all cattle weighing more than 100 kg and being offered for sale must be branded with a registered horse and cattle brand.

To be exempted, stud cattle must be identified with a tattoo, or other brand, registered with the breed society of which the owner was a registered member.

Breed societies involved were: Australian Hereford Society Limited, Australian Jersey

Herd Society, Australian Red Sindhi Society, Australian Sahiwal Society, Charolais Society of Australasia, Guernsey Cattle Society of Australia (Queensland Branch), Murray Grey Beef Cattle Society, Queensland Society of Devon Cattle Breeders, and the Santa Gertrudis (Australia) Association.

These stud cattle were rarely branded with a registered horse and cattle brand.

However, cattle other than stud animals owned by members of these societies had to be branded as required.

Mr. Sullivan added that he would consider similar applications from other registered breed societies for exemption.



# Nematode Control in Banana Planting Material

by R. A. BROADLEY, Nematologist.

IN Queensland, rapid decline in banana plantings is often the result of nematodes, the most important of which is the burrowing nematode *Radopholus similis* (Cobb).

This pest, slightly less than 1 mm long and invisible to the naked eye, invades the roots and corms producing areas of reddish-black tissue. Fungi following in the path of the nematodes increase the rate of root breakdown. Heavily infested stools produce small bunches, give no worthwhile response to fertilizers and, because of their lack of healthy roots, are often uprooted in periods of wet, windy weather.

Although paring of planting material followed by treatment in hot water at 53 to 55°C for 20 minutes or in a 0.4% solution of DBCP (Nemagon\*, Fumazone\*) for 1 minute has been recommended for many years, the spread of the borrowing nematode into new areas continues.

The need for reducing further spread of the pest is becoming increasingly important. In north Queensland, the trend towards wider row spacing to facilitate the use of cultivators will undoubtedly contribute towards the more rapid spread of nematodes.

While the use of nematode-free planting material is only one facet of the problem, it is the basis of control.

A survey of current field practices and a study of the effects of treating planting material in hot water and/or chemicals on nematode control and subsequent plant vigour were recently completed by the author.

## Survey

Fifty-three plantations in the Mission Beach, Tully, Murray Upper and Kennedy areas of north Queensland were inspected. Data on type, method of selection and treatment of planting material were obtained from each in addition to root samples for the determination of nematode infestation. The results are summarized in Table 1.

TABLE 1  
NEMATODE CONTROL PRACTICES IN NORTH QUEENSLAND  
PLANTATIONS  
SURVEY RESULTS

	% farms
<b>A. Source of planting material:—</b>	
1. From nursery areas .. ..	4
2. From new plantings† .. ..	9
3. From old plantings†† .. ..	87
<b>B. Treatment of planting material:—</b>	
1. No treatment .. ..	6
2. Pared only .. ..	21
3. Pared and Hot water dipped .. ..	57
4. Pared and DBCP dipped .. ..	16
<b>C. Farms where burrowing nematode was recorded 86</b>	

Burrowing nematode was not found in seven plantings all of which were made on virgin land. The planting material was from nursery areas or plant crops on virgin land and had been pared, treated in hot water and then dipped in DBCP.

On most farms where burrowing nematode occurred, the main source of planting material was old plantings which were going out of production because of root rot. Experiments have shown that this type of material can be disinfected only by very heavy paring and hot water treatment, which lead to reduced vigour in the early life of the planting.

† Plant crop, first ratoon or healthy second ratoon from which suckers are removed for planting material.

†† Usually fourth or fifth ratoons which are about to be ploughed in because they are no longer economical.

### Experimental Studies

Trials were conducted to evaluate methods of disinfecting corms trimmed to a weight of 400 to 600 grams. Half were pared free of discoloured tissue indicative of burrowing nematode. Both lots were divided into eight groups, seven of which were treated in water at 55°C for 20 minutes and/or solutions of the non-volatile nematocides Nemacur\* and Mocap\* and the remainder left untreated. The plants were grown in sterilized sand for 12 weeks before being assessed for nematodes and vigour.

The main conclusions were:—

1. Hot water and chemical treatments do not eradicate nematodes unless the material is pared free of discoloured tissue before treatment.
2. Treatment of pared material in hot water or Nemacur will eradicate nematodes.

3. Plant vigour is reduced less by hot water than by Nemacur.

### Recommendations

1. Adopt paring followed by hot water treatment as routine procedure.
2. Establish nursery areas from treated material instead of relying on old plantations for planting material.

---

\* Registered Trade Names. The active constituents of the chemicals referred to in this paper are:—

DBCP (Nemagon, Fumazone).—1,2 dibromo-3-chloropropane.

Nemacur.—Ethyl-4(methylthio)-m-tolyl isopropyl-phosphoramidate.

Mocap.—O-ethyl S, S-dipropyl phosphorodithioate.

---

## Tick Fever Vaccine Price Rise

THE price of tick fever vaccines from the Department of Primary Industries were increased from July 1.

The higher prices were announced by the Minister for Primary Industries (Hon. V. B. Sullivan, M.L.A.).

Mr. Sullivan said that monovalent, or single, organism vaccine of *Babesia argentina*, *Babesia bigemina* or *Anaplasma centrale* is now 12c a dose with a minimum of \$2 (previously 10c with a freight charge and a \$1 minimum).

Bivalent, or multiple, organism vaccine, usually *Babesia argentina* and *Anaplasma*

*centrale*, is now 17c and a minimum of \$2 (previously 15c and freight and a \$1 minimum).

Although the freight charge had been absorbed in the interests of efficiency, a charge would be made for unusual costs, such as hire of a taxi for despatch of the vaccine or when advice of despatch required telegrams or telephone calls.

Mr. Sullivan said that the charges for single organism vaccines had not been changed since March 1965, and costs of production had increased markedly since then.



# Highworth, a New Lablab Cultivar

FARMERS growing lablab bean now have the choice of another cultivar, the newly-released Highworth.

Until its release, the only commercial cultivar of *Lablab purpureus* (formerly *Dolichos lablab*) available in Australia was Rongai.

Rongai has many advantages over other leguminous forage crops such as cowpea. These include freedom from pests and diseases and a long production season extending through autumn into winter. In addition, its relative independence of soil nitrogen for satisfactory growth and its ability to retain quality over a longer period put Rongai ahead of forage sorghums for feeding some classes of animals.

Because of the high seeding rate (25 kg per ha or more) required to give the best animal performance, together with the relatively high cost of the seed, establishment costs for Rongai lablab are high. This has often limited its use.

Seed production of Rongai is restricted to frost-free areas and its flowering and pod maturing habits can lead to some harvesting difficulties. These deficiencies prompted an examination of other lines of *Lablab purpureus*.

---

AUTHOR: J. H. WILDIN, Agrostologist.



*Its erect growth habit with the seedpods held well above the foliage facilitates mechanical seed harvesting of Highworth lablab.*



*Mechanical seed harvesting of Highworth lablab at the Brigalow Research Station.*

Consequently, a range of the most promising introductions was grown by the Queensland Department of Primary Industries at Parada Research Station in North Queensland and at the Brigalow Research Station in Central Queensland. At both centres, the outstanding introduction over several years was a dual purpose grain and forage type which has now been released under the cultivar name Highworth.

### **Origin**

Highworth has been derived from seed collected in August 1961 by Dr. D. Parbery (formerly of C.S.I.R.O.). Registered as

CPI 30212 *Dolichos lablab* var. *lignosus*, it came from the Agricultural Research Institute, Coimbatore, South India.

During 1961-62 it was grown under quarantine at Samford C.S.I.R.O. Research Station and distributed for testing in 1963. Material received by the Queensland Department of Primary Industries was given the accession number Q6059. After initial screening at the Parada and Brigalow Research Stations, it was further tested at the Brigalow Research Station, at Biloela and at the C.S.I.R.O. Narayen Research Station where its superiority to Rongai in this frequently frosty winter area was confirmed.

In September 1973, Highworth was approved for release by the Queensland Herbage Plant Liaison Committee. The name Highworth, while expressing value, was taken from a former station property at Theodore, portion of which is now included in the Brigalow Research Station.

### **Description**

Highworth lablab is a summer growing, herbaceous annual or short lived perennial with a growth habit influenced by time of planting. When established in spring or early summer, it has a twining habit similar to Rongai but later plantings grow erect. Generally, however, it is very similar in appearance to Rongai, except that there is a characteristic purplish band visible on the stems at the junction with the leaf stalk.

Highworth is readily distinguished from Rongai when flowering by its purple flowers in contrast with the white flowers of Rongai. There is also a colour difference in the seeds; in contrast with the light brown seeds of Rongai, the seeds of Highworth are black when fully mature although some brown seeds occur when the ripening process is hastened. There are 4 000 to 6 000 seeds to a kilogram.

Highworth flowers 3 to 4 weeks earlier than Rongai in North Queensland and up to 6 weeks earlier in Central Queensland. This enables it to set seed reliably before the onset of heavy frosts. It also carries its seed pods well above the main body of the foliage so that harvesting is easier. This can be seen in the





A volunteer seedling crop of Highworth lablab ready for grazing in December. The area was ploughed in September after a seed crop had been harvested in July.

TABLE 1

FEATURES WHICH DISTINGUISH HIGHWORTH FROM RONGAI

	Rongai	Highworth
Flowering ..	May-July (extending to September in moist frost-free areas)	April-early May
Flower colour ..	White .. ..	Purple
Seed colour ..	Light Brown ..	Black (some brown)
Stem colour ..	Uniformly green	Purplish band at junction with leaf stalk
Sub coastal Queensland Forage yield (rain-grown)	3 000-5 000 kg/ha	Similar to cv. Rongai but maximum yield attained earlier
Seed yield ..	Nil .. ..	1 000 kg/ha and reliable

illustrations. Flowering and pod maturing are also more uniform and there is little pod shattering.

### Cultivation and Performance

The soil and climatic requirements for vigorous growth are similar to those demanded by Rongai, and drought tolerance is at least as good. *Rhizobium* inoculation requirements are also similar (cowpea strain).

In sub-coastal regions of Central and Northern Queensland, forage yields early in the growing season may be higher than those of Rongai but the total season's yield is comparable. In frosty areas, the seed yield of Highworth is greater than that of Rongai. In sub-coastal Queensland where seed set of Rongai is very unreliable, seed yields of Highworth have consistently been better than 1 000



kg per ha. Under good growing conditions, as much as 2 000 kg per ha of seed have been harvested.

The performance of animals grazing Highworth at the Brigalow Research Station has been similar to those grazing Rongai. The main virtue of Highworth over Rongai is its reliably high seed yield over a wider range of environments. The early seeding does not appear to have shortened the grazing season greatly in these frosty areas.

In fact, very high daily liveweight gains have been recorded with steers grazing mature and ripening pods in June-July, a period when grazing animals normally lose weight on pasture.

The rapid early growth and erect habit make Highworth an excellent hay crop. A yield of 2.5 tonnes per ha has been produced 54 days after planting at the Brigalow Research Station, under rain-grown conditions. Seed and pods can also be conserved and used as a protein concentrate.

### Planting Recommendations

Planting times and seeding rates will vary according to the purpose for which the crop is grown.

FOR SEED PRODUCTION, planting should be between mid December and mid February. As the season advances, row spacings should be closed up and seeding rates increased accordingly. The following table developed from experiments at the Brigalow Research Station is a useful guide:—

TABLE 2

RECOMMENDATIONS FOR TIME OF PLANTING, ROW SPACINGS AND PLANTING RATES FOR HIGHWORTH FOR SEED PRODUCTION IN CENTRAL QUEENSLAND

Planting Time (approx.)	Row Spacings (cm) (conventional combines)	Plant Population (plants/ha approx.)	Seeding Rate (kg/ha approx.)
January 1 ..	160	45 000	10
7 ..	140	54 000	12
14 ..	120	63 000	14
21 ..	105	76 000	17
28 ..	90	94 000	21
February 4 ..	70	112 000	25
11 ..	50	135 000	30
18 ..	50	162 000	36

FOR GREEN FORAGE GRAZING, a planting rate of 30 kg per ha is recommended. This can be used for all plantings between late August and early March. Generally, these areas are ready for grazing about 8 weeks after planting and can be safely stocked at around 1.5 beasts per ha to use the green feed effectively. Stands can also be allowed to grow through to the mature pod stage before being grazed. If this is intended, the planting guidelines shown in Table 2 should be followed. Grazing can begin in mid May at a stocking rate no higher than 1.5 beasts per ha. This provides a useful finishing ration.

Highworth can also be used as a grazing supplement to low quality grass pastures in autumn and early winter.

FOR HAY PRODUCTION, it is desirable to plant 40 to 50 kg per ha seed in 18 cm rows, in late January to late February. These areas are usually ready to cut 8 to 12 weeks after planting.

### Conclusion

Highworth is a new cultivar of *Lablab* which will complement the existing Rongai. Its major difference is in earlier flowering and seed maturity which will permit seed production in areas where frosts begin too early for Rongai to mature its seed.

As a result, Highworth offers possibilities for use both as green forage and for seed production for forage.

Seed supplies are now being built up by a sub-committee of the Queensland Herbage Plants Liaison Committee based in Central Queensland. Commercial seed is expected to be available for planting in late 1974.



# ENDEAVOUR STYLO . . .

## Strengths and Weaknesses

ENDEAVOUR, a new stylo (*Stylosanthes guyanensis*) cultivar now under commercial assessment in the wet tropics of North Queensland has both strengths and weaknesses.

This cultivar was introduced about 7 years ago. Endeavour's strength is that it greatly outyields the standard cultivar Schofield. Its weakness is that it is more prone to grazing damage.

The pasture legume Schofield stylo, introduced in the 1930s, is now the standard stylo grown in coastal Queensland from Mackay to Cape York.

Early summer yields of Endeavour are greater than those of Schofield because Endeavour does not have a dormancy period after flowering, which is a marked feature of Schofield.

The real test of any pasture species is its performance under ordinary grazing management. For this reason, Endeavour and Schofield stylos were planted in a simple grazing comparison on a property in the Murray Upper area (between Cardwell and Tully). Mean annual rainfall is 2 400 mm.

Most of the fertile rain-forest soils at Murray Upper were cleared and planted to guinea grass-centro pastures up to 20 years ago. However, large areas of poor forest country also occur. Generally, this was not cleared because its carrying capacity was expected to be low. The comparison area was typical of this country.

The well-drained portions supported blue gum (*Eucalyptus tereticornis*), but shallow soils timbered with tea-tree (*Meleleuca quinquenervia*), and swamp mahogany (*Tristania suaveolens*) covered most of it.

### Grazing Comparison

Two adjoining 3.24 hectare paddocks were fenced, prepared for planting and fertilized with 500 kg/ha of zinc-fortified superphosphate. In December 1968, one paddock was sown with 2 kg/ha of Schofield stylo and 0.5 kg/ha of Hamil grass. In the other paddock, the Schofield stylo was replaced with Endeavour.

---

by P. D. MORTISS, Extension Officer.

---

Endeavour is one of several stylos collected in Mexico by Dr. B. Grof, formerly officer-in-charge of South Johnstone Research Station. It was introduced in 1965 as Q8558 and showed early promise in nursery plots. Subsequent performance led to its release by the Queensland Herbage Plant Liaison Committee in 1971.

The two paddocks were grazed lightly in the following dry season. From October 1969 to April 1971, they were stocked with three successive drafts of steers. The cattle were

weighed regularly during each grazing period. Stockings details and results are shown in the following table:—

TABLE 1  
LIVEWEIGHT PERFORMANCE  
(3 Drafts of Steers on 2 Pasture Plots, each 3.24 ha.)

Draft	Treatment	No. of head	Grazing Dates	Days	Mean Liveweight			Mean Gain	
					Initial kg/head	Final kg/head	kg/head/period	kg/head/day	kg/ha/period
1	Endeavour .. ..	4	30-9-69 to 13-3-70	164	311	449	138	0.84	170
	Schofield .. ..	4	13-3-70	..	309	451	142	0.87	175
2	Endeavour .. ..	6	13-3-70 to 28-8-70	168	313	417	104	0.62	193
	Schofield .. ..	4	28-8-70	..	313	413	100	0.59	123
3	Endeavour .. ..	6	30-9-70 to 30-4-71	212	326	418	92	0.43	206*
		+2	2-11-70 to 30-4-71	180	333	392	59	0.33	
		+3	1-12-70 to 30-4-71	150	'mowers'—not weighed				
	Schofield .. ..	4	30-9-70 to 30-4-71	212	327	438	111	0.52	137

\* This figure would be an under-estimate because it does not take into account the 'mowers'.

In the first draft, four head were run in each paddock, giving a stocking rate of a beast to 0.8 ha. For this grazing period (October 1969 to March 1970), there was no difference in liveweight gain between the two paddocks but the Endeavour paddock appeared to carry a much greater bulk of feed. Because of this, the number of head in the Endeavour paddock was raised to six in the next draft (it remained at four in the Schofield paddock). For this grazing period (March to August 1970), the gain per head was similar in both paddocks. However, the higher stocking rate in the Endeavour paddock resulted in about 60% more total gain over the Schofield paddock.

Both paddocks were then topdressed with 380 kg/ha of zinc-fortified superphosphate and spelled for a month. Regrowth of pasture

was good in both paddocks. The response of Hamil grass in the Endeavour paddock was especially obvious.

In October 1970, six head were put into the Endeavour paddock and four into the Schofield paddock. Because of the extremely vigorous growth in the Endeavour paddock, two more head were admitted 5 weeks later. In December, a further three head were added but these were 'mowers' to eat the surplus feed and were not weighed. Throughout the whole period, the number of head on the Schofield paddock remained at four.

The wet season of 1970-71 was unusually heavy and prolonged. Rain was almost continuous from late January until the end of



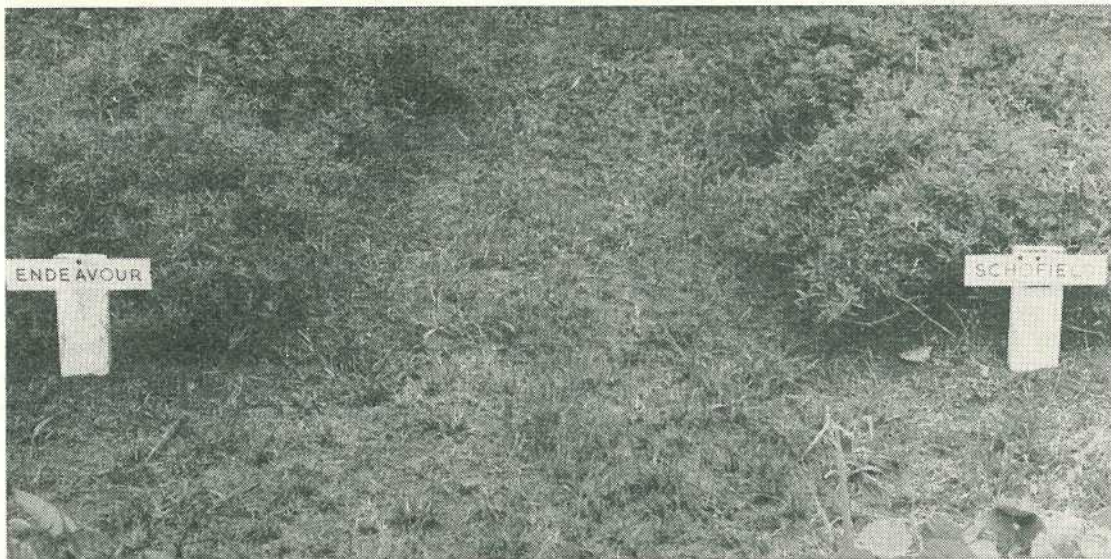

*Endeavour and Schofield stylos in nursery rows 2 weeks after cutting to the same height. Note the more vigorous regrowth of the Endeavour stylo.*

April and there was little sunlight. The continued rain resulted in heavy pugging of the pasture, especially in the Endeavour paddock where the stocking rate was the higher.

The steers were removed from both paddocks at the end of April. During the second half of the stocking period, they made very little gain. Those on the Endeavour paddock did not gain as much per head as those on the Schofield paddock, but once again the higher stocking rate gave a much higher total gain for the Endeavour paddock.

The paddocks were stocked again in June, 1971. Many of the Endeavour stylo plants had died as a result of trampling in wet weather. The cool, dry weather that followed, combined with the competition from Hamil grass, provided difficult conditions for legume germination and recovery.

Feed was so poor in the Endeavour paddock that steers continually escaped and, for this reason, the comparison was ended in October 1971. The draft was not ready for slaughter and had gained little in 140 days.

The paddocks were slashed in early summer to allow light to get to the legumes as the vigorous Hamil grass tended to smother them. Both pastures recovered well after rain and a good balance of grass and legume was restored.

### **Avoid Heavy Wet Season Grazing**

The results of the grazing comparison show that stylo pastures can be severely damaged if they are grazed too closely or are trampled too heavily. Stylo has a shrub-like growth habit with its growing points at the end of small branches. There are no growing points near the soil surface. Thus, heavy defoliation and damage to the growing points can result in very slow recovery and sometimes death to stylo plants.

The Endeavour stylo was far slower to recover from the grazing damage than the Schofield stylo. This was, in part, a result of the more severe damage suffered by the Endeavour with 11 beasts on the 3.24 ha.

Observation plots elsewhere also suggest that Endeavour stylo is more susceptible to grazing damage than Schofield. Plots at Ingham grazed during a wet February showed Endeavour to suffer more foliage damage and to be slower in recovery than Schofield. At Julatten, a combination of frost and grazing



resulted in severe damage to an Endeavour stand and its subsequent recovery was inferior to that of an adjoining Schofield stylo stand.

However, at Murray Upper, both paddocks recovered well during the next summer. The indications are that both stylos will continue to be productive if they are stocked moderately during heavy wet periods.

The results here justify the practice of experienced graziers who reduce stocking rates in the wet season. On several properties in the Murray Upper area which rely on buying and fattening stores, most of the cattle are sold off by late December. Many graziers have found that, in the wet season, heavy stocking severely damages the pasture and cattle make only small weight gains. This effect is greater on low-lying country.

The Schofield stylo in this comparison performed similarly to commercial stands in the district. It supported a beast to 0.8 ha at a

liveweight gain of 0.68 kg a day for at least 6 months. However, it appears that Endeavour stylo could carry approximately 1½ beasts per 0.8 ha gaining at the same rate for at least the same time.

The owner of the property has since cleared and sown several new areas to mixtures based on Endeavour stylo.

Another new stylo cultivar, Cook, has also shown superiority over Schofield. It has better growth in winter and spring than Endeavour and may extend the areas in which stylos can be grown in North Queensland.

I wish to thank Mr. M. Hibberd, formerly an officer of Cattle Husbandry Branch, for weighing the cattle and also the co-operating grazier.

---

## Vaccine for Marek's Disease

A vaccine now available is expected to cut poultry deaths from Marek's disease by 80%.

Mr. J. W. Evans, a Divisional Veterinary Officer in the Queensland Department of Primary Industries, said this at a meeting of Caboolture district poultry farmers.

The meeting, one of a number to be held in south-eastern Queensland, was organized by Mr. J. A. Gordon, Inspector in the Department's Veterinary Services Branch. About 30 farmers attended.

Mr. Evans said that Marek's disease was a major problem in the poultry industry. It produced small swellings consisting of aggregations of white blood cells, along the course of

the nerves. The swellings gradually crushed the structure of the nerve and destroyed its function. Birds also might have tumors form in the ovary and other organs.

The vaccine, developed from turkey herpes virus, would give the bird protection for its commercial laying life. The vaccine was injected when the bird was one day old.

Only one vaccine was available at present. A second vaccine, now undergoing trials, was expected to be released in the near future.

The vaccine cost about 3c a bird to which handling charges must be added.

Mr. Evans said the next development was likely to be a special vaccine for breeders.



# Virus Diseases of Maize

## Maize dwarf mosaic

MAIZE dwarf mosaic is the most important virus disease of maize in Queensland and is widespread in central and southern districts.

Crops of susceptible hybrids commonly have more than half of the plants infected.

The disease is characterized by leaf symptoms consisting of mosaic and ringspot patterns of chlorotic stripes between the veins. Ringspot patterns are generally produced on mildly reacting lines while conspicuous yellow stripes and mosaic patterns occur on more susceptible hybrids. In these more susceptible hybrids, severe stunting may result and yields are affected.

The causal virus, which is related to sugarcane mosaic virus, is carried over from season to season in infected Johnson grass (*Sorghum halepense*), from which it is spread to maize by several species of aphids.

The disease can be minimized, particularly in locations where a high incidence of the disease can normally be expected, by growing hybrids possessing resistance. Details of hybrids recommended for the various maize growing areas are published annually by the Department of Primary Industries before the season begins.

## Maize stripe

MAIZE stripe, caused by maize mosaic virus, is a widely distributed and common disease in North Queensland, but may also be found in southern areas.

While the incidence is not usually high, the disease has occasionally reached epidemic proportions.

First symptoms show up on young leaves as light specks. These elongate, broaden and fuse to form light-yellow, interrupted stripes parallel to the midribs of the leaves. The stripes, in turn, fuse into broad bands of yellow, or sometimes white, tissue radiating out from the leaf base parallel to the veins. Plants affected early in life are stunted, kinked and bleached with yields subsequently reduced.

The virus is transmitted from plant to plant by a small, brown leafhopper (*Perigrinus maidis*) which persists from season to season on volunteer maize plants, sorghum and sorghum-related grasses.

## Wallaby ear

WALLABY ear is a disease with virus-like symptoms resulting from the feeding of a leafhopper, *Cicadulina bimaculata*, on maize plants.

The disease is often prevalent on late crops on the coastal strip of Queensland.

Leaves of affected plants are dark-green, have a crinkly appearance, are rolled inwards and stand out stiffly at a sharp angle. A characteristic feature is the production of narrow, white outgrowths or galls on the secondary veins on the undersurfaces of the leaves. A plant affected early in life is stunted and ear development is poor.

Control of the disease is based on control of the insect vector with insecticides and avoidance of later plantings which are more likely to be heavily infested by leafhoppers.

— Plant Pathology Branch

Further information can be obtained from the nearest Plant Pathology office or by writing to the Director, Plant Pathology Branch, Department of Primary Industries, Meiers Road, Indooroopilly, Q., 4068.

# Diseases of Maize - 2



*Maize dwarf mosaic. Above: mosaic pattern. Right: ringspots.*

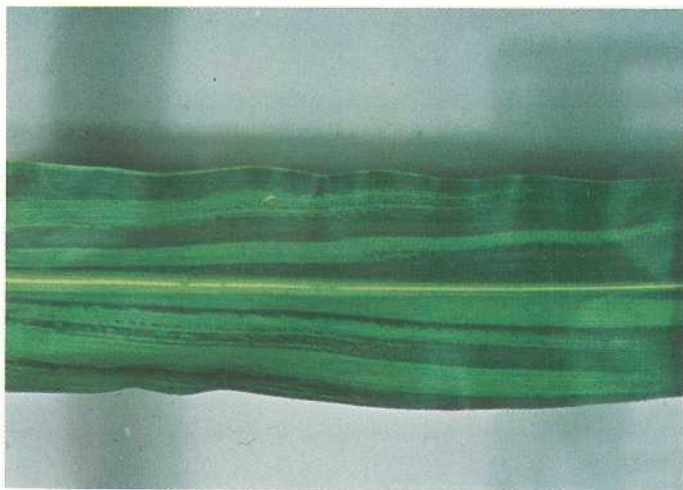

*Maize stripe*



*Wallaby ear (healthy plant in background).*



# Egg Quality Demands Care

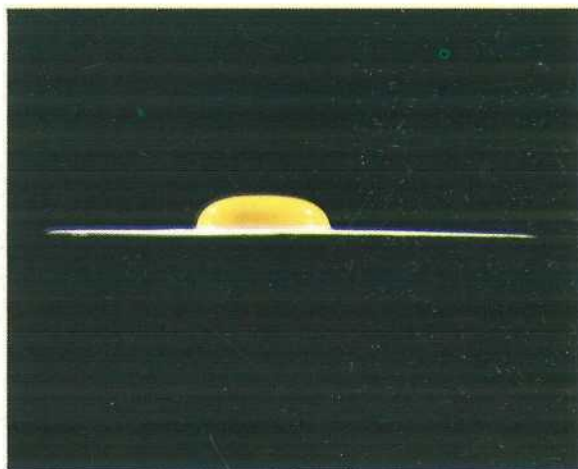
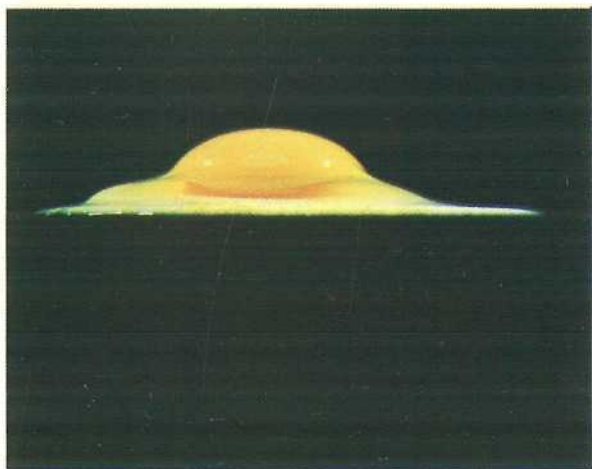
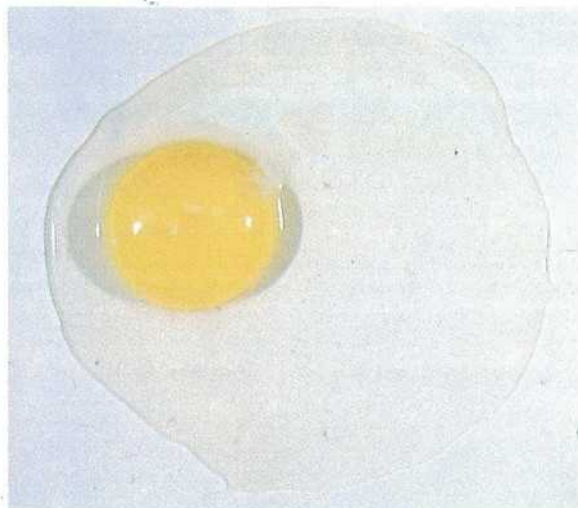
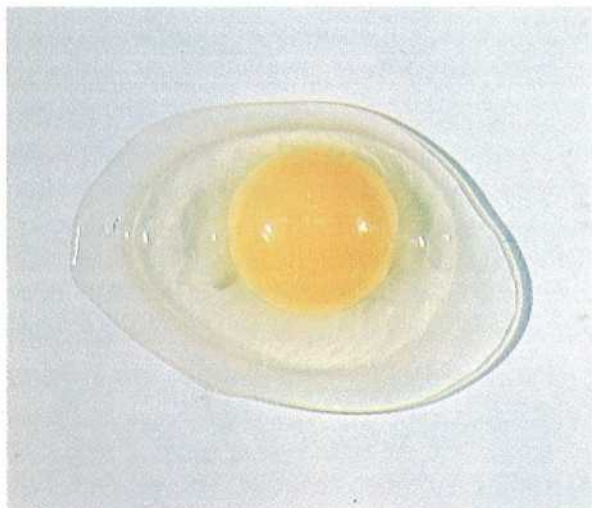

*Fresh egg — Yolk round, compact and erect, surrounded by very thick, dense albumen.*

*Stale egg — Yolk oblong, enlarged or flattened, surrounded by weak, watery albumen.*

# Egg Quality Demands Care

SIGNIFICANT improvements in egg quality can be brought about only through an integrated approach to the problem which should involve all stages of the marketing chain from the farmer to the consumer.

The main features to look for in a first quality egg are a strong, clean shell, a high proportion of firm to thin white, freedom from blood and meat spots, and a firm brightly coloured yolk. A strong shell means that the egg will be able to withstand normal handling and transport without being broken. Fresh eggs with plenty of firm white adhering closely to the yolk are more appetising when poached or fried and have a mild, pleasant flavour. Blood spots are unsightly and certainly not very appetising. The foaming property of a fresh first quality egg is superior to that of a stale egg which has a watery white.

From the time the egg is laid, its internal quality begins to decline. The most obvious physical changes that occur are the breakdown of the thick white to thin white and the swelling and increased fragility of the yolk. Flavour changes and loss of foaming properties also occur.

These changes can be speeded up or slowed down depending on the conditions under which the eggs are stored and handled while in the marketing chain from the farm to the consumer. Heat and time are the two most important factors linked with quality decline in eggs.

The responsibility for safeguarding egg quality must rest initially with the farmer. When the egg is laid, the temperature of its contents will be approximately the same as the body temperature of the hen, usually about 40 to 42°C. If the egg remains at this temperature, the interior quality will rapidly decline. The farmer should see that the eggs are collected at least twice a day and cooled as soon as possible. A storage temperature between 13 and 16°C is most desirable. However, higher storage temperatures may be warranted in very humid weather to minimize condensation of moisture on the eggs following removal from storage. Measures taken to safeguard quality must be extended beyond the farm gate. Transport should be as swift as possible and under cool conditions.

Because eggs may remain in the retailer's care for up to 2 weeks after grading, it is obvious that storage and handling conditions for eggs in retail stores may well have a greater effect on egg quality than factors at the farm level.

Eggs that may be first quality when delivered to a retail store are not likely to be first quality after 14 days' storage and display at room temperatures in summer. If eggs are held at 13 to 16°C during this period, much of the quality loss can be prevented.

The introduction of refrigerated egg sales cabinets will help to prevent much of the quality loss at the retail level. If such facilities are not available, frequent purchase of stocks and rapid turnover will assist in reducing quality decline at the retail level. Eggs should always be displayed in the coolest part of the store away from direct sunlight.

— D.J. COMPTON, Poultry Adviser





# Bean Seed Industry in the Dry Tropics

BEAN seed production began in the Lower Burdekin Valley in north Queensland in 1957. The seed was mainly produced in the Clare and Millaroo areas to supply the needs of the green bean industry in this State.

Over the years production has expanded considerably from 81 hectares planted in 1957 to 1 229 hectares in 1973.

The industry has also been extended to the Bowen district, and more recently to the Proserpine area, where 65 ha were sown in 1973 for seed multiplication. Production from these northern areas satisfies the needs of Queensland and that of most of Australia for seed in the processing, fresh market, and culinary bean industries.

---

by R. F. LOVELADY, District Adviser in Horticulture.

---

Total seed production in 1973 was approximately 1 587 500 kilograms returning to growers \$550 000.

The climate in the Burdekin, Bowen and Proserpine areas during the cooler months of the year is suitable for bean seed production and there is ample water available for irrigation. During the autumn-spring growing period, mild weather with very little rainfall normally prevails and frosts are rare.

## Crop Management

Planting begins in early April and continues until the end of June. The land used for seed production is flat and comprises sandy loams and sandy silt loams but, with the expansion of the industry, crops are now grown on some of the heavier soil types.

Seed is planted at the rate of 56 to 67 kg per ha in single rows 77 cm to 92 cm apart. Plant spacing in the row is 8 cm. The high plant population usually gives uniform cropping, pod ripening, and normally satisfactory yields.

In the Burdekin Valley, fertilizer is applied as a basal dressing at the time of planting, and again as a side-dressing 10 to 14 days after seed emergence. In the Bowen district, the seed crops are grown on basal fertilizer only. The total amount of fertilizer applied varies with the soil type, but is usually about 100 kg per ha of nitrogen and 25 kg per ha of phosphorus.

## Irrigation

All crops in the Burdekin district and at Bowen are furrow irrigated, and from three to six irrigations per planting are usually applied.

In the Clare and Millaroo areas, water is supplied through irrigation channels by the Irrigation and Water Supply Commission.

In the other producing areas, water is pumped direct from river sources or from underground supplies.

## Weedicides

Grasses and broad-leaved weeds are controlled by either cultivation or herbicides. The use of chemicals to control weeds is increasing. EPTC (Eptam) at 7 litres/ha applied before planting and incorporated immediately into the soil at a depth of 5 to 8 cm has given good control of most weeds.

## Varieties

More than 40 varieties of beans were grown in the dry tropics in 1973.

At present the main varieties are—Processing: Apollo and Gallatin 50. Fresh market: Redlands Pioneer and Redlands Greenleaf. Culinary: Borlotti and Cannellini.

## Harvesting

Bean seed is ready to harvest 14 to 16 weeks after planting and the bulk of the crop is mechanically harvested.

The plants are cut when about 80% of the pods have reached maximum development. Two or four rows of plants are cut in a single sweep, at or below ground level, and left to dry for about 7 days.

Four to six rows are then brought together with a windrowing machine. The seed is threshed within 7 to 14 days of windrowing when it still has a high moisture content. If the seed becomes too dry, losses through broken and shattered seed can be high.

Yields average about 560 kg per ha of clean seed, though yields of 900 to 1360 kg per ha of seed have been obtained.

## Legislation

Four categories of bean seed are produced under the Queensland bean seed schemes. They are: Certified Seed, Special Mother Seed in Stages A and B, and Approved Seed.

Certified bean seed can be produced only from Certified seed or from Stage B Special Mother Seed. Certified seed is warranted as free from the seed-borne diseases halo blight, common bacterial blight, and anthracnose. A crop registered for certification is inspected at least twice in the field for freedom from these diseases. Harvesting, cleaning, and bagging are carried out under the supervision of an officer of the Department of Primary Industries.

Queensland Certified bean seed is primarily reserved for the production of further Certified seed or Approved seed. Occasionally, however, the release of surplus Certified seed to

the edible bean industry is approved by the Department of Primary Industries.

Before a new bean variety qualifies for certification status, it must pass through two generations of disease-freedom as Special Mother Seed in Stages A and B. The crop is grown under similar conditions to those prescribed for Certified seed production.

Approved seed can be produced only from Certified seed. The crop is inspected in the field and there must be no prohibited seed-borne diseases in the crop when it is harvested.

However, if plants infected with halo blight, common bacterial blight and anthracnose do occur in the growing crop and make up less than 0.1% of the total plant population and the infected plants can be removed completely at one roguing, then the crop is accepted as a source of Approved seed.

Approved bean seed is intended for use by commercial growers of fresh market beans, processing beans, and culinary beans.

## Burdekin Quarantine Area

In 1967, the Burdekin Bean Seed Quarantine Area was proclaimed. This action followed outbreaks of seed-borne bean diseases in the Lower Burdekin which coincided with the use of imported bean seed in the district.

The purpose of declaring the quarantine was to protect the industry by allowing only seed known to be free from bacterial diseases into the proclaimed area. All seed used within the area must, therefore, be in categories or classifications approved by the Queensland Department of Primary Industries.

There are no restrictions on planting beans for seed production outside the Burdekin Bean Seed Quarantine Area, other than isolation and other provisions which apply to areas registered with the Department of Primary Industries for the production of Certified, Special Mother, and Approved Bean Seed.

Since 1967, there have been no recorded instances of bacterial seed-borne diseases occurring in bean crops in the Lower Burdekin as a whole, or in bean seed crops at Bowen and Proserpine.



# Nearly 100 Years of Beekeeping at Rockhampton

As far as can be determined, beekeeping dates back to 1883 in the Rockhampton district.

by C. ROFF, Chief Adviser in Apiculture.

In fact, an original apiary site established at Coowonga, 30 km from Rockhampton, is still being used, and has been occupied continuously with hives since 1883, and probably earlier.

Edwin Whiteley was the second settler in the Emu Park area and, from about 1880 onwards, his two sons David and Tom developed an apiary at Coowonga, ultimately establishing 80 hives. Over the years, honeybees and beekeeping equipment were imported by them from A. I. Root Company, Medina, Ohio, U.S.A. and some of it is in use still. The honey-house used today was built about 90 years ago.

During 1900, Herbert Whiting, brother-in-law to David and Tom, purchased the apiary and expanded considerably. He established apiaries at Emu Park, Coorooman and a second one at Coowonga. At peak, he was managing about 200 colonies and transported equipment and honey between the apiaries by a two-horse wagonette.

The honey produced by D. and T. Whiteley and H. Whiting was sold in Rockhampton to merchants, and in the open marketplace at East Lane.



A honey label used by Edwin Whiteley about 1883.

Herbert Whiting died in 1927 and one of his sons, Robert, worked the bees for his mother until 1933; then another brother, George Herbert, and himself became partner owners of the hives. Between that year and 1946, the Whiting



*The original Coowonga apiary site, established about 1883, is 30 km from Rockhampton. This apiary is still being worked.*

Brothers merged 500 colonies and established additional apiaries at nearby Tungamull, Emu Park, and Redden Farm.

All the apiaries are permanent sites and cover nectar and pollen producing trees such as narrow-leaf ironbark, blue gum, river mangrove, stringybark, lemon-scented gum and scrub box.

In 1946, drought reduced the numbers of hives. Considerable losses were again experienced in 1949, following extensive damage to bee forage trees by a severe cyclone. Their beekeeping has never

recovered to pre 1946 levels and recently the two brothers retired from beekeeping. The original Coowonga apiary is being operated by the new owner on that site.

Between 1933 and 1946, the honey produced by G. H. and R. Whiting was sold locally in Rockhampton and exported by ship to Townsville, Mackay, Ayr, Gladstone and Brisbane.

I am greatly appreciative of Messrs. G. H. and R. Whiting for making historical family information available and allowing me to compile it for publication.







*These scattered trees were left as shade but were killed by the fire and are now a problem in aerial spraying for sucker control.*

# Brigalow to Pasture in the North-2

by P. V. BACK, Botany Branch.

## REGROWTH CONTROL

Some regrowth control is necessary in nearly all areas of developed brigalow country. The type, density, and economic significance of the regrowth, as well as the control measures needed, vary with each situation.

### Brigalow Regrowth

1. **YOUNG REGROWTH.** Brigalow suckers in the first season after the initial scrub burn are the easiest and most economical to control. They are growing vigorously and root reserves are depleted, making them very susceptible to chemical treatment.

Suckers should not be sprayed sooner than 4 to 5 months after the scrub burn. This time lapse allows all the new regrowth to emerge so that fresh suckers do not appear after spraying. An estimation of emergence can be made by inspecting the area for the little 'eruptions' of soil that indicate the imminent appearance of a sucker.

It is advisable to inspect the burnt area thoroughly 3 months after the fire to see what number of suckers is appearing. At this stage, about 80% of the suckers are through and a decision can be made on whether control spraying should be undertaken. This allows about 4 to 8 weeks to organize spraying contractors or get property equipment ready.

Shielding of suckers by the grass can be a problem when spraying at this stage. If this grass shielding is so severe that it prevents penetration of the spray onto the suckers, then the spraying should be postponed. It can be



carried out during the following late spring or early summer, after a good fall of rain. This allows the pasture to be grazed down during the winter to expose the suckers. Grazing in the first summer to reduce shielding is not recommended as this may harm the young sown pasture plants.

The chemical used for spraying brigalow regrowth is 2,4,5-T ester and the rate is 700 to 1 120 g acid equivalent per hectare in diesel distillate as the carrier. Aerial application is economical on larger areas and has the advantage of covering the ground a lot faster than ground equipment. The rate usually used by aerial operators is 700 g a.e. of 2,4,5-T ester in 28.1 litres diesel distillate per hectare. The cost for this operation (aerial spraying) is between \$5.40 and \$6.40 per hectare all inclusive (chemical, distillate, and flying) and kills of 80 to 95% can be expected.

Sucker control spraying can be carried out in the first season any time from 4 to 5 months after the burn until the first frost in winter. If it is impossible to spray during this period, then the next best time is following the first rains the next summer.

It must be remembered that spraying these young suckers is the **cheapest and most effective** means of control. As the suckers get older, they are harder and more costly to kill so every effort must be made to get this early spraying done.

2. OLD REGROWTH. The older a brigalow sucker gets, the more difficult it is to control. For this reason, a single spraying of older brigalow suckers is of limited effect; the usual kill is about 50 to 60%.

Respraying then becomes necessary. To obtain the best results, a second spray should be applied 10 to 12 months after the initial spraying.

Spraying should be carried out only under conditions of high soil moisture. When this occurs, the suckers are most susceptible to the chemical 2,4,5-T. These conditions are usually encountered between late December and early April, with the earlier period usually giving the most reliable results (that is, December to February).

Often, after the first spraying, dead leaves and twigs build up around the base of the suckers. This material shields the surviving lower leaves and makes it impossible to get the spray through to them. When this occurs, it is advisable to burn the area before the second spray. The second spray should not be applied until at least 4 to 5 months after the burn. If the season is very dry then it is an advantage to delay spraying until conditions are better (usually the following summer).

Where older suckers are fairly sparse and the pasture is still in good condition, it is often helpful to burn the pasture and suckers before spraying. This grass burn knocks the suckers down to ground level and the new regrowth is easier to spray. Here again, spraying should be delayed 4 to 5 months after the burn.

It is usually necessary to graze the grass down before spraying to avoid shielding. The cattle should be removed at least a fortnight before any chemical treatment to let any damaged suckers recover. Using this technique, only one spraying may be necessary to control the suckers.

Success depends on making sure that all the suckers have emerged when spraying begins. Under very dry conditions, this may take 6 months or longer. If conditions are not suitable when all the suckers come through, then delay spraying until things improve.

Spraying for control of old brigalow suckers is only as good as the pasture that results. In situations where the regrowth is so thick, that all, or most, of the improved pasture has gone, then a native grass pasture is the best that can be expected when the suckers are removed. Under these conditions, it may be necessary to cultivate the area to produce a seedbed for replanting the sown pasture.

3. PLOUGHING. Ploughing is the most effective means of controlling most regrowth. Notable exceptions are limebush, bitter bark, whitewood, and Leichhardt bean. It is also the most expensive commercially-used treatment. When crops are grown, then productivity can offset the high costs involved. Unfortunately, a high risk is involved with cropping in the northern brigalow areas. Added to this is the problem that only relatively small areas can be cultivated at one



time. This problem is further compounded in that suckery country must be cropped for at least three consecutive years to get a satisfactory control.

In badly suckered paddocks in the northern areas, a compromise may be necessary to reintroduce improved pasture species. This could be in the form of stick-raking roughly, deep disc ploughing, sowing the pasture and then spraying the regrowth. The single heavy ploughing will remove most of the other woody species and the brigalow will be reduced to ground level. With the brigalow like this, spraying is effective and a single spray should clean up most of the remaining suckers.

Using this technique, large areas can be handled fairly quickly by contractors. The paddock is then in a condition suitable for

ploughing at any time in the future for pasture renovation, cropping, or any further woody regrowth control.

A single deep disc ploughing under conditions of good soil moisture and vigorous plant growth can give a 60% reduction in sucker numbers. Two ploughings spaced 16 weeks apart under good conditions can give an 80 to 90% kill. This double ploughing, even though very effective, is also very expensive, and is warranted only when the suckers are very big and the first ploughing does not reduce all the original suckers to ground level. Good pasture establishment is usually achieved on these prepared seedbeds.

Where repeated ploughing is necessary to knock the big suckers down, a single forage or cash crop should be considered. The crop is

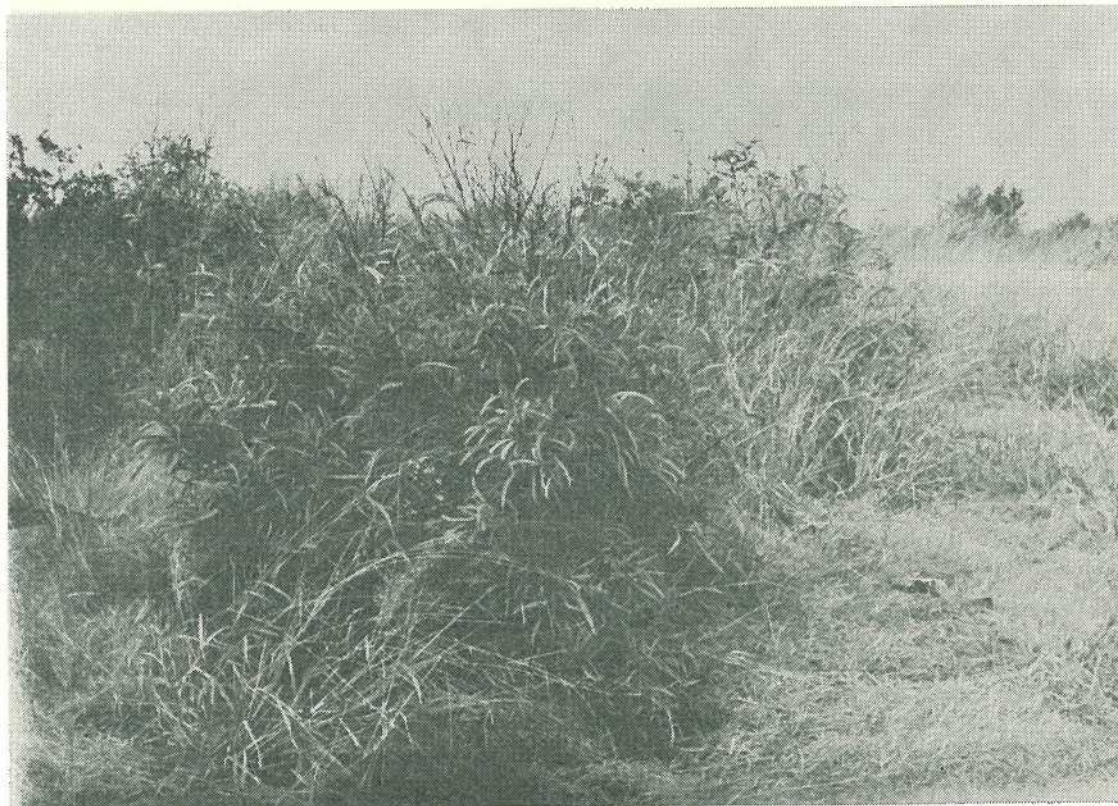

*Four-year-old suckers.*



grown only once and is undersown with pasture at the time of planting. After the crop has been harvested by grazing or heading, the area can be sprayed to kill any suckers remaining. When undersowing a crop with pasture, it is advisable to reduce the seeding rate for the crop. This enables the pasture seedlings to establish under the crop.

Another method of pasture establishment is to plough the area lightly after the crop is harvested and sow the pasture into this seed-bed. Either method can be successful and a good stand of improved pasture is usually established. With the latter method, spraying must be delayed at least 4 to 5 months after the last ploughing to allow the new suckers to emerge. Spraying should be carried out only under good conditions of soil moisture.

## General

Many variations of the methods described can be used successfully. If there is any doubt about the best line of attack to take, the local Department of Primary Industries adviser is available to discuss the matter.

When spraying brigalow suckers, it is necessary to remember a couple of points:—

- Avoid unnecessary drift. Never aerial spray or mist suckers in a wind stronger than 4 to 5 knots (wind felt on face, leaves rustle, ordinary wind vane moved by wind)
- Spray in the early morning and late afternoon only. As the temperature increases during the day, evaporation losses are increased tremendously. It is best to spray only when conditions are cool and calm.

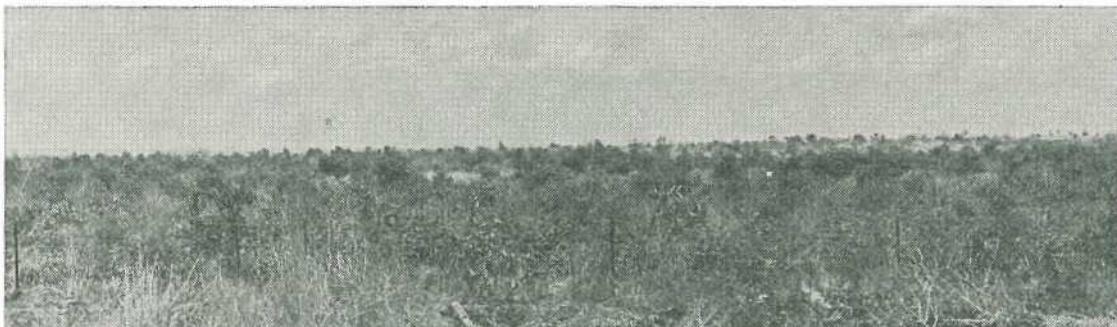

*Three-year-old suckers. This area should have been treated before it reached this stage.*

- Accurately mark out any spraying operation. If this is not done, areas are missed and have to be resprayed later. Aeroplanes or ground equipment can be only as accurate as the markers allow.
- The wetter the better is a good guide when spraying brigalow suckers.
- Measure out chemicals and distillate accurately and check application rates regularly. Never use tins of old or suspect chemicals. Keep the risk of drift in mind and be careful not to damage nearby crops, pastures (legume based), ornamentals, or other susceptible plants. (Most broadleaf plants are susceptible to 2,4,5-T in varying degrees.)
- Ploughing 10 cm or more deep gives the most reliable control. Shallower ploughing, even over a number of years, may not be sufficient to kill out the brigalow suckers. This shallow cultivation may be why, in southern areas, suckers still prevail in old developments after many years' cropping. Brigalow suckers can be controlled economically and efficiently. The main thing to remember is that they must never be allowed to grow unchecked so that they reach a stage where the pasture is ruined and a very costly reclamation programme is needed. The younger the suckers are treated, the easier and more efficient are the control measures. Always plan brigalow development, then fewer failures will occur.



# Four Hovea Species

by BERYL A. LEBLER, Senior Botanist.

MANY of our native plants were named by Robert Brown, the British botanist who accompanied Flinders to Australia in 1801-1803.

In 1812 he used the name *Hovea* for two shrubs with purple, pea-shaped flowers native to Australia and cultivated in the Royal Botanic Gardens at Kew. In doing this, he honoured a Polish botanist, Anton Hove.

Hoveas are found only in Australia, and differ from other native peas in the colour of their flowers, their short, turgid pods, and in having their staminal filaments united into a tube which is split on the upper side. They are always shrubs, and vary in height from small plants 30 to 60 cm to large branching bushes as tall as 2.5 to 3 m.

The leaves are always simple and alternate. They are glabrous on the upper surface; their lower surface is usually hairy. The Queensland hoveas always have leaves with entire margins, but in other States some hoveas have leaves with prickly teeth on the margins. Some even end in a pungent point.

All hovea flowers are some shade of blue, mauve, violet or purple. The flowers are either solitary in the axils of the leaves or are clustered in short axillary racemes. Individual flowers have the typical pea-flower shape and formation, with staminal filaments united into a sheath which is split along the upper side. The pod is turgid, either sessile or stalked, and is ovoid in shape, or very obliquely globular.

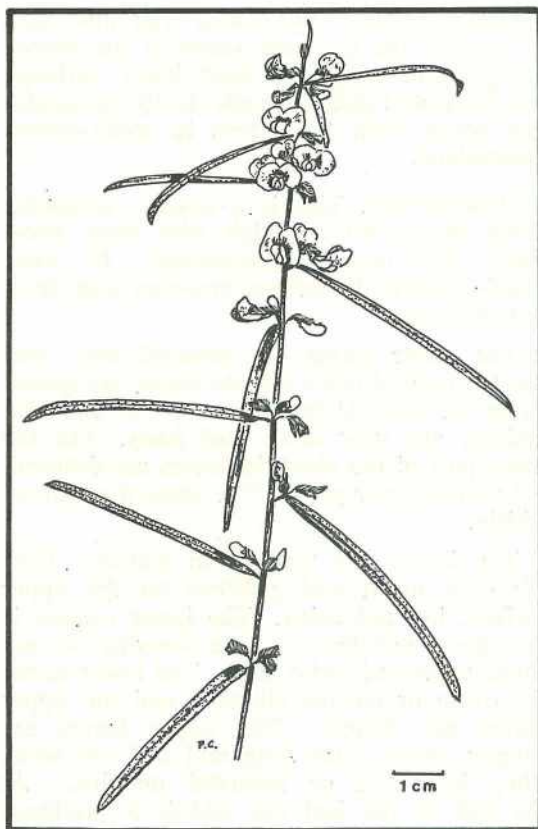

Common hovea (*Hovea heterophylla*).

There are other native pea-flowers besides *Hovea* with purple flowers. One is a wiry vine or twining sub-shrub (*Hardenbergia violacea*) and the other (*Mirbelia rubiifolia*) has leaves which are usually in whorls of three, and has stamens which are free from one another.

In south-eastern Queensland, four species of *Hovea* are found: *Hovea heterophylla*, *H. longifolia*, *H. acutifolia* and *H. pannosa*.

## Common Hovea

COMMON HOVEA (*Hovea heterophylla*). Two Greek words, *heteros* meaning different and *phyllon* meaning a leaf are combined to form the specific epithet for this plant. It refers to the different shapes and sizes of leaves, which can often be found on the same plant.

**DISTINGUISHING FEATURES.** The low habit of growth, the size and shape of the leaves, the greenish colour of their lower surfaces, and the almost glabrous pods clearly distinguish this hovea from the others in south-eastern Queensland.

**DESCRIPTION.** This is a slender, straggling shrub 60 to 90 cm high with erect stems which are usually unbranched. In some plants, several decumbent branches arise from ground level.

The terete stems are covered with very short appressed hairs, and the leaves are spaced along the stem at intervals of 1.25 cm. The petioles are very short and hairy. On the lower part of the plant the leaves are deflexed, but on the upper parts of the stems they spread widely.

The leaves are leathery in texture. They are dark green and glabrous on the upper surface, but not shiny. The lower surface is grey-green and has a sparse covering of very short, appressed white hairs. The lower leaves are ovate or narrow elliptical and the upper leaves are linear. The upper leaves are usually about 5 cm long and 0.3 cm wide. They have flat or recurved margins. At the end of the leaf the midrib is produced into a downward-curving mucro less than 0.1 cm long. The veins are sunken on the upper surface of the leaves and slightly raised, but concealed in the hairy covering on the lower surface.

The flowers are similar in colour to the purple form of the commonly cultivated aster, seen in many gardens in summer. They are usually found in pairs in the axils of the leaves. They have very short pedicels and the flowers point outwards, one on each side of the stem. In some plants, there is only a single flower in the leaf axil, but sometimes there are three flowers.

Each flower is about 0.6 cm long and has a calyx 0.5 cm long. Dense appressed grey hairs cover the calyx, the three lower lobes of which are long and pointed. The two upper lobes are joined for almost their whole length to form an emarginate lip 0.2 cm long and as wide as it is long. The spreading reflexed standard is emarginate and is more than 0.6 cm wide.

Most of the standard is aster purple. At the base is a pale yellowish-green patch. This is outlined by a darker purple arc with purple lines radiating from its outer margin towards the edge of the standard. The narrow wings are deeper in colour and project beyond the standard, flaring out away from the very short and narrow keel. This can be seen only from the end.

The sessile pod is either completely glabrous or is slightly pubescent with scattered appressed hairs. Very rarely, plants with white flowers are found.

**FLOWERING TIME.** From midwinter to spring.

**HABITAT.** This plant grows on sandy or stony soils. In Queensland, it is usually found among grasses in open eucalyptus forests in such localities as the Glasshouse Mountains or the hillsides at Chermside and Mt. Gravatt. It also grows on the banks of lagoons in wallum country and on the offshore islands in Moreton Bay.

**DISTRIBUTION.** It is found in all the eastern States to as far north as the Blackdown Tableland in Central Queensland.

### **Long-leaf Hovea**

**LONG-LEAF HOVEA** (*Hovea longifolia*). The specific epithet for this plant is a Latin word which means having long leaves.

**DISTINGUISHED FEATURES.** The leaf shape and size, the close tomentum on the lower surfaces of the leaves, and the tomentose pods clearly distinguish this plant from the other hoveas.

**DESCRIPTION.** It is an erect spreading shrub which can be as tall as 5 m but is often much smaller. The firm-textured leaves are dark green and shiny on the upper surface and much paler grey-green beneath, with a prominent brownish midrib raised on the lower surface. The leaf margins are very slightly revolute.

Different forms of this plant are found throughout Queensland, with leaves which vary in size from almost 7.5 cm long and just under 1 cm wide to leaves half that size. In all the forms, the leaves have blunt, rounded leaf tips with leaf bases the same shape as the tips.



The leaves spread widely from the stems and the leaf blades are all more or less in the same plane.

All parts of the plant are hairy except the upper surfaces of the leaves and the corollas. On the petioles and the midrib on the lower surface of the leaf, the pubescence consists of short, crinkly rusty hairs. The lower surface of the leaf is covered by dense crinkly, hairs which can be rubbed off easily. A mixture of brown hairs and white hairs is found on the pedicels and calyces. Sometimes a sprinkling of minute, crinkly grey hairs can be found on the sunken midrib on the otherwise glabrous upper surface of the leaf. A network of veins can be seen as paler green lines but these veins are neither sunken nor raised above the surface.

The flowers are in the axils of the leaves. Just as there is variation in leaf size, so there is also great variation in the inflorescences. The reddish-lilac flowers can be solitary or in pairs, or arranged in short racemes of from two or three flowers to as many as seven.

Individual flowers are 0.6 cm long, with the calyx half that length. The reflexed emarginate standard is 0.9 cm wide and 0.6 cm deep. It has a prominent clear green patch at the base and this is bordered by a purple line with purple veins running from it part way to the margin. The wings project out beyond the standard 0.3 cm. The wings curve outwards from the keel and are 0.6 cm long and 0.3 cm wide. The keel is much shorter and narrower and is not seen unless the wings are removed. It is dark purple at the tip. The flowers do not turn all in the one direction. In some flowers the notch on the standard points towards the stem, on others it points downwards.

The pod is swollen, its base enclosed by the rusty brown, persistent calyx. It is black, almost 1.5 cm long, less than 1 cm deep, and half as thick. The mature pod does not look as black as most of the other species because of the sparse covering of short, curly, rusty hairs. The remnant of the short style is straight. Two dark, olive green to black seeds about 0.5 cm long and 0.3 cm deep are inside the pod.

**FLOWERING TIME.** Winter to early spring.

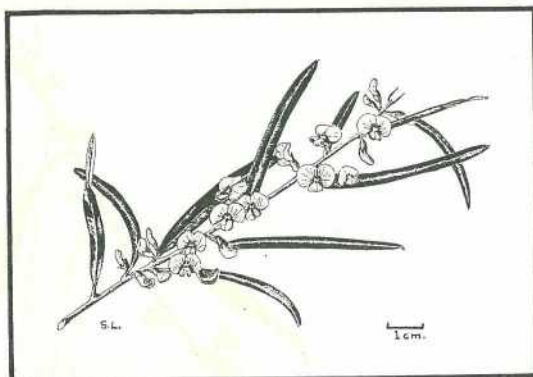

Long-leaf hovea (*Hovea longitolia*).

**HABITAT.** Usually it grows in shallow rocky soils in open eucalyptus forests, but it is also common on sandstone soils or ridges. It has been found in peaty soil near a creek on one of the offshore islands, and in open areas on the edges of light rain-forest.

**DISTRIBUTION.** It is the most widely distributed hovea in Australia and is found in all the States except Western Australia. In Queensland, it is found as far north as Cooktown and as far west as the Carnarvon National Park in Central Queensland.

**GENERAL REMARKS.** This is one of the most attractive and most floriferous native shrubs I have seen. The shiny, dark green leaves make a perfect background for the vivid flowers. This striking plant is now being cultivated and has possibilities for use on embankments along our new freeways.

### Pointed-leaf Hovea

**POINTED-LEAF HOVEA** (*Hovea acutifolia*). The specific epithet for this plant is a combination of Latin words meaning 'with pointed leaves'. It describes the shape of the leaves.

**DISTINGUISHING CHARACTERS.** The shape of the leaves alone is sufficient to distinguish this plant.

**DESCRIPTION.** It is a spreading shrub up to 1.8 m high, with numerous branched stems which are densely covered with short, brown, spreading hairs. The widely spreading leaves can be 8.8 cm long and 1.8 cm wide. They

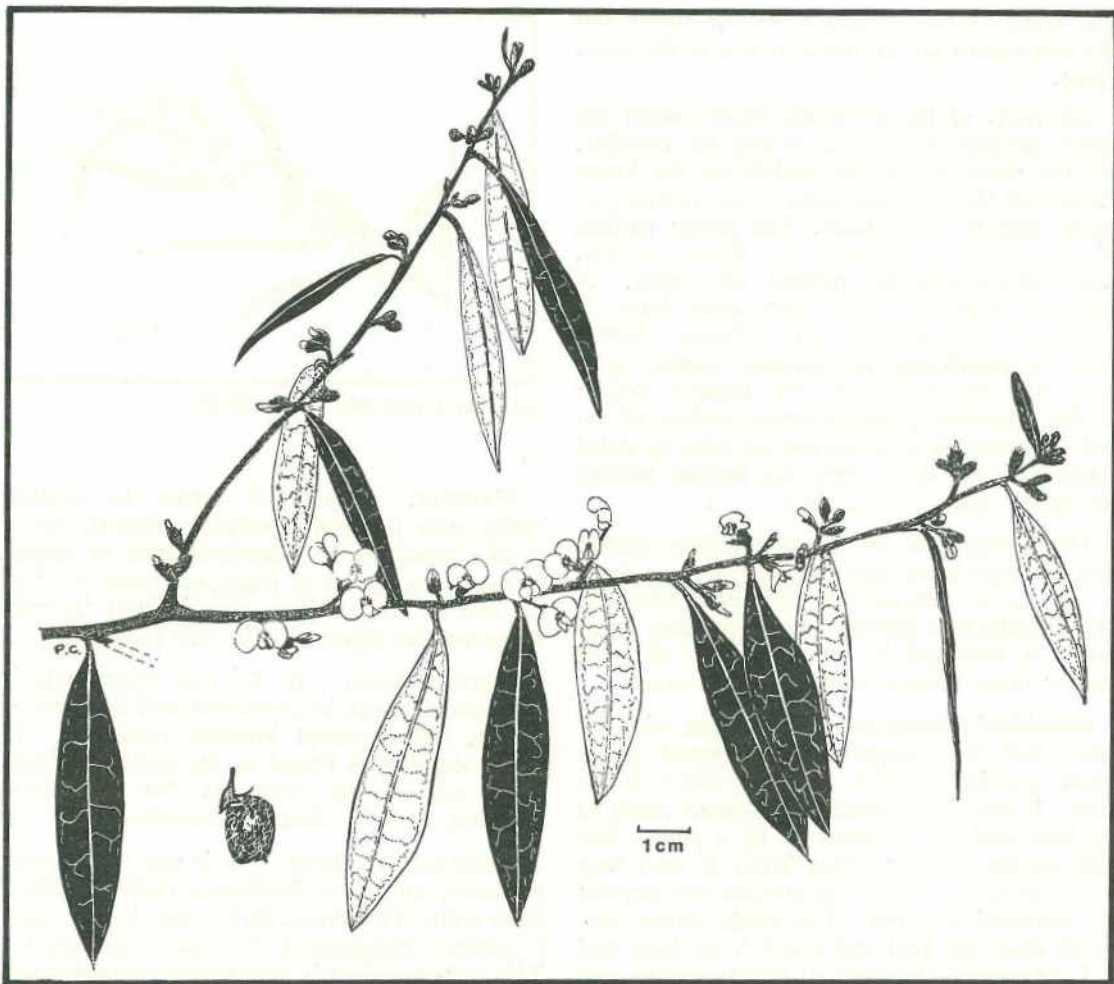

Pointed-leaf hovea (*Hovea acutifolia*).

are broadest at the middle, tapered to a narrow rounded base and have a pointed tip. The elliptical-oblong leaves are dark, glossy green on the upper surface and much paler beneath. Often the covering of long hairs on the lower surface of the leaf is so thick that the colour appears to be brown rather than green.

As many as four flowers can be grouped in little bunches in the axils of the leaves, not only near the ends of the branches but also all the way down the stems. The pedicels are about 0.25 cm long and, like the calyx, are densely covered with short, brown hairs

mixed with long, shaggy, white ones. The calyx is about twice the length of the pedicel and the two upper lobes are at least twice as broad as the three pointed lower lobes. The upper lobes are joined together for most of their length to form a lip in which the inner edges of the free part are curved and the outer edges are straight.

The spreading, reflexed, emarginate standard is just under 1.25 cm wide and twice as wide as it is long. Most of the standard is a deep amethyst-violet colour. At the base of the standard is a small green patch. This is bordered by a much deeper shade of violet, and the wings and keel are a colour midway



between these two shades. The standard curves back towards the base of the flower and the wings project about 0.25 cm beyond the standard.

The flowers rarely all face in the one direction, two from the same point often being at right angles to each other.

The ripe turgid seed pod is black and is rhomboid-oval in shape. Its base is still surrounded by the withered calyx and, at the other end, is the short upturned remnant of the style. The pod contains two olive-green seeds more than 1 cm long and 0.4 cm wide. Along almost the whole length of the curved upper edge of the seed is a prominent scar (hilum) marking where the seed separated from the stalk attaching it to the pod,

**FLOWERING TIME.** Midwinter to early spring.

**HABITAT.** This plant flourishes in widely differing habitats. It grows in sandy loam on the banks of streams, on the edges of eucalyptus forests and rain-forests. It is common on dry stony hillsides but has also been found growing in deep sand on the slopes of a large forested dune.

**DISTRIBUTION.** This plant is found from as far south as Kunghur in northern New South Wales to as far north as Double Island Point in Queensland.

**GENERAL REMARKS.** This is also a very floriferous and handsome plant. It is being cultivated successfully in New South Wales but at present is not available from native plant nurseries in Queensland.

### Rusty Hovea

**RUSTY HOVEA** (*Hovea pannosa*). *Pannosa* is a Latin adjective which means having the appearance or texture of felt. It describes the lower surfaces of the leaves of this plant.

**DISTINGUISHING FEATURES.** The loose pubescence covering the lower surfaces of the leaves and its rusty brown colour, the large leathery leaves and the rusty-woolly pods distinguish this hovea.

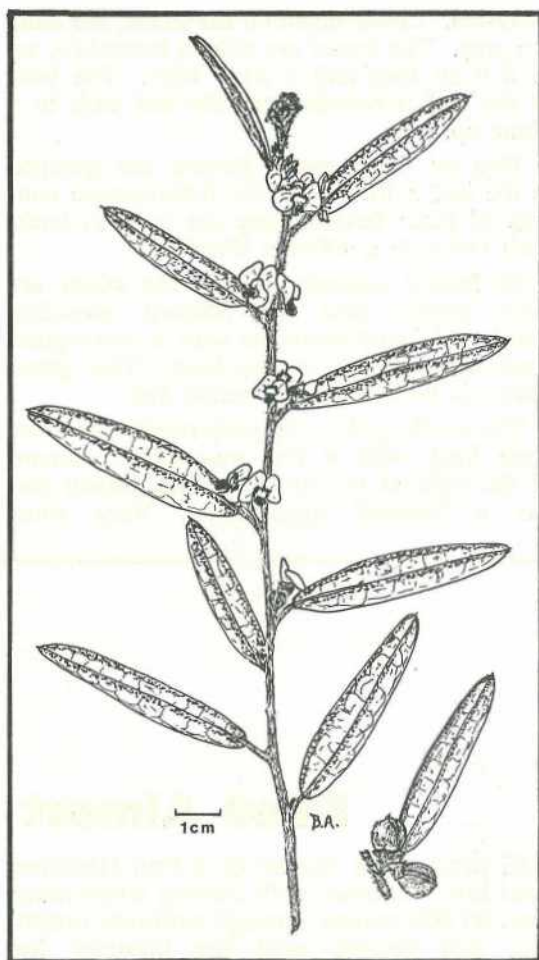

Rusty hovea (*Hovea pannosa*).

**DESCRIPTION.** This is an open spreading shrub 1.5 to 1.8 m high, branching at or near ground level, or with several stems arising from ground level. The stems tend to arch downwards at the ends and the leaves are mainly towards the ends of the stems; the basal parts are bare.

The leaves mainly lie with the upper surfaces facing up to the sun. These surfaces are slightly rough to the touch because of the raised lateral veins. The mid vein is deeply sunken on the upper surface of the leaf. This surface is dark green but not shiny. The lower surfaces are velvety. On leaves in the flowering portions of the branches, the indumentum is

rusty-red. Lower down on the stems, the hairs are grey. The leaves are oblong-lanceolate, up to 8.8 cm long and 1.3 cm wide. The base of the leaf is rounded and the leaf ends in a blunt tip.

Two or three sessile flowers are grouped in the leaf axils. When the inflorescence consists of three flowers, they are back to back, each facing in a different direction.

In freshly opened flowers, the wings are deep purple, and the reflexed spreading standard is reddish-purple with a rectangular apple-green blotch at the base. This green colour is bordered by a purple line.

The sessile pod is obliquely ovoid and about 1 cm long, with a tiny up-curving remnant of the style at the tip. The firm brown pod has a 'frosted' appearance. Very short

'crimped' hairs form a dense cover on the outer surface. Inside are two kidney-shaped smooth black seeds.

**FLOWERING TIME.** Winter to early spring.

**HABITAT.** This plant is found in open eucalyptus forests. It grows in stony or sandy soil on rocky hills and among sandstone boulders.

**DISTRIBUTION.** In Queensland, the distribution of this plant is very patchy. It has been found in the southern part of the State from Brisbane to as far west as Chinchilla. It also grows in the Eidsvold district, on the Blackdown Tableland and the Carnarvon Ranges. The only other State in which it is found is New South Wales where it is reported to be widespread.

---

## Sired Almost 86 000 Calves

THE productive career of a Poll Hereford beef bull, credited with having sired more than 85 800 calves through artificial breeding, has ended, said the Minister for Primary Industries (Hon. V. B. Sullivan, M.L.A.).

He said that the bull, Wahroonga Ian, who had achieved world standing as a prolific sire, died soon after his retirement from the Primary Industries Department's Artificial Insemination Centre at Wacol, Brisbane.

Collection of semen from Wahroonga Ian had begun in November 1962 when he was 15 months old and had been continued for almost 11½ years.

In that long period of production, 143 000 doses, of which 80% was suitable for deep-freezing and sale, were collected.

'This is believed to have set a world record and certainly is the peak effort for a sire at an Australian A.I. Centre,' Mr. Sullivan stated.

'A fertility survey carried out on Wahroonga Ian showed that, from every four cows inseminated with his semen, three produced calves.

'This high degree of fertility and the strength and thriftiness of the calves sired made him extremely popular with both graziers and dairy farmers, the latter using his semen extensively for dairy beef production.'



# Grain Sorghum at Dalby

by W. BOTT, Agriculture Branch.

GRAIN sorghum has been the main summer crop of Dalby grain lands for many years. The area under the crop increased tenfold to 12 000 ha between 1942 and 1968.

A succession of dry winters and good summers beginning in 1969 saw a sharp lift in sorghum plantings which rose to a peak of 48 000 ha in 1971. The area grown in the Wambo Shire has since stabilized at about 44 000 ha per year.

Sorghum hybrids with their 15 to 20% better yield potential were introduced into the district in 1962-1963, but overall yields did not rise significantly. This was because of expansion of the crop onto less suitable soils and lack of attention to crop water and fertility needs. Many growers on good soils who pay due care to these factors regularly achieve yields of 50% above the district average.

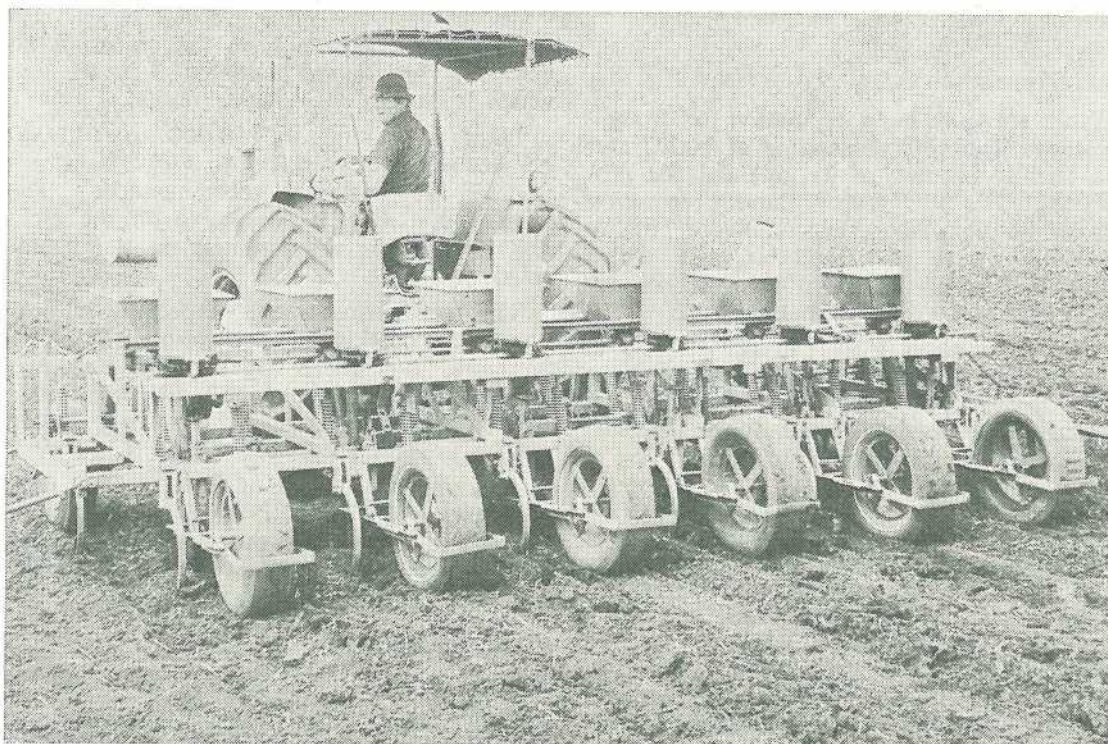

*Presswheels, especially on row planters, are quickly gaining favour among Dalby district sorghum growers. Mr. W. Bach, of Macalister, planted 200 ha of sorghum with this machine in the summer of 1973-74.*



TABLE 1  
GRAIN SORGHUM PRODUCTION—WAMBO SHIRE

Year	Ha	Tonnes	Yield (t/ha)
1942-43	1.2	1 591	1.27
1945-46	2.3	3 151	1.38
1950-51	4.7	6 996	1.49
1955-56	6.2	13 312	2.13
1960-61	8.8	18 235	2.06
1965-66	10.9	23 281	2.13
1970-71	32.9	59 679	1.81
1971-72	48.0	123 166	2.56
1972-73	37.3	78 490	2.10

### Soils

Grain sorghum is adaptable to a wide range of soil types provided that plant populations are matched to the water content of the particular soil. The plain soils with their excellent water-holding capacity are best suited to the crop. Other soils, in descending order of productivity, are brigalow plain, softwood scrub and box forest. Sorghum is not recommended on light sandy or solodic soils.

### Land Preparation

While sorghum has a reputation for drought resistance it is very demanding of both water and fertility because of its potential for production. For this reason, land preparation should be centred on accumulation of an adequate reserve of subsoil moisture, which is essential to tide the crop over the hot dry spells that occur in a normal summer.

A reserve of at least 1 m of wet soil at planting time should be the aim. Planting on lesser depths of wet soil becomes a gamble. A satisfactory seedbed will generally be provided by the normal pre-planting fallow.

### Planting

Time and rate of seeding are vital in growing sorghum. In a crop with heavy water needs, it may seem logical to have the period of maximum need coincide with the wettest months of December and January. However, such timing can pose problems as midsummer heatwaves can damage embryo heads.

Midge is another factor influencing planting time as early crops generally escape serious midge damage.

Very early or very late planting is limited by slow and erratic germination because of cold soil in early plantings and by the risk of frost damage in late plantings. A trend towards clearcut early and late plantings of summer crops including sorghum began a few years ago. This trend has disappeared during recent erratic seasons. Had this trend towards early planting in October, and late planting in December-January with no midseason crop continued it would have greatly assisted in midge control by interrupting breeding of the pest.

Planting rates have a direct bearing on the success of the crop, particularly in dry seasons. Over-planting could have been largely responsible for low yields in the early days. Upwards of 12 kg of seed per hectare were planted in those days.

Planting rates have been reduced during the last 20 years and row planting has been gaining favour, especially in the Kupunn area. Row planting allows inter-row cultivation, and also is believed to foster better use of soil moisture.

These factors have been the object of an extension programme initiated 3 years ago which is currently producing results.

Plant populations of 50 000 to 100 000 per hectare, requiring 2.2 to 4.5 kg seed per hectare are currently recommended. The higher population is acceptable on the plain and lower rates are essential on the lighter soils.

The use of presswheels, especially on row planters, is quickly gaining favour. These give a more regular emergence of seedlings especially in non-mulching soils and when seedbed moisture is doubtful. They should not be used in very wet conditions.

A double-row layout of two 17.5 cm rows at intervals of 87 or 105 cm is used by some growers in an effort to overcome the problem of irregular seed drop when standard combines are planting small seeds at low rates.

### Crop Rotations

Sorghum, with its exacting pre-cropping and post-cropping fallow needs, often ties up the land for more than a year so it has been considered a change-over crop. Until the recent run of good summers, it was unusual to find sorghum grown on the same land in



successive years. While the practice is unlikely to become widespread, it indicates that, when moisture is adequate, fertility can be restored by the use of fertilizers.

District farmers are now well aware of the nitrogen tie-up occurring when stubble remains in the soil at planting time. Planting such land is seldom attempted without adequate nitrogen fertilization.

### Harvesting

Open (reel) front headers are standard equipment on Dalby district farms so harvesting standing sorghum crops presents few problems. Sorghum fingers and bat reels are widely used.

Salvaging badly lodged crops can be difficult. Growers who have corn fronts for their headers have used them in lodged row-planted crops for better grain recovery. Even partial lodging poses a problem as the crop must be cut low with consequent overloading of threshing and separating gear.

The crop is bulk handled.

Grain sorghum is subject to deterioration in storage if the moisture content exceeds 12%.

### Stubble Feeding

Grain sorghum stubble has been well regarded by stock owners ever since the crop first appeared in the district. During recent dry spells, sorghum stubble has met increased demand as the roughage component for lot feeding and has been widely used with molasses and urea supplements for maintaining cattle. To give an idea of its value, it sold at 20 to 25c a bale on the farm in the winter of 1973.

Although it has not been reported in this district, sorghum stubble can cause prussic acid poisoning. This is most likely to occur in early planted crops that contain regrowth. Such regrowth is reputed to be most dangerous when affected by drought or frost.

### Irrigated Sorghum

Grain sorghum was the most widely irrigated summer crop when irrigation became popular in the Dalby district in the late 1960s. It yielded this position to soybeans in the summer of 1972-73. The area of irrigated sorghum reached a peak of 800 ha in 1969-70. Interest

in the crop began to decline with the collapse of prices when the drought broke in that year.

Irrigators consider that a crop must have a gross margin in excess of \$125 per hectare to be profitable. As the average local irrigated sorghum yield lies between 4½ and 7½ tonnes per hectare, the crop is unable to meet this requirement when the price falls below \$33 per tonne. For some so far unexplained reason, the peak yields achieved by Central Downs irrigators appear to be beyond the reach of local growers.

Grain sorghum prices paid during the last 5 years are shown in Table 2.

TABLE 2  
DOLLARS PER TONNE FARM SIDING

Year	January	April	July	October
1969	36	40	44	40
1970	26	25	32	34
1971	30	26	34	30
1972	30	28	32	42
1973	40	35	58	55

### Certified Seed

A few experienced farmers have grown Queensland Certified Sorghum Seed in this district for several years. Between 50 000 and 100 000 kg of seed, mainly of the popular Texas 610 variety but including Early Kalo, Pioneer 846 and Zulu, were grown during the 1960s. Production reached a peak in the summer of 1970-71 when four growers planted 140 ha of Texas 610, Texas 671 and Pioneer 846 for a yield of 170 000 kg of seed.

Although irrigation stabilized production on some farms, serious contamination problems were encountered the following year. Tightening isolation requirements to deal with this problem has led to the virtual cessation of Certified Seed production in the district.

### Varieties

The first large-scale plantings of hybrid grain sorghums were made in 1962 and by the following year hybrids made up 50% of all plantings.

Texas 610 then became the most popular variety with Alpha always well to the fore. Alpha is favoured in northern parts of the district where stock enterprises dominate and where the variety has the reputation for giving



better stubble feed. Claims that it is a more reliable grain producer under adverse conditions are not supported by trial results. Texas 610 has lost some popularity in recent years because it is prone to lodging.

Table 3 shows the area planted to the more popular varieties in recent years.

TABLE 3

AREAS OF GRAIN SORGHUM VARIETIES—WAMBO SHIRE

Variety	1968-69 ha	1971-72 ha
Alpha .. ..	2 760	9 080
DeKalb C42 .. ..	N.A.	3 560
DeKalb E57 .. ..	3 040	4 360
Pioneer 846 .. ..	4 120	2 360
Texas 610 .. ..	6 920	7 040
Texas 626 .. ..	920	3 360
Yates NK 212 .. ..	220	5 760
Other varieties .. ..	14 340	9 680
<b>Total .. ..</b>	<b>22 320</b>	<b>45 200</b>

The sorghum varietal picture has become confused in recent years by the number of new varieties released. In an effort to clarify the situation, the Department regularly conducts district varietal trials so recommendations can be restricted to the few best early, mid-season and late varieties available.

### Pests

Midge is the most damaging pest encountered. Late crops are generally the worst affected though early irrigated crops may not escape. Midge were not very active during the dry summers of the late 1960s but many thousand hectares of the big crops grown during the last three seasons have needed spraying with two or three treatments.

Aphids often occur in huge numbers, mainly in the throat of the plant. Although this can cause poor extrusion of heads, chemical control is not justified. Aphids can also be numerous in developing heads, particularly when midge spraying has reduced the population of predators.

Heliothis sometimes cause appreciable damage right throughout from the seedling to the grain-fill stages. While grub damage at shot blade stage causes growers concern, control is not warranted. Larval activity in heads does not normally need treatment but some crops were severely damaged during the heliothis flare-up in the 1972-73 crop with some treatment being necessary.

The other pests of developing grain, the yellow peach moth and sorghum head caterpillar, have not yet assumed pest proportions in the Dalby district.

Cutworms and armyworms occasionally attack seedling sorghum and can ruin stands unless promptly treated. False wireworms can also cause trouble in early plantings on stubble land.

Grasshoppers are not generally troublesome, but in the 1973-74 season more than 10 000 ha of crops in the district were sprayed to control the spur-throated species. Seed-harvesting ants can be a problem particularly in heavy soils where preventive seed treatment is recommended. Mice and birds, mainly galahs and cockatoos, complete the list of pests troublesome in grain sorghum.

### Diseases

Lodging could vie with midge as the biggest hazard faced by sorghum growers. While this trouble can be the result of diseases such as charcoal and fusarium rots, it is more often due to death of the plant by desiccation with consequent weakening of stems. There appear to be varietal differences in standability, but in poor seasons most varieties succumb.

The most obvious remedy for lodging, apart from selection of varieties with a reputation for good standing, is to provide good conditions and pay close attention to plant populations.

Although grain sorghum is prone to a wide range of diseases ranging from pre-emergence and seedling rots through leaf diseases and stalk rots to head and covered smuts, these have not been of great importance to growers in this district.

As most sorghums are hybrids, the seed of which has been adequately treated, the incidence of kernel smut, some leaf diseases and pre-emergence rots is low. Moreover, most emergence problems are linked with early plantings which, because of slow germination in cool soil, expose the seed to these dangers for longer periods.

Leaf diseases, including sugarcane mosaic, rust, blight, bacterial streak and stripe and Athracnose, can be responsible for serious reduction in active leaf area in wet seasons.



Most popular varieties are resistant to the damaging red stripe form of sugarcane mosaic disease.

Smuts are seldom a problem as seed treatment minimizes the seed-borne kernel smut. The soil-borne head smut is unlikely to be troublesome unless sorghum is regularly grown in the same land in successive seasons.

Head blast is caused by stress, mainly heat stress during the early head-forming stage of growth. Affected heads are brown on emergence and set no grain.

Root failure can occur when no useful rain follows emergence and secondary roots are unable to penetrate the dry surface soil. Although primary roots are capable of sustaining plants to an advanced stage they cannot provide adequate anchorage and plants may lodge. A somewhat similar condition can result from hormone herbicide damage.

### Weeds

Fierce thornapple (*Datura ferox*), commonly called stramonium, is the sorghum grower's costliest weed. This weed has come into prominence in the last four seasons with the increase in summer plantings, the spread of seed during floods and the weed's resistance to all but the heaviest rates of herbicides.

As grain will not be accepted for export unless it is completely free of datura seed, growers are now attacking the weed more vigorously.

Mintweed (*Salvia reflexa*), annual urochloa (*Urochloa panicoides*) and stink grass (*Eragrostis cilianensis*) can be troublesome in crops grown in scrub and light soils. Barnyard millet (*Echinochloa crus-galli*) has become a serious weed on heavy soils in badly drained situations.

The insidious Johnson grass (*Sorghum halepense*), which has gained a foothold on many roadsides in recent wet summers, cannot be overlooked as a weed of sorghum. The main problem with this species is as a genetic contaminant of seed crops. In this role, it has been largely responsible for elimination of local Certified Seed production.

Wild oats can be a nuisance in early crops but growers are aware of the problem and take it into account when selecting areas for early sorghum.

A host of other species can be troublesome according to soil and season, but most can be dealt with by routine farm practice.

### Marketing

The crop has faced marketing problems ever since it was first traded in quantity.

First steps towards orderly marketing were taken in 1947 with the issue of an export licence by the then Minister for Agriculture and Stock and organization of a voluntary pool by the Queensland Co-operative Milling Association.

The Grain Sorghum Marketing Board took charge of marketing from its formation in 1956 until, through lack of support by south Queensland growers, the Act was amended in 1965 restricting the jurisdiction of the Board to Central Queensland.

The local crop was then marketed through normal trade channels until 1969-70 when a big crop faced a disastrous market situation. The Queensland Graingrowers' Association Grain Export Committee was formed in that year to alleviate this problem.

This Committee, in co-operation with the State Wheat Board whose receipt, storage and export facilities it uses, has operated successfully ever since. The contribution made by this Committee in achieving reasonable returns from recent big crops must be acknowledged.

### Future

Further increases in the sorghum area around Dalby cannot be foreseen except temporarily. In fact, any change is expected to be in the other direction. The recent threefold increase in the sorghum crop has been due to five successive poor winter seasons combined with a buoyant export grain market. A return to normal seasons is expected to lead to a return to traditional winter crops with a consequent reduction in the area available for sorghum.

Little change in crop agronomy is expected other than a continuation of the current trend towards row planting and lower seeding rates. An increase in the use of fertilizers, particularly nitrogen, is expected as growers come to appreciate the nutrient demands of the crop. Sorghum has already been found to be less responsive to phosphorous than winter crops.



# Brucellosis-Tested Swine Herds (As at June 13, 1974)

## BERKSHIRE

Bishop, N. H., Three Moon, via Monto  
 Clarke, E. J. & Son, "Kaloona Stud", Boonah  
 Cochrane, S., "Stanroy", Felton  
 Crawley, R. H., Rockthorpe, Linthorpe  
 H. M. State Farm, Numinbah  
 H. M. State Farm, Palen Creek  
 Handley, Est. J. L., "Meadow Vale", Lockyer  
 Handley, G. R., "Locklyn" Stud, Lockyer  
 Kimber, E. R., Tarella, M.S. 805, Mundubbera  
 Ludwig, A. L., "Beau View" Stud, Cryna, via Beaudesert  
 Neuendorf, W., M.S. 794, Kalbar  
 Queensland Agricultural College, Lawes  
 Research Station, Hermitage  
 Rosenblatt, G., Rosevilla Biloela  
 Westbrook Training Centre, Westbrook

## LARGE WHITE

Ashwell, J. & B., "Green Hill", M.S. 465, via Cambooya  
 Ballon, E. E. & E. MacLagan  
 Barrier Reef Islands Pty. Ltd., Hayman Island  
 Barron Bros., "Chiltern Hill", Cooyar  
 Batterham, P. & N., Raby Park, Ingelwood  
 Beutel, G. R. and Son, Brookdale Stud, M.S. 786, Boonah  
 Bishop, N. H., "Three Moon", via Monto  
 Bool, A. R. and B. E., Rossvale, Crow's Nest  
 Briskey, R. G. and M. J., Wallingford, Pittsworth  
 Brosnan, D. J., "Betafield", Mt. Murchison, via Biloela  
 Cauley, J. R., M.S. 918, Toowoomba  
 Cauley, T. P., M.S. Jondaryan 444, Rosalie  
 Clegg, J. A. & M. A., "Karoma" Stud, Mundubbera  
 Coleman, C. J., Merriland Stud, Britannia Station, Charters Towers  
 Corney, F. D. and E. C. W., Pagel, Tara  
 Cotter, N. J., "Olaroy", Goomeri  
 Craig, K. F., "Echoes", Bancroft, via Monto  
 Dean, G. F. & A. M. Home Cr., Wooroolin  
 Department of Aboriginal and Island Affairs, Cherbourg  
 Diete, E., Ingoldsby, 4343  
 Duckett, R. and L. M., Fairview, Capella  
 Duncan, C. P., "Colley", Flagstone Creek, Helidon  
 Duncan, J. A. & B. L., Ma Ma Creek  
 Dunlop Meats Pty. Ltd., Coondulla, Robertson Pk., Murray Upper  
 Eagle, D. R. & J. A., "Walurga", 134 Hogg St., Toowoomba  
 Fisher, J. & L., Lyndhurst, Jimbour  
 Flegler, T. C., Wongabeena, Dalby  
 Fletcher, L., "Par-en-eri" Stud, M.S. 806, Mundubbera  
 Forster, I. S. & D. E., 112 Drayton Rd., Toowoomba  
 Fowler, K. J. & B. D., "Kenstan", M.S. 195, Pittsworth  
 Fowler, K. P., Northlea Stud Farm, 156 Hogg St., Wilsonton, T'ba  
 Franke, K. H. and B., "Delvue" Stud, Cawdor  
 Freeman, W. A., "Trevlac", Rosewood  
 French, A., "Wilston Park", Pittsworth  
 Gosdon, T. C. & E. A., "Naumai", Dalby  
 Graham, T., Dungleigh, Highfields  
 Grayson, D. G., Wodalla, Killarney  
 Harwood, L. B., Cobar, Tara  
 H. M. State Farm, Numinbah  
 Head, G. A., M.S. 825, Ipswich  
 Hinchcliffe, D. F. & R. K., "Oakview", Milman, 4702  
 Hockings, J. & M., "Quambi", Kumbarilla  
 Hudson, R. F. & V. D., "Rondel", Hogg St., Wilsonton, Toowoomba  
 Jones, K. B. & I. R., "Cefn" Stud, Clifton  
 Kajewski, C. & D. I., "Glenroy", Glencoe, via Toowoomba  
 Kanowski, A., "Exton", Pechey  
 Kimber, E. R., "Tarella", M.S. 805, Mundubbera  
 Kruger, V. F. & B. L., "Greyhurst", Goombungee  
 Kuhl, V. and C. A., "The Mounts", M.S. 222, Oakey  
 Le Gros, W., "Elourea Stud", Marburg  
 Little, R. S., P. M. & G. W., "Glengarry", Jimbour  
 Maranoa Stud Piggery, Mitchell  
 Marsden, M., "Fernflat", Canaga  
 Marsh Pastoral Co., Brymaroo  
 Mathieson, K. N., "Iderway", Gayndah  
 Philip, R. J. and M. M., Boolarong Stud, Elimbah  
 Postle, R. S., G. C. & Son, "Yarallaside" Stud, Pittsworth  
 Queensland Agricultural College, Lawes  
 Quilter, P. E., Paga Paga Piggeries, Postman's Ridge  
 Radel, V. V., "Braedella" Stud, Coalstoun Lakes  
 Rosenblatt, G., Rosevilla, Biloela

## LARGE WHITE—continued

Research Station, Biloela  
 Ruge, A. F. & V. M., "Alvir" Stud, Biggenden  
 Sharp, G. H. & I. E., "Al-Lester" Stud, Woowoonga, Biggenden  
 Sharp, D. W. & L. J., "Arolla", Lavelle, Q., 4357  
 Smyth, R., Barambah Rd., Goomeri  
 Ward, R. J., "The Plateau", Mulgildie  
 Willdo Farming Co., Southbrook  
 Willet, L. J., "Wongalea", Irvingdale  
 Williamson, K., Cattermul Ave., Kalkie  
 Withcott Stud Piggery, Rowbotham St., Toowoomba  
 Wolfenden, C. B. & J., Rossmoya

## TAMWORTH

Kanowski, S. E., Pinelands, via Crows Nest

## WESSEX SADDLEBACK

Douglas, Mrs. W. S. & Son, "Greylight" Stud Goombungee  
 Jurgensen, R. H. and R. R., Kildare, M.S. 1065, Boonah  
 Smith, C. R. & Son, "Belton Park", Goombungee

## LANDRACE

Ashwell, J. & B., "Green Hill", M.S. 465, Cambooya  
 Ballon, E. E. & E. MacLagan  
 Barrier Reef Islands Pty. Ltd., Hayman Island  
 Batterham, P. & N., Raby Park, Ingelwood  
 Bertolotti, F. E. J. & N. I., "Mascotte", Wallumbilla  
 Bishop, N. H., "Three Moon", via Monto  
 Bool, R. A. and B. E., Rossvale, Crow's Nest  
 Brosnan, D. J., "Betafield", Mt. Murchison, via Biloela  
 Cauley, J. R., M.S. 918, Toowoomba  
 Cauley, T. P., M.S. Jondaryan 444, Rosalie  
 Clegg, J. A. & M. A., "Karoma" Stud, Mundubbera  
 Coleman, C. J., Merriland Stud, Britannia Station, Charters Towers  
 Crowle, N. & D., Cooranga North, 4408  
 Dean, G. F. & A. M. Home Cr., Wooroolin  
 Diete, E., Ingoldsby, 4343  
 Dowling, A. M. & C. M., "The Anchor", Wutul, via Toowoomba  
 Duckett, R. and L. M., Fairview, Capella  
 Dunlop Meats Pty. Ltd., Coondulla, Robertson Pk., Murray Upper  
 Fisher, J. & L., Lyndhurst, Jimbour  
 Fisher, J. & L., Wongabeena, Dalby  
 Flegler, T. C., Wongabeena, Dalby  
 Fletcher, L., "Par-en-eri" Stud, M.S. 806, Mundubbera  
 Forster, I. S. & D. E., 112 Drayton Rd., Toowoomba  
 Fowler, K. J. & B. D., "Kenstan", M.S. 195, Pittsworth  
 Fowler, K. P., "Northlea", 156 Hogg St., Wilsonton, Toowoomba  
 Fowler, N. E. P. & M. P., c/- Kewpie Enterprises, Kingaroy  
 Gosdon, T. C. & E. A., "Naumai", Dalby  
 Graham, T., Dungleigh, Highfields, 4352  
 Grayson, D. G., "Wodalla", Killarney  
 Harwood, L. B., Cobar, Tara  
 Hinchcliffe, D. F. & R. K., "Oakview", Milman, via Rockhampton  
 Hockings, J. & M., "Quambi", Kumbarilla  
 Hudson, R. F. & V. D., "Rondel", Hogg St., Wilsonton, Toowoomba  
 Jones, K. B. & I. R., "Cefn" Stud, Clifton  
 Kajewski, C. & D. I., "Glenroy", Glencoe, via Toowoomba  
 Little, R. S., P. M. & G. W., "Glengarry", Jimbour  
 Maranoa Stud Piggery, Mitchell  
 Marsden, M., "Fernflat", Canaga  
 Marsh Pastoral Co., Brymaroo  
 Nielsen, L. R., "Sunny Hill", Ascot, via Greenmount  
 Peters, L. A., "Moonlight", Bongeen  
 Philip, R. J. and M. M., Boolarong Stud, Elimbah  
 Quilter, P. E., Paga Paga Piggeries, Postman's Ridge  
 Radel, R. M., Turua Stud, Biggenden  
 Rosenblatt, G., Rosevilla, Biloela  
 Ruge, A. F. & V. M., "Alvir", Biggenden  
 Sharp, D. W. & L. J., "Arolla", Lavelle, Q., 4357  
 Smith, E. J., "Ayrvale" Stud, Borallon  
 Trout, L. B. and L. J., "Caminda", Crawford, Kingaroy  
 Willdo Farming Co., Southbrook  
 Willet, L. J., "Wongalea", Irvingdale  
 Williamson, K., Cattermul Ave., Kalkie



# Fruit Ripening Rooms . . .

## Hints on Equipping and Operating

by J. B. WATKINS, Physiologist.

THE main requirement for a ripening room is equipment for controlling temperature.

For some applications, there is little problem in selecting the type of equipment required. A banana ripening room located in a tropical area and operating over a temperature range of 14.5 to 20°C would need refrigeration. A papaw ripening room operating at 30 to 32°C during winter would certainly need heaters. A citrus degreening room operating at 28 to 29°C would require heaters during the winter months.

However, for intermediate ripening temperatures, for example, a tomato ripening room operating at 19 to 21°C, both heating and cooling equipment could be required at different times. This would apply more particularly to highland areas, such as the Granite Belt, where wide differences can occur between day and night temperatures.

In deciding the type of equipment required, it must be remembered that ripening itself can produce a considerable amount of heat.

The heat produced by a tonne (1 000 kg) of tomatoes ripening at 20°C could maintain a room, insulated with two layers of sisalation, at about 2.5°C above the outside air temperature. This heat produced will impose an additional load on refrigeration but will reduce the load on heaters.

### Importance of Temperature

It is important that ripening room temperatures should be maintained within the recommended range. Excessively high temperatures can cause poor colour development in tomatoes and bananas, mould growth and off-flavours in avocados and poor flavour development in pears.

Temperatures lower than those recommended can encourage mould growth in citrus and papaws, poor colour development in papaws and will slow down the ripening rate of all fruit. If the temperature falls below about 13°C, fruit such as papaws, tomatoes and bananas can suffer chilling injury.

## Heating and Cooling Capacity

The pulp temperature of fruit to be ripened may be outside the desired ripening range when placed in the room. This pulp temperature must be adjusted to the ripening temperature before the introduction of ethylene gas. As the greatest demand on the temperature control equipment can be during this initial adjustment, the capacity of this equipment must be adequate for the task.

A heating capacity of approximately 4 000 kJ/tonne/hour (4 000 BTU/ton/hour) will raise the fruit pulp temperature approximately 1°C per hour. A heater of approximately 1 200 watts would be adequate for 1 tonne of fruit. To lower the pulp temperature 1°C per hour, a cooling capacity of 4 000 kJ/tonne/hour would be required.

## Air Circulation

The required heating or cooling rates can be achieved only if a fan provides adequate air circulated throughout the room and if as much surface area of the package as possible is exposed to the circulating air. The fan must operate continuously and have a fan capacity of at least the room volume per minute. For example, a room 3 m x 3 m x 3 m (27 m<sup>3</sup>) would require a fan capacity of approximately 27 m<sup>3</sup> per minute.

## Thermostat

The thermostat (temperature sensing element) that controls the on-off cycles of the temperature control equipment is located where the return air stream can flow freely over the sensing element. A convenient location is within the space between the load in the room and the end wall adjacent to the temperature control equipment.

## Humidity

The recommended relative humidity for ripening rooms is 85 to 90%. The need for a humidification system depends on the room temperature. For temperatures up to about 21°C, no humidity control is needed. For temperatures above this point, such as in trickle degreening of citrus and in papaw ripening, some humidification system is needed to maintain the required humidity.

A simple method of raising the humidity is to place a shallow tray of water in front of the fan. In the average grower ripening room, a tray approximately 1 m square will provide sufficient surface area of water to raise the humidity effectively. Although this system does not give a positive control of the final level reached, the equipment needed to control humidity is not justified unless the room is specifically used for degreening citrus by the trickle system.

## Metering of Ethylene

Although other ripening agents such as acetylene (generated from carbide in water) and coal gas have been used, ethylene is the preferred gas. It is far more effective than acetylene and safer to use as the amount required can be accurately metered into the room. Any ripening room explosions that have occurred in the past have almost always, if not invariably, been through the use of gases other than ethylene.

Ethylene is purchased in 0.9 m<sup>3</sup>, 1.8 m<sup>3</sup> and 9 m<sup>3</sup> capacity cylinders. The 0.9 m<sup>3</sup> or 1.8 m<sup>3</sup> sizes are those commonly used by growers. To dispense the ethylene, a cylinder key and flow meter are required.

The flow meter is calibrated in fractions of a cubic foot per minute. As an example of how to calculate the amount required, suppose a room to be 3 m x 3 m x 3 m, giving a volume of 27 m<sup>3</sup> (approximately 950 cubic feet as 1 m<sup>3</sup> = 35.3 cubic feet). The ethylene concentration recommended is 1 part in 5 000 parts of air and the room is charged with this concentration three times a day.

The amount for each charge is  $\frac{1 \times 950}{5\,000}$ ,

which is approximately 0.2 cubic feet a minute. To meter out 0.2 cubic feet, the flow meter could be set on 0.2 and run for 1 minute or on 1.0 and run for 12 seconds and so on. The flow meter is equipped with a button which must be held down for the predetermined time to dispense the required amount of ethylene.



If flow meters are converted to metric calibrations, it will probably be litres per minute. As 1 m<sup>3</sup> is 1 000 litres, the calculation for the required amount of ethylene would be—

a room 3 m x 3 m x 3 m = 27 m<sup>3</sup>  
(27 000 litres)

for a 1 in 5 000 concentration, each  
27 000

charge would be  $\frac{27\ 000}{5\ 000} = 5.4$  litres

The gas is admitted to the room through tubing fed through the wall at some convenient point, making sure that room air is circulating freely past the entry point. Before each addition of ethylene, the room must be thoroughly ventilated by leaving the door open for 5 to 10 minutes with the fan running. The fan should be left running at all times.

### Specific Requirements

**SPECIFIC REQUIREMENTS FOR CONTROLLED RIPENING.** The following section lists the requirements for each of the commodities commonly held in ripening rooms, together with other relevant comments. The desired humidity is 85 to 90% and the ethylene

concentration 1 part in 5 000 parts of air, unless otherwise stated. Ethylene to be added three times per day.

### Tomato

Temperature 20°C, acceptable range 18 to 24°C. Above 24°C, colour development may be poor; below 20°C ripening rate is slower. Chilling injury will occur if green fruit is held for prolonged periods below approximately 13°C.

For best quality, fruit must be mature green when harvested but as this stage is often difficult to judge, some immature fruit may be included. Any fruit that takes longer than 6 to 7 days to begin colouring is suspect in quality and should be discarded. Periodic sorting to remove coloured fruit and return green fruit to the room is usually unavoidable.

### Banana

**TEMPERATURE.** 15 to 22°C, depending on variety and ripening time required. The following table is a guide to the ripening temperature required to achieve ripe fruit at a particular time for the Cavendish and related varieties.

DAILY FRUIT PULP TEMPERATURE IN °C

Fruit required in:	Day 1	Day 2	Day 3	Day 4	Day 5	Day 6	Day 7	Day 8
3 days .. ..	19	19	19	..	..	..	..	..
4 days .. ..	18	18	15.5	15.5	..	..	..	..
5 days .. ..	16.5	16.5	16.5	16.5	15.5	..	..	..
6 days .. ..	16.5	16.5	15.5	15.5	15.5	14.5	..	..
7 days .. ..	15.5	15.5	15.5	15.5	15.5	14.5	14.5	..
8 days .. ..	14.5	14.5	14.5	14.5	14.5	14.5	14.5	14.5

The recommended temperature for Lady Finger is 22°C.

**HUMIDITY.** In the initial stages of ripening, there is generally little problem in controlling humidity in the 85 to 90% range, but, once the first trace of colour appears, the humidity should be reduced to 70 to 75% by leaving the door slightly open. If the humidity remains high, the skin of the bananas becomes tender and liable to split and the fruit develop weak necks (breaking at the stem end of the fingers).

**ETHYLENE CONCENTRATION.** 1 part of ethylene in 10 000 parts of air.

### PROCEDURE FOR RIPENING BANANAS—

- 1 Load the room ensuring adequate air spaces in the storage pattern to achieve temperature control.
- 2 Take the pulp temperature of the fruit (the pulp temperature must be within the desired temperature range before ethylene is added to the room).
- 3 Determine when the fruit is to be sold and select a ripening procedure from the temperature chart.

- 4 Adjust the pulp temperature of the fruit to the required level.
- 5 Add ethylene as required.
- 6 Check pulp temperature and progress of ripening twice a day and adjust the thermostat setting as required.
- 7 Adjust ventilation when the first trace of yellow appears.
- 8 Ripen fruit to about one-third colour (more green than yellow) before removal to extreme summer or winter conditions.

**SOME COMMON FAULTS IN RIPENED BANANAS.** While some faults are due to the condition of the fruit on arrival, ripening troubles are mainly the result of using incorrect temperatures or humidities, badly constructed and leaky rooms, or under-gassing.

Dull colour is caused by any of the following:—

- Winter-grown fruit subjected to low temperatures in the plantation or chilled during transport.
- Pulp temperatures allowed to rise above 23°C.
- Relative humidity too low in the early stages of ripening.
- Fruit removed from the ripening room too early, especially in cold or hot weather.

Poor flavour and rapid deterioration of ripe fruit may be the result of any of the following:—

- Pulp temperatures too high during ripening.
- Fruit removed from the ripening rooms too early in hot weather.
- Bananas exposed to high temperatures in retail shops.
- Humidity too high in the later stages of ripening.
- Fruit received in a heat-affected condition.

Flecking beginning before the fruit is full yellow may be caused by any of the following:—

- Pulp temperatures too high during ripening.
- Fruit removed from the rooms too early.

- Fruit received in a heat-affected condition.

Failure of the pulp to ripen completely although the appearance is good may be due to any of these faults:—

- Fruit is inherently 'rubbery'.
- Pulp temperatures too low during ripening.
- Fruit removed from the ripening rooms too early.

When fully ripe the peel is soft, easily broken or splits. This may be due to humidity being too high in the later stages of ripening. Development of black end and anthracnose may be because the fruit was not treated with a recommended fungicide at packing.

Fruit shrivel at the stem, ripening slows, peel shows excessive blackening of even minor injuries, shrinkage excessive. These effects may be caused by the humidity being too low.

### **Papaw**

**TEMPERATURE.** 30 to 32°C. Fruit will ripen at a lower temperature but the high temperature is chosen to retard the growth rate of ripe fruit rots.

**HARVESTING MATURITY.** Winter fruit are harvested when the first tinge of colour appears at the blossom end or at some later stage. During warmer weather, fruit may be harvested at a slightly earlier stage. However, as fruit ripening behaviour can be extremely variable from grower to grower, these remarks are a guide only and are subject to exceptions.

**ROOM HEATERS.** In place of electric heaters, kerosene stoves are sometimes used for papaw ripening rooms. These stoves give off some ethylene and additional ethylene must **not** be added to the room. Temperature control is difficult and only trial and error can determine an approximate stove setting to maintain the 30 to 32°C temperature range.

Papaws ripened at high temperatures in the absence of ethylene can develop abnormal texture (fruit rubbery). If similar results are obtained using kerosene stoves, the grower is advised to install electric heaters and to use ethylene.



## Pear

TEMPERATURE. 18 to 20°C. If the fruit is to be held in the rooms until ripe, 18°C is used. Otherwise, 20°C for 48 hours is sufficient to initiate ripening in pears. Subsequent shelf life may be reduced by prolonged periods in the ripening room. If fruit is to be held in the rooms until ripe (for example, canning pears), the rooms must be ventilated thoroughly before each addition of ethylene to reduce any carbon dioxide accumulation. It has been shown that accumulated carbon dioxide can cause core breakdown in Queensland-grown William's Bon Chretien pears.

## Citrus (Degreening)

TEMPERATURE. 27 to 30°C.

HUMIDITY. Much of the rind injury that can occur during degreening is caused by low humidity; the so-called 'gas burn' is a typical example. Many existing citrus degreening rooms are operated without any temperature or humidity control. Rind injuries can and do occur periodically in such rooms.

TRICKLE DEGREENING. The installation of trickle degreening is justified for the following reasons:—

- 1 Positive control of temperature, humidity, ventilation rate and ethylene concentration.
- 2 Reduced degreening time.
- 3 Because of the low ethylene concentration (approximately 15 p.p.m.) used, the electricity commission regards trickle rooms as a non-hazardous situation, provided a fail-safe switch is installed. Consequently, less expensive control facilities are required. (Flame-proof equipment required in a hazardous situation can be costly.)
- 4 Rind injuries are reduced to a minimum through effective humidity control.
- 5 Convenience. Once in operation, the room can run continuously without attention. In the 'shot' method, the room must be ventilated and recharged with ethylene three times each day.

## Plum

TEMPERATURE. 20°C. Recommendations for controlled ripening of plums apply only to the Santa Rosa variety. Fruit can be harvested when one-third to half colour and held for 48 hours in the room before marketing.

## Peach

TEMPERATURE. 20°C. Peaches are prone to a disorder known as 'woolliness' if overstored in an unripe state. Such fruit, on removal from storage, colours normally but softens to a dry, mealy texture and insipid flavour. The storage life can be extended by up to 50% by holding green mature peaches in a ripening room for 48 hours at 20°C before storage.

## Avocado

TEMPERATURE. 16 to 18°C. Controlled ripening at this temperature until eating ripe ensures the minimum amount of fruit rotting together with best flavour. Removal to higher temperatures when only partially ripe will increase the amount of ripe fruit rot.

## Miscellaneous Fruits

Inquiries have been received on controlled degreening of rockmelons, capsicums and passion fruit. Experimental attempts to colour these varieties have been unsuccessful. Rockmelons cannot be coloured without concurrent softening. Green capsicums treated with ethylene became yellow around the stem end but the desired red pigment failed to develop. Gassing also increased stem end rotting. Although passion fruit coloured to some extent at high temperatures (30 to 32°C), weight loss and consequent shrivelling were too severe in the absence of effective humidity control.

# Farming Districts Need Bush

## Fire Brigades

LULLED into a sense of false security by the laws of averages and chance, most farmers in highly developed agricultural areas such as grain, sugar-cane and market gardening, fail to understand the need to form Bush Fire Brigades.

Instead, they rely on their own disorganized efforts and a distant town Fire Brigade when fire occurs on their properties.

Fire in a village is so uncommon that, in small centres, weeks, months or even years may lapse between fires. In the towns and cities, the number of fires is small in proportion to the number of places in which fire could occur. But no one ever suggests that urban Fire Brigades should be abolished. Indeed, the householder and businessman pays his fire insurance premium and again, in his rates and taxes, a further contribution to cover the possibility of loss and to maintain a Fire Brigade service in his locality.

In pastoral areas, Bush Fire Brigades play an active part in abating fire hazards, preventing fires and extinguishing or containing wild fire in the grass and bush lands. They also handle the occasional vehicular and structural fires that occur. In these areas, the policy is obvious: it is better to be prepared and lose a little than to do nothing and perhaps lose the lot.

Why then are the residents of many agricultural areas so reluctant to engage in self-help by forming their own Bush Fire Brigade? Are they confused because of the title of such an organization? Like the rose, a fire brigade by any name is a welcome sight. Do they

by N. A. SCOTT, Rural Fires Board.

really think 'it can't happen to me'? Or do they pin their faith on the fireman and appliances of the nearest urban Fire Brigade situated at a township a long way from their properties? This final attitude reflects great credit on our Urban Fire Brigades but demonstrates a lack of credibility on the part of the farmer.

The men of the Urban Fire Brigade Services in Queensland have never been found wanting in an emergency, but they would be the first to admit that they are not supermen. They cannot be in two places at once.

Time is important if fire fighting is to be effective. Fire quickly develops in intensity and a big part, if not all, of a house is damaged or destroyed in less than 10 minutes. How long would it take for the fire-fighting appliance to reach your property?

The more intense the fire, the greater the quantity of water required. Fire-fighting appliances can carry only a limited supply of water and few properties are equipped so that additional water is readily and easily available.



Many other factors also operate against the firemen. They may not know the exact location of the property or the shortest or fastest road. The property may be unnamed and the fire out of sight from the road. They may be held up by stock, by an accident, a vehicle failure. The crew may not be big enough to handle a large intense fire.

No matter what happens, the firemen will not fail to give their best, but this is not always sufficient.

A long hard look at an agricultural district reveals these facts—

- Any structure whether it is a house or a shed costs more than a comparable building in a town or city, because of labour, travel and carting materials.
- Domestic electrical and gas appliances, curtains, furnishings and human habitation give a rural home a constant fire danger rating similar to that of any suburban residence.
- If each item were taken separately, the out-buildings on a property would have a constant fire danger rating similar to that of a small manufacturing business in a suburban area. But because vehicles, machinery, fuels, chemicals, industrial electrical and gas appliances, stored grain, hay and other materials stand cheek by jowl, the constant fire danger rating is much higher in rural areas than in a similar type area in a town or a city.
- The high constant fire danger rating of the outbuildings increases the fire danger rating of the residence.

### **Greater fire danger**

Without going into further details, it is obvious that the living and storage area on a property contains a much higher capital value and a higher constant fire danger rating than a similar sized area in a city suburb.

On the remainder of the property, a seasonal and variable fire danger rating comes from grass, weeds, pasture, crops and other vegetation. This is influenced by external factors, roadsides, travellers, adjoining properties, lightning strike and so on.

During a normal summer and even more during an abnormal summer, the increased rural fire danger rating adds to the constant fire danger rating of the residential area.

Taking all features into consideration, it can be considered that each farm of more than 40 ha contains a fire danger rating which is the equivalent of a normal city or town suburban residential block.

Bush Fire Brigades are voluntary organizations whose members are a group of landholders from a locality or district. The members elect brigade officers thus ensuring leadership should a fire occur.

Brigade members are not called upon to do any more than they did before the brigade was formed which was, and is, to help a neighbour in distress. But they do the same things more efficiently because of previously selected leadership. There is also an increase in willingness because each member is covered by compensation in case of injury, equipment used is covered by insurance and members have legal indemnity to protect them in their activities.

### **Fire-fighting equipment**

The average farm is well-stocked with machinery and equipment that can be used for fire-fighting: tractors, ploughs, pumps, misters. The list is almost endless. If, however, it is desired to make certain equipment more efficient, parts, hoses and other items may be obtained from the Rural Fires Board at subsidized rates. Pumping equipment, if required, is also subsidized.

Brigade equipment does not need to be elaborate or sophisticated. Half a dozen knapsack sprays, a couple of small power pumps, or perhaps beaters, rakes and hoes, quickly on the spot can prevent a fire from spreading, can save a building, a crop or a pasture.

Leadership is an important part of any fire activities and fire-fighting in particular. A small group working under direction is more effective than a larger, willing, but disorganized group in subduing a fire, in saving a life, in avoiding unnecessary damage, in carrying out salvage. Bush Fire Brigades provide organization, can you afford not to be a member?



Bush Fire Brigades and Urban Fire Brigades supplement each other's activities. Urban Fire Brigade officers are willing to instruct and receive instruction from Bush Fire Brigade members so that everyone gains knowledge and brigades can, if need be, work together in efficient harmony.

Compensation and the various insurance covers on vehicles and equipment are provided by the Rural Fires Board at no cost to brigade members.

Bush Fire Brigades receive no direction about the type and standard of equipment they should have available and, because the man-

agement of the brigade's activities is autonomous, a brigade can secure as little or as much as the members themselves decide.

Bush Fire Brigades are formed to give rural people an organized fire protection that is not otherwise available to them. The brigades also ensure that the individual does not bear the brunt of possible personal loss when he engages in the vital community activity of fighting any type of fire.

The Rural Fires Board, P.O. Box 37, Brisbane, North Quay, Q., 4000, welcomes inquiries. Do yourself and your community a good turn by getting further information from the Secretary.

---

## Papaw Dieback and Calcium Deficiency

SIMILARITIES in symptoms suggested that calcium deficiency might be the cause of dieback in pawpaws, said Mr. R. E. Barke, Senior Plant Physiologist in the Queensland Department of Primary Industries.

Mr. Barke was speaking to about 40 growers at a field day at the Department's Redlands Horticultural Research Station. Growers came from Yarwun, Yeppoon, and Near North Coast centres.

He said that, last year, growers had suffered a serious outbreak of dieback, and this had given new impetus to the search to find its cause.

In the Redlands experiment, young papaw trees had been planted in polythene drums of crushed quartz rock, and had been regularly fed all the required nutrients. However, differing levels of calcium (80, 8, 4 and 0.5 parts per million) had been supplied.

Symptoms first appeared in the trees fed 4 and 0.5 parts per million 4 weeks after treatments began, and some plants had died within 6 weeks. Symptoms did not show in those given 80 parts.

Symptoms common to dieback and calcium deficiency were: bunching of the crown, yellowing and drooping of the leaves, turning over and death of the growing point, death of the fine veins, appearance of grease spots on the stems, and the development of translucence in the leaves.

Some symptoms of the two disorders, however, differed. The main one is that the plant died rapidly from dieback while death was slow from calcium deficiency. With dieback, a brown spot appeared on the stem but with calcium deficiency, a split occurred; with dieback, a brown streak appeared on the stem but with calcium deficiency it appeared in the pith only.

These differences might be due to the method of artificially creating the deficiency.

Many outbreaks of dieback had occurred in a hot, dry period after heavy rain. It was thought that the rain had damaged the root system which then was unable to obtain the plant's nutrient and moisture needs.

Papaws growing in soils regarded as high in calcium still could show deficiency symptoms, the problem being due to the plant having difficulty in absorbing and translocating the calcium.

While the theory of calcium deficiency being the cause of dieback had not been proved conclusively by the investigation, evidence suggested that growers should look closely at the calcium status of their soils.

Mr. Barke said this could improve by decreasing the acidity of the soil by liming, increasing the organic matter content, providing better drainage and avoiding the use of acid fertilizers and excessive applications of potassium.





# Anne COOK'S farm home

*WHEN shopping, it's a good idea to buy your meat last of all, especially in the warmer weather that will soon be upon us.*

By doing this, you'll avoid the risk of the meat 'going off', as it can quickly spoil in the heat. Avoid also leaving meat in closed cars or shopping bags for a long time as this may cause it to deteriorate. If long journeys are necessary, the safest course is to put the meat in a cooler in the car.

As soon as you get the meat home, put it in the refrigerator. If it is to be used within a few days, it should be unwrapped and put in the chiller part of the refrigerator. In this section, the refrigerator runs at temperatures above 0°C. Wrapping paper doesn't allow the cool air to reach the meat easily. The meat may be covered loosely on the top with a piece of greaseproof paper. If the meat is to be kept longer, it's best stored in the deep freeze part where temperatures are below 0°.

Meat and meat products are sometimes sold in plastic bags. If it's intended to put the meat in the deep freeze part of the refrigerator, it may be safely left in the bag. But if it is to be put in the chiller, the meat should be removed from the bag.

Meat 'going off' quickly passes through three stages if it is not kept cool enough. These are—

- Slimy. This meat has grey sticky or slippery areas which can be wiped off. The slime indicates that the meat is nearing the end of its shelf life, and should be either cooked quickly or frozen in the deep freeze. If frozen it should be used quickly after thawing.
- Slimy, sour smell and slightly rancid. This meat is nearer the end of its shelf life but is still useable. It can be washed in a solution of one dessertspoonful of vinegar in 500 millilitres of water. Particular attention should be paid to folds and cuts. Fatty portions should be removed to get rid of rancidity.
- Putrid. This meat with offensive and bad odours should be discarded.

Cooling meat immediately you get it home reduces losses and thus saves the housewife money. Knowing how to treat meat that is in the early stages of 'going off' will also help to avoid wastage.

—W. R. RAMSAY, Senior Meat Quality Officer.



### Handy Home Hints

WHEN one of the children goes alone to spend a holiday with a friend or relative, tape a list of contents of his suitcase inside the lid. Then, when the youngster or his hostess pack for his return home, the items can easily be checked and ticked off as they are packed. In this way, nothing is left behind. Any extra possessions, such as a tennis racquet, a rug or a handbag can also be added to the list and checked off before departure. It does save finding a little windcheater hanging in a tree later or a pair of rain shoes still out in the laundry.

When making a button through shift, sew the bottom button on a small piece of elastic. The elastic will stretch and prevent the button pulling off when you bend.

A large bath towel is an investment for the laundry. Keep it exclusively for rolling up woollens to remove excess water. You'll find the garments dry much more quickly.

If you wish to put silk cord strings on a beach hat, bind each end firmly with plastic adhesive tape. It's easy to thread through straw, and keeps the cord from fraying.

When your jam is ready to be sealed in its jars, it's a good idea to place a string across the top of the jar before pouring in the melted paraffin wax. When you wish to remove the cap, lift the string and the seal will come out without any bother.

An ideal gift, especially for a pensioner, is a writing pad and set of envelopes stamped ready for postage.

If you grease the cup in which you measure treacle, honey or syrup, every drop will run out and there'll be no waste.



### **Feeding Babies**

SOMETIMES people think that bottle feeding baby just means putting the bottle in baby's mouth and letting it suck until it falls asleep. If this theory is put into practice, the baby will develop a poor sucking technique and will not gain adequate weight as bottles are left unfinished.

Babies instinctively have a good sucking technique but it takes very little 'education' for it to develop a bad sucking technique. Minutes sucking on a dry teat or even on a blocked teat rapidly tire a young baby and, instead of sucking, baby may chew on the teat for comfort rather than food.

It is mother's job during bottle feeding to make sure that the teat is always full of milk and doesn't get blocked. Bubbles should be constantly rising up through the milk as the

baby lets air replace the milk sucked out from the rubber teat. This means that the mother must be watching baby throughout the feed.

It is important that baby doesn't get overtired and fall asleep. Baby should be kept awake until all the feed is finished. It is impossible to burp a sleeping baby and so baby should be kept awake after the feeding to allow excessive air sucked into the stomach with the milk to come back up again.

If large bubbles of air are allowed to pass from the stomach into the intestine, the baby may experience bouts of pain or colic until all the air passes out through the back passage. Colic is painful and may badly disrupt baby's peaceful routine of eating and sleeping.

Milk is a near-perfect food and is the basis of baby's diet for the first 18 months to 2 years of life. Solid type foods need to be taken in large amounts to be able to replace milk in food value. There is no real need for baby to begin 'solid' feeding until about 9 months of life, but modern custom has decreed that additional food be commenced much earlier, at 6 to 8 weeks.

At this age few can eat from a spoon and most of the food is poked out. Gradually the nerve-muscle reflex concerned with this ability is developed and spoon feeding becomes successful.

Parents are inclined to be more interested in how much solid food baby takes rather than the amount of milk. This is an incorrect attitude to infant feeding as milk is essential for growth and development.

By 10 to 12 months, baby should be introduced to a feeding cup and by the age of 18 months the bottle should be replaced by a cup. Even then, mother must closely supervise the feeding time to ensure that baby is having adequate food during the time he is learning to feed himself.

Bottle feeding takes the entire concentration of mother and baby for it to be a happy and comfortable experience for both of them.

Any further information on this or other matters concerning children, may be obtained by personal communication with the Maternal and Child Welfare Service, 184 St. Paul's Terrace, Brisbane, or by addressing letters to Post Office Box 285, Broadway, Brisbane, 4000.



# Meat Pie Time



*Meat Pies. Here's an economical recipe, full of flavour, that makes up to a dozen individual pies.*

*MEAT* pies are favourites at any time that calls for hot, hearty meat dishes: savoury, flavoursome and filling. Beef pies are a warming sight in themselves with golden pastry hiding a succulent filling.

Modern commercial pastries, ready-made puff pastry and packaged shortcrust or flaky pastry mix, remove most problems from pie-making, even for the novice cook.

A pie can also be a meaty mixture topped with mashed potatoes or a savoury scone topping.

These recipes have all been kitchen-tested by Tess Mallos, food consultant to the Australian Meat Board.

The standard 8-oz. measuring cup and level standard spoon measures are used in the recipes.

## **Steak and Kidney Pie**

- 1½ lb. stewing beef
- ½ lb. beef kidney or 3 lamb kidneys
- 4 tablespoons flour
- 1½ teaspoons salt
- Freshly ground black pepper
- 1 onion, chopped
- 2 tablespoons dripping or butter
- 1½ cups beef stock
- 1, 12 oz. packet puff pastry

Trim excess fat from beef and cut into 1-inch cubes. Skin and core kidneys and dice. Mix flour with salt and pepper and coat beef and kidney pieces. Reserve remaining seasoned flour.

Sauté onion in fat until golden, remove to a plate, leaving fat in pan. Brown beef and kidney in fat, a few pieces at a time, transferring to a deep pie dish when browned. Return onion to pan and stir in remaining flour. Cook for 1 minute. Stir in stock and cook until thickened and bubbling. Pour over beef and kidney. Cover dish with a piece of foil and cook in a moderate oven, 325°F., for 1½ hours. Remove from oven and cool.

Roll out pastry to shape of the dish, but making it 1-inch larger all round. Cut off this extra inch. Moisten edge of pie dish with water. Place trimmed pastry strip around rim. Place a pie funnel or a china or metal egg cup in centre of meat in dish to support pastry. Brush pastry edge with water and lift pastry lid in position. Press edges to seal. Glaze with milk and cut a vent in the top. Cut leaves from pastry trimmings, place in position and glaze. Cook pie in a pre-heated hot oven, 450°F., for 15 minutes. Reduce heat to

moderate (350°F) and cook for a further 20-25 minutes. Serve immediately. Serves six.

Note:—Beef-kidney mixture may be cooked on top of range in a covered saucepan then transferred to pie dish when cool.



### Individual Meat Pies

- 1 lb. minced beef
- 1 onion, chopped
- 1 tablespoon dripping or butter
- $\frac{1}{2}$  cup flour
- 2 cups beef stock (use water and stock tablet)
- 1 teaspoon dried mixed herbs
- 1 tablespoon chopped parsley
- 1 tablespoon Worcestershire sauce
- Pinch nutmeg
- 1 teaspoon salt
- Pepper to taste
- 1 teaspoon Parisien essence
- 2, 12-oz. packets shortcrust or flaky pastry mix

Brown beef and onion in dripping until juices evaporate. Stir in flour and cook for 2 minutes, stirring constantly. Add stock and stir until mixture boils and thickens. Reduce heat and stir in herbs, sauce, nutmeg, seasoning and Parisien essence. Cover and cook gently for 10 minutes. Cool thoroughly.

Mix pastry according to packet directions. Roll out and cut 10 to 12 rounds to fit individual pie dishes. Roll out remaining pastry and cut rounds for tops. Divide meat mixture evenly into lined dishes and moisten pastry edges with water. Lift pastry tops into position and crimp edges to seal. Make a slit in the centre of each pie. Glaze with milk or egg yolk beaten with a little milk. Cook in a pre-heated hot oven, 425°F, for 10 minutes, reduce heat to moderate and cook for a further 15 minutes or until pies are golden. Serve immediately or cool and store in refrigerator for reheating later. Yields 10 to 12 pies.



*Steak and Kidney Pie. This is a hot, hearty and wonderfully appetizing sight on a winter's day.*

### Beef-vegetable Pie

- 1 lb. minced beef
- 1 onion, chopped
- 1 tablespoon butter or margarine
- 2 tablespoons flour
- $\frac{1}{2}$  cup tomato sauce
- $\frac{1}{2}$  cup beef stock (use water and stock cube)
- $\frac{1}{2}$  teaspoon mixed dried herbs
- 1 $\frac{1}{2}$  teaspoons salt
- Freshly ground black pepper
- 1, 1-lb. packet frozen mixed vegetables (or 1, 15-oz. can, drained)
- 1 packet shortcrust or flaky pastry mix

Brown beef and onion in butter or margarine. Cook until juices evaporate. Stir in flour and cook 2 minutes. Add tomato sauce, stock, herbs and seasonings. Stir until thickened and bubbling. Add frozen or drained, canned vegetables. Cover and cook gently for 10 minutes and allow to cool.

Mix pastry according to packet directions and roll out half to fit an 8-in. pie plate. Place meat mixture in lined plate and moisten pastry edge with water. Roll out remaining pastry to fit top and cover pie. Trim edge and crimp to seal. Glaze pie with milk or egg yolk beaten with a little milk. Prick top with fork. Cook in a pre-heated hot oven, 425°F, for 15 minutes, reduce to moderate and cook for a further 20 to 25 minutes. Serve immediately. Serves four.



# Two Leaf and Pod Diseases

## Ascochyta Disease

ASCOCHYTA disease (*Ascochyta phaseolorum*) occurs frequently in French beans in Queensland but rarely causes serious losses.

However, one or two severe outbreaks have been recorded under conditions particularly favourable for the disease. The fungus causing the disease is seed-borne.

Leaf spots are roughly circular, mostly 6 to 12 mm in diameter but up to 25 mm under favourable conditions. They are drab-grey to brown with a well-defined, dark-brown margin and may be marked by concentric rings giving a target effect. Eventually the centres of the spots dry and crack, leaving ragged holes. A close examination of the spots will reveal many minute, dark spore receptacles of the fungus embedded in the tissue. Dark, elongated, sunken areas are also produced on the stems and leaf stalks.

Infection from the floral remnants at the stem end may progress down into the pod to produce a dark, dry rot. A darkening of both sutures along the length of the pod is linked with this condition. Large, dark, spreading lesions may also be formed at other points on the pods, often originating at small superficial wounds.

The disease is favoured by cool, rainy weather, dissemination of the spores of the fungus occurring by raindrop splash. When plants have been grown in wind-exposed locations, the fungus gains entry through the wind-damaged plant tissues. In more sheltered areas, spots tend to be associated with rust pustules, insect feeding sites and other injuries.

Some tropical legumes are a source of infection for neighbouring French bean crops. The perennial nature of these pasture legumes may enable the fungus to become permanently established in a locality. Growers should ensure that beans are not planted near to these pastures.

In exposed areas, the establishment of windbreaks such as Barner grass will protect plants against wind damage and subsequent fungal attack.

As the fungus gains entry through rust pustules, the control of rust with fungicides is an important control measure. Seed harvested from a diseased crop should not be used in future plantings.

## Pleiochaeta Brown Spot

PLEIOCHAETA brown spot disease (*Pleiochaeta setosa*) is restricted in its occurrence to a few areas where French beans are grown on very light, sandy soils. Even here, it occurs only sporadically and seldom is the cause of much concern.

The fungus responsible is a wound pathogen only, and it has been shown that abrasion by sand particles during cyclonic winds apparently predisposes plants to infection.

On the leaves, reddish-brown spots rarely more than 2 mm in diameter occur. The centres of these spots may eventually fall out leaving ragged holes. Small, dark spots are produced on the veins on the undersides of the leaves. In some situations, leaf attack has been so severe that premature defoliation has occurred.

On the pods, slightly sunken spots with dark-brown to black centres and lighter-coloured, rust-brown margins are produced. These spots range from 1 to 2 mm in diameter and, in severe cases, may coalesce. Often these pods are unmarketable. Spotting of stems and flowers may also be evident.

Two weeds which have been shown to be alternative hosts of this fungus are streaked rattlepod (*Crotalaria mucronata*) and Gambia pea (*Crotalaria goreensis*). The disease is confined to light, sandy soils in the vicinity of these infected weeds.

Eradication of the alternative weed hosts with suitable herbicides is the most practicable means of controlling the disease.

— Plant Pathology Branch

Further information can be obtained from the nearest Plant Pathology office or by writing to the Director, Plant Pathology Branch, Meiers Road, Indooroopilly, Q., 4068.



# Diseases of French Beans - 6



*ASCOCHYTA DISEASE. Left: leaf spots. Above: pod spots.*

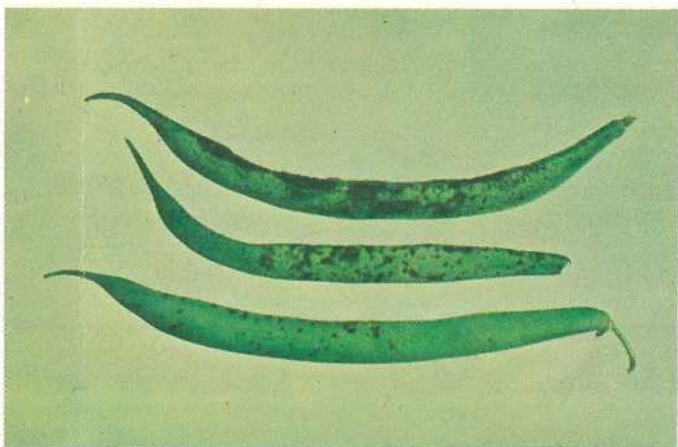
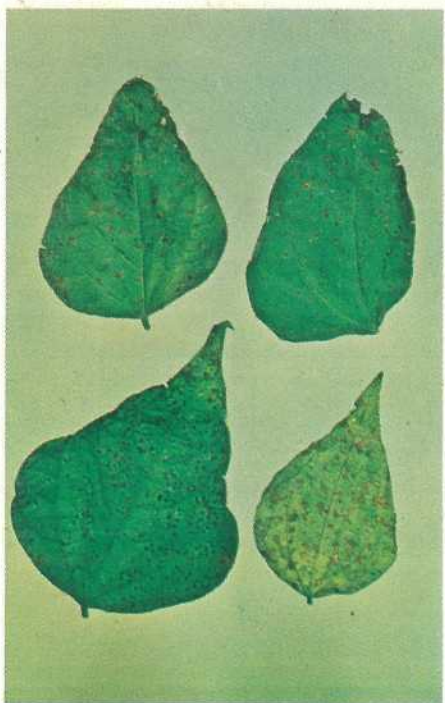

*PLEIOCHAETA BROWN SPOT DISEASE. Left: leaf spots. Above: pod spots.*